

**MYANMAR EXTRACTIVE INDUSTRIES TRANSPARENCY
INITIATIVE (MEITI)**

**EITI REPORT FOR THE PERIOD
APRIL 2014 - MARCH 2015**

OIL, GAS AND MINING SECTORS

March 2018



Table of Contents

INTRODUCTION	7
Extractive Industries Transparency Initiative (EITI)	7
EITI in Myanmar.....	7
Objective.....	7
Nature and extent of our work	8
1. EXECUTIVE SUMMARY	9
1.1. Revenue generated from the extractive sector	9
1.2. Production and exports	12
1.3. Scope of the data collection and reconciliation	16
1.4. Comprehensiveness and reliability of data	17
1.5. Summary of the reconciliation results.....	19
1.6. Findings and recommendations	27
2. APPROACH AND METHODOLOGY	28
2.1. Scoping Study.....	28
2.2. Data collection	28
2.3. Reconciliation and investigation of discrepancies.....	28
2.4. Reliability and credibility of data reported	29
2.5. Basis and period of reporting.....	32
2.6. Procedures for the management and protection of the collected data	32
3. CONTEXTUAL INFORMATION ON THE EXTRACTIVE INDUSTRY	33
3.1. Extractive sector in Myanmar	33
3.2. Oil and Gas sector	35
3.3. Mining sector.....	57
3.4. Budget process and public finance and revenues management reforms.....	89
3.5. Fiscal devolution	100
3.6. Revenues collection, revenues allocation and subsidies	102
3.7. Beneficial ownership	109
3.8. Audit and assurance practices in Myanmar	111
3.9. Contribution to the Economy	113
4. DETERMINATION OF THE RECONCILIATION SCOPE	116
4.1. Selection of payment flows.....	116
4.2. Selection of reporting entities	120

5. RECONCILIATION RESULTS	124
5.1. Payments of Oil & Gas companies	124
5.2. Payments of Gems and Jade companies	130
5.3. Payments of other minerals companies.....	138
5.4. Payments of Oil and Gas Transportations Companies:	145
5.5. Transfers from SOEs to MoPF	148
5.6. Production and Exportation:	149
5.7. Reconciliation between EITI data and other sources of information	160
5.8. Field visit verification	162
6. OTHER INFORMATION	163
6.1. Production and exports/Sold declared by SOEs	163
6.2. Government receipts from companies not selected in the reconciliation scope	163
6.3. Oil & gas transportation volume and tariff.....	165
6.4. Revenues from the sale of the State's production share.....	165
6.5. Transfers from SOEs to Government Agencies.....	168
6.6. Social Expenditures and Infrastructure Provisions.....	168
6.7. Quasi-fiscal expenditures	169
6.8. Loans and loan guarantees	169
6.9. Infrastructure provisions and barter arrangements	171
7. RECOMMENDATIONS	172
7.1. Governance of the extractive revenues	172
7.2. Management of the Gems and Jade sector.....	178
7.3. EITI implementation	180
APPENDICES	200
Appendix 1: Extractive companies profile.....	201
Appendix 2: Legal ownership	209
Appendix 3: Adjustments to Oil & Gas Sub-sector	225
Appendix 4: Adjustments to Gems & Jade Sub-sector	228
Appendix 5: Adjustments to Other minerals Sub-sector	233
Appendix 6: Production and export detail	235
Appendix 7: Reporting templates	238
Appendix 8: SOEs reconciliation sheets.....	239
Appendix 9: Payment flows description	244
Appendix 10: Detail of Licenses	248
Appendix 11: Award Process	249
Appendix 12: Standard Terms and Conditions of Oil and Gas contracts	250

Appendix 13: Oil & gas transportation volume and tariff	259
Appendix 14: Detail of Submission of the Reporting templates by extractive companies	261
Appendix 15: Breakdown of the social payments by beneficiary and by project	265
Appendix 16: Extractive Revenues 2014-2015 disaggregated by revenue streams ...	273
Appendix 17: Extractive Revenues 2014-2015 disaggregated by company	276
Appendix 18: Reconciliation sheets by company.....	278
Appendix 19: Situtaion of the Oil and Gas companies that did not submit Reporting Templates	279
Appendix 20: Bid criteria for the award of the Oil and Gas blocks	280
Appendix 21: Participation of ME2 in the mining Joint Ventures	281
Appendix 22: Gold in-kind debts of the Other Minerals companies due to ME2 as at 31 March 2015.....	282
Appendix 23: Persons contacted or involved in the 2014-2015 MEITI reconciliation ..	288

Glossary and abbreviations

ASM	Artisanal and Small-scale Mining
Bbl.	Barrel
BO	Beneficial Ownership
Bscf	Billion Scf
CD	Custom Department
IT	Income Tax
CSO	Central Statistical Organization
CSR	Corporate Social Responsibility
CT	Commercial Tax
DGSE	Department of Geological Service and Mineral Exploration
DHPP	Department of Hydropower Planning
DICA	Directorate of Investment and Company Administration
DMO	Domestic Market Obligation
DoM	Department of Mines
DPP	Directorate of Defence Procurement
EGSA	Export Gas Sales Agreement
EGTA	Export Gas Transportation Agreement
EITI	Extractive Industries Transparency Initiative
EPD	Energy Planning Department
EQEG	Environmental Quality Emission Guideline
EUR	Euro
FS	Financial Statements
GAAP	Generally Accepted Accounting Principles
GDP	Gross Domestic Product
GOUM	Government of the Union of Myanmar
GPOA	Gas Pipeline Operating Agreement
GPOA	Gas Pipeline Operating Agreement
IFAC	International Federation of Accountants
IFRS	International Financial Reporting Standards
INTOSAI	International Organisation of Supreme Audit Institutions
IOC	International Oil Company
IPRC	Improved Petroleum Recovery Contracts
IRD	Internal Revenue Department
IT	Income Tax
JV(A)	Joint Venture (Agreement)
Kg	Kilograms
km ²	Square kilometer
MAC	Myanmar Accountancy Council
MAS	Myanmar Accounting Standards
MATA	Myanmar Alliance for Transparency and Accountability
MCA	Myanmar Companies Act
ME	Mining Enterprise
MEB	Myanmar Economic Bank
MEC	Myanmar Economic Corporation
MEITI	Myanmar EITI
MEPE	Myanmar Electric Power Enterprise
MFRS	Myanmar Financial Reporting Standards
MGE	Myanmar Gems Enterprise
MGJEA	Myanmar Gems and Jewelry Entrepreneurs Association (MGJEA)
MIC	Myanmar Investment Commission
MICPA	Myanmar Institute of Certified Accountants
MIL	Myanmar Investment Law
MMK	Myanmar Kyats

Glossary and abbreviations

MMscf	Million scf
MNPED	Ministry of National Planning and Economic Development
MNRMC	Minerals and Natural Resources Management Committee
MOECAF	Ministry of Environmental Conservation and Forestry
MoEE	Ministry of Electricity and Energy
MOGE	Myanma Oil & Gas Enterprise (Ministry of Energy)
MONREC	Ministry of Natural Resources and Environmental Conservation
MoPF	Ministry of Planning and Finance
MPE	Myanmar Petrochemical Enterprise
MPPE	Myanmar Petroleum Products Enterprise
Mscf	Thousand scf
MSG	Multi-Stakeholder Group
MSMCE	Myanmar Salt and Marine Chemical Enterprise
MT	Metric Tons
n/a	Not applicable
n/c	Not communicated
OAG	Office of the Auditor General of the Union
OGPD	Oil and Gas Planning Department
Oz T	troy ounce
PAC	Public Accounts Committee
PCC	Performance Compensation Contracts
PFM	Public Finance Management
PSC	Production Sharing Contract
scf	Cubic Feet
SEE	State Economic Enterprise
SME	Small and Medium Enterprises
SOE	State-Owned Enterprise
THB	Thai Baht
ToR	Terms of Reference
Tscf	Trillion Cubic Feet
UMEHL	Union of Myanmar Economic Holdings Ltd.
US \$- USD	United States dollars

INTRODUCTION

Extractive Industries Transparency Initiative (EITI)¹

The Extractive Industries Transparency Initiative (EITI) is a global Standard to promote open and accountable management of natural resources. It seeks to strengthen government and company systems, inform public debates and enhance trust. In each implementing country it is supported by a coalition of governments, companies and civil society organisations working together.

The Extractive Industries Transparency Initiative (EITI) was first announced at the World Summit on Sustainable Development in Johannesburg in 2002 (the Earth Summit 2002) and was officially launched in London in 2003. EITI is currently being implemented in 51 countries in Africa, Asia, Europe and America.

The EITI Standard sets out the requirements which countries need to meet in order to be recognised, first as an EITI Candidate and ultimately as an EITI compliant country. The Standard is overseen by the international EITI Board, which comprises members from Governments, companies and civil society organisations.

EITI in Myanmar²

Myanmar joined EITI on instructions from its President at the end of 2012. Myanmar submitted its application to become an 'EITI Candidate' country to the EITI Board in May 2014. At its 27th meeting in Mexico in July 2014, the EITI Board approved Myanmar's candidacy application, and granted Myanmar until January 2016 to produce its first EITI Report.

Myanmar published its first EITI report for the period from April 2013 to March 2014 in December 2015.

On 19 December 2016, the Union Government formally appointed the Myanmar EITI Leading Committee composed of the Minister of Planning and Finance (MOPF) as Chair, the Minister of Natural Resources and Conservation and the Minister of Energy and Electricity as members, and the Deputy Minister of MOPF as Secretary. The Renaissance Institute was appointed as the National Coordination Office.

A new MEITI Multi-Stakeholder Group (MSG) was setup on 23 March 2017, comprising 7 Government representatives, 7 private sector representatives and 9 civil society representatives.

On 7 March 2017, the EITI International Board approved MEITI's request for extension of deadlines, setting 31 March 2018 as the deadline for the publication of its second EITI Report, and 1 July 2018 as the commencement date for their Validation.

Objective

The purpose of this Report is to reconcile the data provided by companies operating in the extractive sector (hereafter referred to as "Companies") with the data provided by relevant Government Ministries and Bodies (hereinafter referred to as "Government Agencies").

The overall objectives of the reconciliation exercise are to assist the Government of Myanmar in identifying the positive contribution that extractive sector is making to the economic and social development of the country and to realise their potential through improved resource governance that encompasses and fully implements the principles and criteria of the Extractive Industries Transparency Initiative.

¹ Source: <https://eiti.org/eiti>

² Source : <http://myanmareiti.org/what-eiti>

According to MSG's decision, the extractive sectors to be covered by this report are oil and gas, gems and jade, other minerals and pearls.

Nature and extent of our work

We have performed our work in accordance with the International Auditing Standards applicable to related services (ISRS 4400 Engagements to perform agreed upon procedures regarding Financial Information). The procedures performed were those set out in the terms of reference as set out in the Request for Proposal and approved by MSG.

The reconciliation procedures carried out were not designed to constitute an audit or review in accordance with International Standards on Auditing or International Standards on Review Engagements and as a result we do not express any assurance on the transactions beyond the explicit statements set out in this report. Had we performed additional procedures other matters might have come to our attention that would have been reported to you.

The report consists of eight (8) chapters presented as follows:

- Executive summary;
- Methodology and approach to the reconciliation process;
- Description of the contextual information on the industry;
- Determination of the reconciliation scope;
- Reconciliation results of reported data;
- Other information disclosed; and
- Findings, recommendations for improvement of future reconciliation processes.

Reported data disaggregated by individual companies, Government Agencies and revenue streams, are included as Appendices to the report. The amounts in this report are stated in Myanmar Kyat (MMK), unless otherwise stated.

Our report incorporates information received up to 19 January 2018. Any information received after this date has not been included in the report.

1. EXECUTIVE SUMMARY

This report summarises information about the reconciliation of fiscal and non-fiscal revenues from the extractive sector in Myanmar as part of the implementation of the Extractive Industries Transparency Initiative (EITI). In addition, this report includes the reconciliation of revenues collected by the State-Owned Enterprises (SOE) from extractive companies and cash flows contributed by SOE to the State's budget.

As decided by the MSG during their meeting held on 2 October 2017, the extractive sector covered by the present reconciliation includes three sub-sectors Oil and Gas, Gems and Jade, other minerals and pearls.

1.1. Revenue generated from the extractive sector

The receipts reported by the Government Agencies during the period from 1 April 2014 to 31 March 2015, after reconciliation, are summarised as follows:

Direct payments made by extractive companies³

Total revenue collected from the extractive companies amounted to MMK 3,408,193 million⁴ for the fiscal period 2014-2015. The revenue stream from the extractive sector is composed of 85% of revenues from Oil & Gas sub-sector (including O&G transportation) while gems & jade and other minerals represent 11% and 4% respectively. The detail of these revenues streams is set out in the table below:

Table n°1: Myanmar Extractive revenues by sub-sector

Figures in million MMK

Sub-sector	Tax revenues ⁵	Non-tax revenues ⁶	Social payments ⁷	Total revenues	%
Oil & Gas	148,794	2,230,830	4,810	2,384,434	70%
Oil & Gas transportation	295,452	197,820	4,500	497,772	15%
Gems & Jade	55,682	331,329	18	387,029	11%
Other Minerals	27,510	94,473	2,865	124,848	4%
Pearl	-	14,110	-	14,110	0.4%
Total	527,438	2,868,563	12,193	3,408,193	100%

Graphic 1: Relative size of revenue stream and sub-sectors

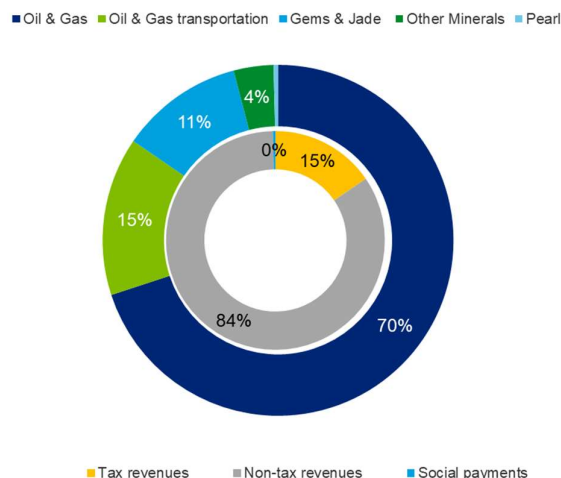

³ This does not include transfers and payments made by SOEs to the State Budget Account

⁴ Source: EITI Data reported by Government Agencies after adjustments

⁵ Tax revenues include the extractive companies' tax payments and customs duties

⁶ Non-tax revenues include the revenues collected by the SOEs

⁷ The social payments include the extractive companies' in-kind and cash social contributions

EITI figures indicate that in fiscal year 2014/15, oil, gas and mining SOEs were responsible for 83% (MMK 2,839,610 million) of revenues received from extractive companies. The largest of them, the Myanmar Oil and Gas Enterprise (MOGE) alone accounted for 71% of extractive revenues.

The detail of revenues by Government Agency and by source of revenues is set out in the table below⁸:

Table n°2: Collection of extractive revenues

Figures in million MMK

	Revenues received from extractive sector ⁹					
	SOE	DoM	Forest Department	IRD-Customs	Social payments	Total
Oil & Gas sub-sector	2,428,650	-	-	444,246	9,310	2,882,206
<i>Sale of the state's share of production – Production Split</i>	1,434,592	-	-	-	-	1,434,592
<i>Oil and Gas companies</i>	796,238	-	-	148,794	4,810	949,842
<i>Oil and Gas transportation companies</i>	197,820	-	-	295,452	4,500	497,772
Gems & Jade sub-sector	331,329	-	-	55,682	18	387,029
<i>Sale of the state's share of production - Sale Split</i>	122,866	-	-	-	-	122,866
<i>Gems and Jade companies</i>	208,463	-	-	55,682	18	264,163
Other Minerals sub-sector	65,520	28,423	530	27,510	2,865	124,848
ME1	4,982	7,633	-	1,969	21	14,605
<i>Sale of the state's share of production - Sale Split</i>	1,677	-	-	-	-	1,677
<i>Companies under ME 1</i>	3,305	7,633	-	1,969	21	12,928
ME2	32,342	309	46	1,463	2,206	36,367
<i>Sale of the state's share of production - Sale Split</i>	30,391	-	-	-	-	30,391
<i>Companies under ME 2</i>	1,952	309	46	1,463	2,206	5,976
ME3	28,195	17,323	48	9,165	638	55,369
<i>Sale of the state's share of production - Sale Split</i>	25,608	-	-	-	-	25,608
<i>Companies under ME 3</i>	2,587	17,323	48	9,165	638	29,761
Unilateral disclosure	-	3,158	436	14,912	-	18,507
Pearl sub-sector	14,110	-	-	-	-	14,110
<i>Sale of the state's share of production</i>	14,008	-	-	-	-	14,008
<i>Pearl companies</i>	102	-	-	-	-	102
Total	2,839,610	28,423	530	527,438	12,193	3,408,193

The payments made by the extractive companies to the respective SOEs include the non-tax revenues (signature and production bonuses, royalties on sales, royalties on production, production split, sale split, licence fees, data fees).

The payments made by the extractive companies to IRD include the Income Tax, the Commercial Tax, the withholding tax and stamp duties and the payments to the Custom Department include the customs duties.

The payments to DoM include royalties, signature bonus/application fees, dead rent fees and licence fees and the payments to the Forest Department include the land rental fees and environmental / plantation fees.

The revenues received from the extractive sector disaggregated by revenue streams and by company are presented in Appendix 16 and Appendix 17 of the report. The reconciliation sheets by company are presented in Appendix 18.

⁸ Source: EITI data reported by Government Agencies after reconciliation adjustments

⁹ Source: EITI data reported by Government Agencies after reconciliation adjustments

Transfers made by SOEs

The total revenues collected by oil, gas and mining SOE's for the fiscal year 2014/2015 amounted MMK 2,839,610 million, of which MMK 1,188,859 million was transferred to MoPF (IRD, Customs and Treasury Department), MMK 332,946 million to OGPD (formerly EPD), MMK 7,415 million to Central Committee and MMK 3,227 million to DoM. During the same fiscal year, the six-upstream extractive industry SOEs transferred MMK 1,352,591 million into these "Other Accounts". MOGE alone reported to have transferred MMK 1,179,203 million into its Other Accounts.

Table n°3: Transfers of revenues collected by SOE's

Figures in million MMK

SOE	Amount received by SOE	Transfer from SOE to Gov Agencies during the fiscal year 2014/15					Transfers to SOE other accounts	Total
		IRD-Customs	OGPD (formerly EPD) ¹⁰	Central Committee	DoM	State contributions		
MOGE	2,428,650	745,888	332,946	-	-	286,106	1,179,204	2,544,143
MGE	331,329	75,741	-	7,415	-	61,495	112,395	257,045
ME 1	4,982	2,162	-	-	-	1,860	4,366	8,387
ME 2	32,342	5,607	-	-	3,227	5,346	22,320	36,500
ME 3	28,195	904	-	-	-	723	27,534	29,162
MPE	14,110	1,847	-	-	-	1,180	6,776	9,804
Total	2,839,610	832,149	332,946	7,415	3,227	356,710	1,352,594	2,885,041

The difference between the total amounts received by the SOEs and the total transfers made to MoPF, DoM and Other Accounts could be explained by:

- the expenditures made by the SOEs to cover the operational, administrative and investments expenses which are deducted from transfers to "other accounts"; and
- the state contribution and the income tax which are paid to IRD in 2014-2015 but calculated on the net profit realized in 2013-2014.

Details of the reconciliation of the transfers made by SOEs are presented in Sections 3.2.11 and 3.3.11 and in Appendix 8 of the report.

Government receipts from extractive sector

The extractive revenues net receipts collected by the Government for the fiscal year 2014/15 amounts to MMK 3,441,432 million. These revenues are mainly retained by SOEs in their "Other Accounts" as the company's own funds and for the purpose of its exclusive operations and capital needs. SOEs retained for the fiscal year 2014/15 an amount of MMK 1,352,591 million representing 39% of the total revenues-net receipts from extractive sector.

Table 4: Total Government Receipts from the Sector

Graphic 2: Government receipts

	Oil & Gas	Gems & Jade	Other minerals	Pearl	Total	%
Transfers to SOEs Other Accounts	1,179,204	112,395	54,219	6,776	1,352,594	39%
Tax revenues	444,246	55,682	27,510	-	527,438	15%
Transfers from SOEs to Gov Agencies	1,364,939	144,651	19,829	3,027	1,532,446	45%
Non-Tax revenues	-	-	28,953	-	28,953	1%
Total	2,988,389	312,727	130,511	9,804	3,441,432	100%

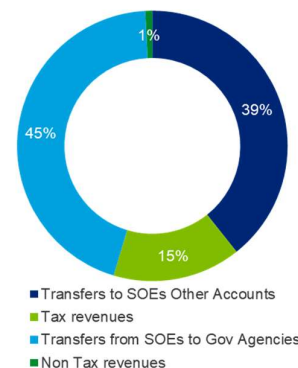

¹⁰ These transfers include the royalties, production and signature bonuses as reported by OGPD

Significance to Myanmar economy

According to the Central Statistical Organization (CSO), the Gross Domestic Product (GDP) from the extractive sector for 2014-2015 amounted to approximately MMK 4,797,494¹¹ million or 7% of the Country's GDP.

The extractive sector's contribution to the State's revenue amounted to MMK 3,408,193 million (20.6%)¹² in 2014-2015 of the Total revenues of the Union amounting to MMK 16,538,398 million¹³.

The entire sector's contribution to employment has not been made available to us. We understand that this information is not available at the level of the SOEs and Oil and Gas and mining departments. As declared in their reporting templates, the selected companies and SOEs employ directly about 37,314 individuals representing 0.2% of total Country's 2014-2015 labour force of 21.24 million¹⁴. The entire sector's contribution has not been provided.

As per the Central Statistical Organization, the value of exports from extractive sector amounted to US\$ 6,648.07 million and represents about 53.1% of the total export of the country¹⁵.

The charts below show the contribution from the extractive sector to the GDP, the State revenues and the exports figures for 2014-2015. More details are set out in Section 3.9 of this report.

Graphic 3: Macro-economic indicators for the extractive sector (2014-2015)

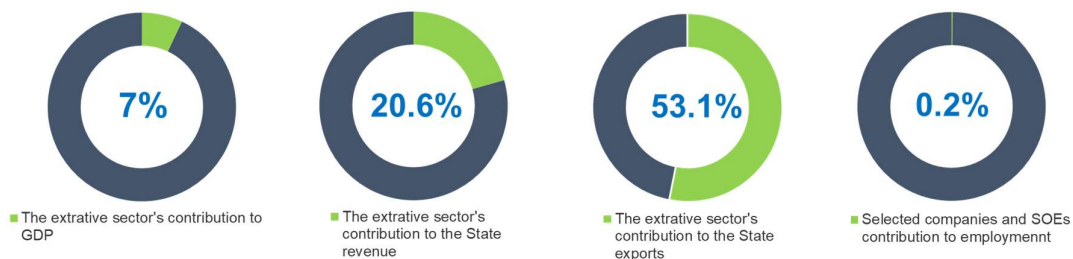

1.2. Production and exports

Oil and Gas

According to data reported by MOGE, 2,869,870 barrels of Condensate and 651,584 MMscf of Natural Gas were produced in offshore blocks and 1,744,317 barrels of Condensate and 645 MMscf of Natural Gas were produced in onshore blocks during the period from April 2014 to March 2015.

The value of petroleum and natural gas exported amounted to MMK 100,521 million (equivalent of US\$ 100 million) and MMK 4,798,711 million (equivalent of US\$ 4,821 million) respectively according to data submitted by MOGE. During the 2014-15 fiscal year, the average Brent price was US\$ 73.37 per barrel and US\$ 9,089.25 per MMscf.

94,799 MMscf of the gas was produced with a value of US\$ 597 million for the [domestic market](#) (DMO).

¹¹ Central Statistical Organization

¹² We note that we have not been able to obtain information about the actual executed Union revenues for the FY 2014-2015. Therefore, the calculation of the contribution to the revenues is made on the basis the budgeted revenues according to Union Budget Law 2015-2016

¹³ Total State revenues from Union Budget Law 2014.

¹⁴ Central Statistical Organisation

¹⁵ Source: selected monthly economic indicators CSO, March 2015.

Table n°5: Production and export of Oil and Natural Gas (In volume and value)

		Production			Exportation		
		Volume	Unit	Value (in million MMK) ¹⁶	Volume	Unit	Value (in million MMK)
Offshore blocks	Condensate	2,869,870	Barrels	209,572	1,376,527	Barrels	100,521
	Gas	651,584	MMscf	5,894,336	530,469	MMscf	4,798,711
Onshore blocks	Oil	1,744,317	Barrels	171,904	-	-	-
	Gas	645	MMscf	5,835	-	-	-
Total				6,281,647			4,899,232

Graphic 4: Production and export of Natural Gas, Condensate and Crude Oil (in million MMK)

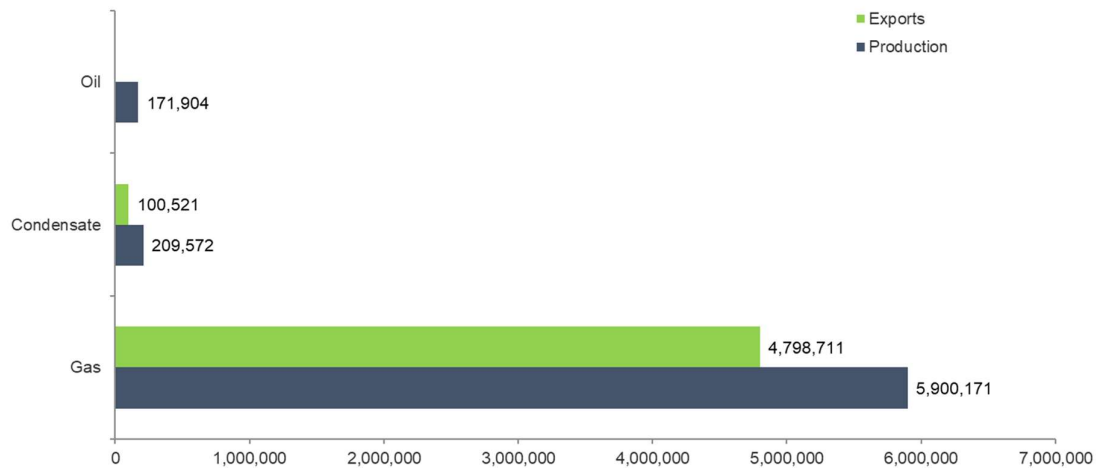

According to the data provide by MOGE, the State' Share of the Production of Oil and Gas is as follows:

Table 6: State' Share of Oil and Gas production in FY 2014-2015

	Offshore blocks		Onshore blocks		
	Volume (in Barrels)	%	Volume (in Barrels)	%	
Condensate / Oil	Production	2,869,870	100%	1,744,317	100%
	State Share	535,763	19%	215,256	12%
	Royalties	291,038	10%	78,275	4%
	Baseline payment (IPR/PCC)	-	-	601,203	34%
	Risk compensation (IPR/PCC)	-	-	360,365	21%
Gas	Production	651,584	100%	645	100%
	State Share	81,589	13%	-	-
	Royalties	53,867	8%	-	-
	Baseline payment (IPR/PCC)	-	-	617	96%
	Risk compensation (IPR/PCC)	-	-	28	4%

¹⁶ The estimation of the production value was calculated based on the average price of Condensate and Gas exports as declared by MOGE. For oil, the average Brent price 2014 (USD 99.02) was used for the estimation.

According to MOGE:

- the revenues collected from the Sale of the State's Share of production in offshore blocks amount to MMK 1,403,766 million which represents 59% of the total Oil and Gas revenues in FY 2014-2015;
- the revenues collected from the Sale of the State's Share of production in onshore blocks amount to MMK 30,826 million which represents 1.3% of the total Oil and Gas revenues in FY 2014-2015; and
- the revenues collected from the royalties amount to MMK 393,051 million which represents 16% of the total Oil and Gas revenues in FY 2014-2015.

Gems and jade

According to data reported by MGE, 11,039,786 carats, 8.8 tons of gems and 16,892 tons of Jade were produced in 2014-2015 as follows:

Table 7: Production Gems and Jade in FY 2014-2015

	Region	Sharing / Private		Production	Unit	Value (in million MMK) ¹⁷	
Gems	Mogoke	Joint Venture	Ruby & Sapphire	1,027,960	Carat	83.37	
			Assorted Color Gem	35	Kg	1.80	
		Private	Ruby & Sapphire	7,424,691	Carat	669.28	
			Assorted Color Gem	8,797	Kg	110.26	
	Mong Hsu	Joint Venture	Ruby & Sapphire	53,300	Carat	2.62	
		Private	Ruby & Sapphire	2,533,835	Carat	118.81	
Total Gems						986.13	
Jade	Kachin State	Joint Venture	Jade	4,404,474	Kg	10,598.33	
			Quartzite & Amber	205,511	Kg		
		Private	Jade	11,244,387	Kg		25,148.14
			Quartzite & Amber	315,026	Kg		
	Sagaing Region	Private	Jade	691,219	Kg		
			Quartzite & Amber	32,262	Kg		
Total Jade						35,746.46	
Total						36,732.59	

1,667,416 carats and 433.2 Kg of gems and 9,575 tons of Jade were sold in the two-emporium organised during the 2014-2015 fiscal year. The value of Gems and Jade sold during the two emporiums was MMK 1,137,231 million (US\$ 1,142.65 million).

The volume and value of sales were reported by MGE based on the basis of the emporium data only.

Table 8: Emporium sales of Gems and Jade

	JV/Private	Volume		Sale Price	Volume		Sale Price	Total (in million MMK)
		Carat	Kg	EUR	Carat	Kg	(in million MMK)	
Gems	Joint Venture	659,977	22.82	3,852,840	419,683	0	791,382,400	5,645.31
	Private	542,110	290.91	3,212,026	45,647	119.47	1,168,655,905	5,215.27
Jade	Joint Venture		617,970	252,648,050		3,161,431	23,211,432,570.00	341,505.46
	Private		2,112,545	547,841,700		3,683,923	94,677,049,861	784,865.39
Total								1,137,231.43

¹⁷ The value of Gems and Jade is on the basis of the valuation made by the valuation committees. This value is used for the determination of the royalties on production

According to the Central Statistical Organisation (CSO), the total Gems and Jade exports amount to US\$ 1,027.15 million in FY 2014-2015.

The detail of Gems and Jade production and Emporium sales is presented in the Appendix 6 of the report.

We understand that MGE collection its share from the emporium Joint Venture sales in cash. According to MGE reporting templates, the revenues collected from the Sale of the MGE's Share in Joint Ventures (Sale Split) amount to MMK 115,229 million which represents 29.7% of the total Gems and Jade revenues in FY 2014-2015.

According to the data provided by MGE, 31,728 kg of Jade were collected by MGE from the Gems and Jade companies in FY 2015-2016. We understand that revenues collected in-kind by MGE are maintained in the museum and not sold. Therefore, no revenues from the sale of this jade are received by MGE in FY 2014-2015.

Other minerals

The production and exports/sale value for other minerals as declared by SOE's, amounted to MMK 478,293 million and MMK 193,599 million, respectively. The table below shows the contribution of each category of minerals in relation to total production and exports of the other minerals sub-sector:

Table 9: Production and export of other minerals

Minerals	Production value (in million MMK)	in %	Export (in million MMK)	in %
Lead, Zinc, Copper, Iron, Chromium and Antimony (reported by ME 1)	7,505	2%	164,897	85%
Gold, Tin and Refined Tin (reported by ME 2)	67,129	14%	5,172	3%
Coal, Manganese, Nickel, Barite, Limestone, Gypsum (reported by ME 3)	403,659	84%	23,530	12%
Total	478,293	100%	193,599	100%

The breakdown by mineral of the volume and value of production and exports is presented in the Appendix 6 of the report.

According to the other minerals SOEs reporting templates, the in-kind revenues collected from the Sale of the State's Share of production (Production Split) are as follows:

Table 10: In-kind revenues from State's Share of production 2014-2015

Commodity	Quantity	Unit	Value (in million MMK)
Tin	201.69	MT	1,519.18
Tungsten	1.56	MT	24.72
Tin/Tungsten Mixed	163.38	MT	1,467.85
Tin/Tungsten /Scheelite Mixed	201.42	MT	1,828.34
Gold	12,880.27	ToZ	16,245.89
Total			21,086.01

The revenues collected from the Sale of the other minerals SOE's Share of production amount to MMK 57,676 million which represents 46.2% of the total other minerals revenues in FY 2014-2015.

Pearls

The volume and value of sales were reported by MPE based on the basis of the emporium data:

Table 11: Emporium sales of Pearls

No.	Date	Name of Emporium	Pair	Number of Pearls	Weight (Mome)	Sale Price		Total (in million MMK)
						EUR	USD	
1	24.6.2014 to 27.6.2014	51th EMPO	202	122,518	60,121	3,071,002	0	3,869
2	25.2.2015 to 27.2.2015	3rd MPA (HK)	277	78,784	49,711		10,187,741	10,139
Total			479	201,302	109,831	3,071,002	10,187,741	14,008

1.3. Scope of the data collection and reconciliation

Payment flows and data reported

MSG agreed that for the purpose of MEITI Report the revenues collected from the extractive sector in Myanmar for the fiscal year 2014-2015 would comprise the following sectors:

- Oil and Gas including their transportation; and
- Mining (including jade and gemstones, other minerals and pearl sectors).

The scope of revenue streams included for reconciliation include:

- all tax payments, non-tax payments and in-kind payments made or reported by companies selected in the scope and revenues received by or reported to the Government Agencies during the fiscal year 2015-2016; and
- all transfers made or reported to SOEs and revenues received by or reported to Government Agencies during the fiscal year 2014-2015.

Payments made by companies not selected in the scope, social payments and cash flows from the sale of the State's production share are disclosed unilaterally but not are not part of the reconciliation process in this report.

Extractive companies

For Mining sector, MSG identified 101 companies to be included in the reconciliation process for the second MEITI Report. The companies listed in Section 4.2.2 meet the materiality threshold of **MMK 0.75 billion** for Gems and Jade sector and **MMK 0.25 billion** for other minerals.

With regards to the Oil and Gas sector, MSG has agreed to include all Oil and Gas operators in producing field and exploration companies without applying any materiality threshold. This has led to the selection of 36 Oil and Gas companies and 5 transportation companies within the reconciliation scope. These companies are listed in Section 4.2.1 of the report.

Details of number of companies included within the 2014-2015 scope are set out in the table below:

Table 12: Actual coverage by sub-sector

EITI Scope	Coverage		
	Oil and Gas	Gems and Jade	Mining
Number of companies selected	41	72	29
Materiality	All companies	MMK 0.74 billion	MMK 0.25 billion
Actual coverage by sub sector ¹⁸	100%	57%	72%
Actual overall reconciliation coverage ¹⁹		94%	

¹⁸ The % of coverage is calculated on the basis of reconciled revenues / Total revenues excluding the social payments and revenues from the sale of State's share of production

¹⁹ Ibid

Government Agencies

MSG determined that all Government Agencies which receive extractive-related revenues from companies are included within the reconciliation scope. Accordingly, MSG identified fifteen (15) Government Agencies to be included as listed in Section 4.2.3 of the report.

1.4. Comprehensiveness and reliability of data

Data submission

All companies included in the reconciliation scope have submitted their reporting templates according to the reporting instructions approved by the MSG, with the exception of:

- Height (8) Oil and Gas companies (Nippon Oil, Jubilant Oil and Gas Pte.Ltd, Asia Orient International Ltd, Petrovietnam Exploration Production Corporation, Oil India Ltd, CFG Energy Pte.Ltd, Reliance Industries Ltd and Tap Energy Pte. Ltd). According to the data submitted by Government Agencies, there were no payments made by these companies except for Nippon Oil for which IRD has reported CIT amounting to MMK 11,938,845,668.
- One (1) Oil and Gas transportation company (South East Asia Crude Oil Pipeline Co, Ltd (SEACOP)). According to the data submitted by Government Agencies, there were no payments made by this company.

Furthermore, we received an official letter from MOGE confirming that no other payments were received from these companies during the 2014-2015 financial year. In the official MOGE explained in the official letter that:

- SEACOP did not start its operation yet in FY 2014-2015 and therefore no payments were received from this company; and
- the eight (8) Oil and Gas companies (Nippon Oil, Jubilant Oil and Gas Pte.Ltd, Asia Orient International Ltd, Petrovietnam Exploration Production Corporation, Oil India Ltd, CFG Energy Pte.Ltd, Reliance Industries Ltd and Tap Energy Pte. Ltd) were in study period during FY 2014-2015 (except Jubilant Oil which were in exploration phase) and did not continue the operations in Myanmar. These companies are already relinquished or in termination process. Therefore, it was impossible to obtain the reporting templates from them. The situation of the 8 Oil and Gas companies that did not submit Reporting Templates, according to the official letter obtained for MOGE, is presented in the Appendix 19 of the report.

All Government Agencies included in the reconciliation scope submitted their reporting templates according to the reporting instructions approved by MSG.

Reliability of data submitted

Selected companies

As decided by MSG, the reporting templates should be approved by an authorised company official.

According, all companies have submitted reporting templates signed by an authorised officer as requested by the MSG, with the exception of:

- "Gail JJ India Ltd" which submitted a nil-declaration. According to the official letter received from MOGE, Gail JJ India Ltd is partner in Shwe project and has 5 years tax exemption according to Myanmar Investment Commission (MIC) law.; and
- One (1) other minerals company (BAGAN BUSINESS GROUP). The total payments declared by the Government Agencies and SOEs as received from this company represents 0.11% of the other minerals sector payments.

Government Agencies

With regards to Government Agencies including SOEs, reporting templates should be signed by an authorised officer and certified by the Office of Auditor General (OAG).

This has been complied with by all SOEs and Government Agencies selected within the reconciliation scope.

All reporting templates and audit reports for the FY 2014-2015 are presented in Appendix 14 of the report.

Summary

The Independent Administrator does not audit the figures presented and relies on assurance from reporting entities.

91% of the companies (in number) that submitted reporting templates gave a management assurance letter or have confirmed that their financial statements for the fiscal year 2014/15 have been audited. The payments reported by the Government Agencies and SOEs for these companies represents 99.9% of the total payments made by the companies included in the reconciliation scope.

Based on the MSG agreed assurance procedures, we conducted the Final Assessment of Assurance after the reconciliation of the financial data. For companies, 99.97% of the total revenues reconciled was assessed within high range, 0.03% of the total revenues reconciled was assessed within medium range and only 0% of the total revenues reconciled was assessed within low range.

For Government Agencies and SOEs, although the majority of the entities remained within low to medium range, due to reconciliation process between payment amounts by companies and SOEs and received amounts by government entities, when data assurance of the companies and SOEs increased, by principle, data assurance of the government increased. Therefore, the IA concluded that the final assessment of the overall comprehensiveness and reliability of reconciled financial data from the companies, SOEs and government entities to be satisfactory. However, there remains room for significant improvement to improve the level of assurance generally on SOEs figures, and for the current report, there are some gaps between the EITI figures and SOEs accounts figures (see Sections 1.5 and 5.7.1).

There remains room for significant improvement to improve the level of assurance in general on company figures, and for the current report, there are some gaps in the assurance information provided by the extractive companies.

Management assurances were received from all SOEs and Government Agencies selected in the scope. All oil, gas and mining SOEs selected in the scope were able to submit reporting templates certified by OAG.

1.5. Summary of the reconciliation results

Total revenues received from extractive companies as declared by Government Agencies amounted to MMK 3,363,360 million during the period covered by the report. The table and figure below summarise the reconciled revenues and revenues disclosed unilaterally by the government in accordance with the reconciliation scope.

Table 13: Total payments from the extractive industries which were included in the reconciliation

Figures in million MMK

Sub-sector	Reconciled revenues ²⁰	Unilateral Disclosure	Sales of the State share of production	Social payments	Total revenues
Oil & Gas	2,348,799	-	30,826	4,810	2,384,434
Oil & Gas transportation	493,272	-	-	4,500	497,772
Gems & Jade	218,718	168,293		18	387,029
Other Minerals	66,156	25,436	30,391	2,865	124,848
Pearl	-	102	14,008	-	14,110
Total	3,126,945	193,831	75,225	12,193	3,408,193
%	91.7%	5.7%	2.2%	0.4%	100%

Reconciliation of payments to the Government Agencies

Moore Stephens has been contracted to reconcile taxes reported by extractive companies and Government Agencies in order to identify and clarify any potential discrepancies in the payments reported in the declarations. Disaggregated reporting is detailed in Section 5 of this report.

A net difference of **MMK (87,401) million** (US\$ 87.817 million) representing (2.8%) of Government reporting templates after adjustments remained unreconciled. This is the sum of positive differences of MMK 26,818 million and negative differences amounting to MMK (114,219) million.

²⁰ Source: EITI data reported by Government Agencies after reconciliation adjustments

Table 14: Final discrepancies aggregated compilation

Figures in million MMK

Sub sector	Extractive companies ²¹	Government ²²	Positive difference		Negative difference		Cumulative Difference (Positive Difference + (- Negative Difference))		Net Difference	
			Amount	%	Amount	%	Amount	%	Amount	%
Oil and Gas	2,276,169	2,348,799	5,719	0.2%	(78,349)	(3.3%)	84,068	3.6%	(72,630)	(3.1%)
Gems and Jade	212,095	218,718	9,832	4.5%	(16,455)	(7.5%)	26,287	12.0%	(6,623)	(3.0%)
Other minerals	54,811	66,156	3,393	5.1%	(14,738)	(22.3%)	18,131	27.4%	(11,345)	(17.1%)
Oil and Gas Transportation	496,470	493,272	7,874	1.6%	(4,676)	(0.9%)	12,550	2.5%	3,198	0.7%
Total	3,039,545	3,126,945	26,818	0.9%	(114,218)	(3.7%)	141,036	4.5%	(87,400)	(2.8%)

Excluding data related to entities not subject to EITI reporting

The unreconciled difference of (2.8%) is above the final acceptable discrepancy threshold of 2% of the total revenues declared by the Government Agencies/SOEs set by MSG.

The analysis of the unreconciled difference by sector is as follows:

Oil and Gas sector

The total unreconciled discrepancies amounted to MMK (72,630) million representing (3.1%) of total payments reported by Government Agencies. This is the sum of positive differences of MMK 5,719,0 million and negative differences of MMK (78,349.2) million. These unreconciled differences are summarised below:

Reasons for differences	Amount in million MMK
Cut-off error (a)	(58,875.5)
Reporting template not submitted by the extractive company (b)	(11,938.8)
Tax not reported by the extractive company (c)	(7,956.2)
Tax not reported by the Govt Agency (d)	6,145.7
Sum of not material differences (e)	(5.2)
Total Differences	(72,630.1)

²¹ Source: EITI data reported by Government Agencies after reconciliation adjustments

²² Source: EITI data reported by Government Agencies after reconciliation adjustments

(a) Cut-off errors

This difference is related to the fact that oil and gas companies pay the tax before the end of March and flag receipt are issued in April due to the lengthy process between the transfer date and the date of the receipt. This is explained by the fact that the transfers in USD are made to Myanmar Economic Bank (MEB) and then MOGE receive the equivalent in MMK in its own bank account. Accordingly, Oil and Gas companies reported final tax payments for the year 2013-2014 which were paid in March 2014. However, MOGE reported final tax payment of the year 2014-2015 according to the date of receipt of the transfer from MEB.

Details of this discrepancy by company and by tax are presented in the Section 5.1.3 of the report.

(b) Reporting template not submitted by the extractive company

This difference is related to taxes reported by government entities. However, the companies didn't report these payments in their reporting templates.

Details of this discrepancy by company and by tax are presented in the Section 5.1.3 of the report.

(c) Tax not reported by the extractive company

This difference is mainly related to withholding taxes reported by IRD but not reported by the extractive companies. We understand that the withholding tax reported by IRD is paid by tax agents not selected in the scope. The tax withheld on behalf of the Oil and Gas companies is remitted to the IRD. As these amounts were not directly paid by the companies to IRD, they did not include them in their reporting templates.

(d) Tax not confirmed by the Govt Agency

The difference related to the withholding tax is explained by the fact that this withholding is paid by the companies as tax agent on behalf of their suppliers and sub-contractors. IRD did not maintain in its record the identity of the company that paid this withholding tax and cannot therefore confirm that these amounts were paid by Oil and Gas companies. The payment receipts mention only the name of the supplier or sub-contractor and do not include the name of the company that withheld and paid the tax to IRD.

Gems and Jade

The total unreconciled discrepancies amounted to MMK (6,623.3) representing (3.0%) of total payments reported by Government Agencies. This is the sum of positive differences of MMK 9,832.0 million and negative differences amounting to MMK (16,455.4) million. These unreconciled differences can be analysed as follows:

Reasons for differences	Amount in million MMK
Tax not reported by the extractive company (a)	(20,285.3)
Tax not reported by the Govt Agency (b)	13,664.0
Sum of not material differences (c)	(2.0)
Total Differences	(6,623.3)

(a) Tax not reported by the extractive company

This difference is related to taxes declared by Government Agencies as a payment from Gems and Jade companies. However, the companies didn't report these payments in their reporting templates. This difference represents the final unexplained difference after performance of the reconciliation work and input of the confirmed adjustments.

Details of this discrepancy by company and by tax are presented in the Section 5.2.4 of the report.

(b) Tax not reported by the Government Agency

This difference is related to taxes declared by Gems and Jade companies as a payment to Government Agencies. However, the Government Agencies did not report these payments in their reporting templates. This difference represents the final unexplained difference after performance of the reconciliation work and input of the confirmed adjustments.

Details of this discrepancy by company and by tax are presented in the Section 5.2.4 of the report.

Other minerals

The total unreconciled discrepancies amounted to MMK 11,345.3 million representing (17.15%) of total payments reported by Government Agencies. This is the sum of positive differences of MMK 3,392.6 million and negative differences amounting to MMK (14,738.0) million. These unreconciled differences are summarised in the table below:

Reasons for differences	Amount in million MMK
Tax not reported by the extractive company (a)	(16,725.9)
Tax not reported by the Govt Agency (b)	5,230.9
Missing extractive company detail per receipt number (c)	204.4
Sum of not material differences (c)	(54.8)
Total Differences	(11,345.3)

(a) Tax not reported by the extractive company

This difference is related to taxes declared by Government Agencies as a payment from Other Minerals companies. However, the companies didn't report these payments in their reporting templates. This difference represents the final unexplained difference after performance of the reconciliation work and input of the confirmed adjustments.

Details of this discrepancy by company and by tax are presented in the Section 5.3.3 of the report.

(b) Tax not reported by the Government Agency

This difference is related to taxes declared by Other Minerals companies as a payment to Government Agencies. However, the Government Agencies did not report these payments in their reporting templates. This difference represents the final unexplained difference after performance of the reconciliation work and input of the confirmed adjustments.

Details of this discrepancy by company and by tax are presented in the Section 5.3.3 of the report.

(c) Missing extractive company detail per receipt number

This difference is related to taxes declared by Other Minerals companies as a payment to Government Agencies. However, the companies did not submit the detail per receipt of these amount. Therefore, we were not able to reconcile the amounts with the Government Agencies.

Details of this discrepancy by company and by tax are presented in the Section 5.3.3 of the report.

Oil and Gas Transportation

The total unreconciled discrepancies amounted to MMK 3,198.9 million representing (0.65%) of total payments reported by Government Agencies. This is the sum of positive differences of MMK 7,874.0 million and negative differences of MMK (4,675.9) million. These unreconciled differences are summarised in the table below:

Reasons for differences	Amount in million MMK
Tax not reported by the Govt Agency (a)	7,898.1
Tax not reported by the extractive company (b)	(4,700.0)
Total Differences	3,198.0

(a) Tax not reported by the Government Agency

The difference related to the withholding tax is explained by the fact that this withholding is paid by the companies as tax agent on behalf of their suppliers and sub-contractors. IRD did not maintain in its record the identity of the company that paid this withholding tax and cannot therefore confirm that these amounts were paid by Oil and Gas companies. The payment receipts mention only the name of the supplier or sub-contractor and do not include the name of the company that withheld and paid the tax to IRD.

(b) Tax not reported by the extractive company

This difference is related to taxes declared by Government Agencies as a payment from Other Minerals companies. However, the companies didn't report these payments in their reporting templates. This difference represents the final unexplained difference after performance of the reconciliation work and input of the confirmed adjustments.

Details of this discrepancy by company and by tax are presented in the Section 5.3.3 of the report.

The reconciliation sheets by company are presented in the Appendix 18 of the report.

Detail of reconciliation and adjustments made by company and by tax are set out in the Section 5 of this report.

Reconciliation of payments in kind to Government Agencies

We also reconciled in kind payments made by extractive companies selected in the scope with commodities received by Government Agencies and we note differences as detailed in the table below:

Table 15: In kind payments final discrepancies

Payment in kind	Government Agency	Extractive companies	Government	Differences
Oil and Gas sub-sector				
Payment in kind (Barrels)	MOGE	1,259,501	1,259,501	0
Payment in kind (MMscf)	MOGE	130,283	645	129,638
Gems and Jade sub-sector				
Payment in kind (Kg)	MGE	569,920	31,728	538,192
Mining sub-sector				
Gold in ToZ	ME (2)	14,169	13,134	1,035
Tin in MT	ME (2)	438	471	(33)
Copper in MT	DOM	1,444	1,444	-

Detail of reconciliation and adjustments made by company and by tax are set out in the Section 5 of this report.

Reconciliation of production and exports

We also reconciled the production and exports made by extractive companies selected in the scope with Government Agencies and note the differences as detailed in the table below:

Table 16: Reconciliation of production and exports

Oil and Gas production

Production	Company		MOGE		Difference	
	Oil (Barrels)	Gas (MMscf)	Oil (Barrels)	Gas (MMscf)	Oil (Barrels)	Gas (MMscf)
Offshore Production	3,071,247	642,682	2,869,870	651,584	201,377	(8,901)
Onshore Production	1,744,317	645	1,744,317	645	-	-
Total production	4,815,564	1,287,681	4,614,187	1,296,582	201,377	(8,901)

Oil and Gas exports

Exportation	Company			MOGE			Difference		
	Volumes		Value	Volumes		Value	Volumes		Value
	Oil (Barrels)	Gas (MMscf)	USD	Oil (Barrels)	Gas (MMscf)	USD	Oil (Barrels)	Gas (MMscf)	USD
Exportation	1,393,989	530,312	5,020,806,987	1,376,527	530,469	4,922,564,380	17,462	(157)	98,242,606

Gems and Jade production

Production	Company		MGE		Difference	
	Volume	Unit	Volume	Unit	Volume	Unit
Gems	372,414	CARAT	487,364	CARAT	(114,950)	CARAT
Jade	4,410,348	KG	6,853,332	KG	(2,442,984)	KG

Gems and Jade Emporium sales

Sales	Per company				Per Government				Final difference			
	Sales in Euro		Sales in MMK		Sales in Euro		Sales in MMK		Sales in Euro		Sales in MMK	
	Volume	Value EUR	Volume	Value MMK	Volume	Value EUR	Volume	Value MMK	Volume	Value EUR	Volume	Value MMK
Gems	624,043	6,141,959	-	-	422,441	1,766,453	-	-	201,602	4,375,506	0	0
Jade	980,022	805,155,647	2,347,483	18,930,409,327	786,807	443,913,404	4,080,385	57,749,820,743	193,215	361,242,243	(1,732,902)	(38,819,411,416)

Other minerals production

Type of mineral produced	Company		MONREC		Difference
	Volume	Unit	Volume	Unit	
Ferro Nickel	20,993	MT	90,620	MT	(69,628)
Gypsum	10,000	MT	18,300	MT	(8,300)
Gold	384	Tical	-	-	384
Antimony	4,895	MT	8,277	MT	(3,382)
Coal	18,578	MT	207,022	MT	(188,444)
Line Stone	-	-	437,790	MT	(437,790)
Bauxite	-	-	3,750	MT	(3,750)
Lead	904	MT	1,474	MT	(570)
Zinc	383	MT	382	MT	1
Lead concentrate	3,750	MT	3,750	MT	-
Cathode Copper	32,401	MT	36,003	MT	(3,602)
Copper	-	-	1,495	MT	(1,495)
Tin & Tungsten	956	MT	-	-	956

Other minerals exports

Type of mineral	Company				MONREC				Differences	
	Volume	Unit	Value	Currency	Volume	Unit	Value	Currency	Volume	Value
Nickel	20,993	MT	242,297,076	USD	90,662	MT	23,642,309	USD	(69,669)	218,654,766
Antimony	600	MT	3,417,779	USD	6,732	MT	1,542,100	USD	(6,132)	1,875,679
Lead	1,806	MT	1,518,742	USD					1,806	1,518,742
Zinc	754	MT	278,763	USD					754	278,763
Antimony Ore	800	MT	1,069,000	USD	800	MT	1,033,200	USD	-	35,800
Lead concentrate	4,000	MT	2,595,880	USD	4,000	MT	2,595,880	USD	-	-
Cathode Copper	23,125	MT	156,440,718	USD	30,125	MT	156,440,000	USD	(7,000)	718
Copper					500	MT	207,000	USD	(500)	(207,000)
Tin & Tungsten	361	MT	65,381,185	MMK						65,381,185
			2,174,521	USD					361	2,174,521
			1,061,697	EUR						1,061,697

Detail of reconciliation and adjustments made by company and by tax are set out in the Section 5 of this report.

Reconciliation of transfers made by SOEs to MOPF

According to MSG's decision, transfers made by SOEs to MoPF and other Government Agencies such as DoM, IRD and Customs department were also reconciled.

A difference of MMK 772 million between transfers to OA reported by SOEs and transfers reported by Government Agencies remains unreconciled. Details by SOE are set out in the table below:

Table 17: reconciliation results of transfers made by SOE's

Figures in million MMK

SOE	SOE		Government Agency		Final difference	
	Transfers to MoPF and DoM	Other accounts - SOE own Accounts	Transfers to MoPF and DoM	Other accounts - SOE own Accounts	Transfers to MoPF and DoM	Other accounts - SOE own Accounts
MOGE	1,031,993	1,179,203	1,031,993	1,179,246	-	(43)
MGE	137,236	112,394	137,236	113,007	-	(613)
ME (1)	4,021	4,365	4,021	4,365	-	0
ME (2)	14,180	22,319	14,180	22,319	-	0
ME (3)	1,627	27,534	1,627	27,650	-	(116)
Total	1,189,057	1,345,815	1,189,057	1,346,587	-	(772)

Individual tax templates by SOE showing the reconciliation work are set out in Appendix 8 of this report.

1.6. Findings and recommendations

We raised several findings and have made recommendations with a view to improve the EITI process in Myanmar and governance of the extractive sector and revenue management. The findings raised are summarised as follows:

Findings	
Governance of the extractive revenues	
1	Strengthen the institutional capacities of the IRD
2	Lack of unique Taxpayer Identification Number (TIN) used by all Government Agencies for the identification of the extractive companies
3	Consider setting a resource revenue sharing system for extractive revenues
4	Lack of transparency of SOEs
Management of the Gems and Jade sector	
5	Lack of certification, traceability and valuation of the gemstones
6	Gemstones sector institutional reform
EITI implementation	
7	Completeness of the data reported on license register
8	Unclear licensing process
9	Lack of availability and accessibility of information -IRD
10	Delayed submission of templates
11	Improvement in the bidding process for O&G blocks
12	Improvement in the bidding process for gemstone permits
13	Creation of a reporting system for employment data
14	Inaccuracy of production data
15	Lack of availability and accessibility of information on companies social and environmental commitments
16	Improving the implementation of projects donated by extractive companies
17	Lack of reporting at project level
18	Extracting Data and Information
19	MSG to consider expanding scope of participating companies
20	Sale of the State' share of production
21	Implementation of recommendations from the first MEITI report

These findings and the associated recommendations are detailed in Section 7 of this report.

Tim Woodward
Partner
Moore Stephens LLP
26 March 2018

150 Aldersgate Street
London EC1A 4AB

2. APPROACH AND METHODOLOGY

The reconciliation of revenues from the extractive sector consisted of the following steps:

- conduct a scoping study to determine the scope of the reconciliation exercise and to design the reporting;
- preparation of a reporting template (See Appendix 7) and reporting instructions;
- collection of payment and other data from Government Agencies and extractive companies which provide the basis for reconciliation;
- comparison of payments and other data reported by Government Agencies and extractive companies to determine if there are discrepancies between the amounts reported as being received by the authorities and the reported as being paid by taxpayers; and
- contact Government Agencies and extractive companies to investigate and resolve identified discrepancies.

2.1. Scoping Study

The financial flows to be included in the reconciliation, the Government Agencies and companies which were required to report were determined by MSG based on the basis of the scoping study conducted by Moore Stephens.

Under the TOR for the Engagement, we were required to carry out a scoping study which eventually determined the scope of the second MEITI Reports, including a proposal of:

- the materiality threshold for receipts and payments by sub-sector;
- taxes and revenues to be included;
- companies and Government Agencies to be included in the report; and
- assurances to be provided by reporting parties to ensure credibility of the data being reported.

The scope of the EITI report as decided by MSG during their meeting of 2 October 2017 is described in Section 4 of the report.

2.2. Data collection

A standard reporting template and instructions were designed to facilitate the process for the reporting entities. The template was designed to include the revenue streams paid to each Government Entity and was formatted in such a way that companies could easily identify and determine the appropriate amounts to be disclosed. The reporting templates were sent electronically to the reporting entities.

The companies and Government Agencies were required to report directly to the Reconciler and they were also requested to whom they were instructed to direct any questions on the reporting templates.

Companies and Government Agencies were requested to submit a breakdown of payments by date and by receipt in the supporting schedules.

MSG agreed that the deadline for submission of the reporting templates would be 27 October 2017 for the soft copies and 10 November 2017 for the signed hard copies.

2.3. Reconciliation and investigation of discrepancies

The data reconciling exercise was carried out between 6 November and 22 December 2017. In carrying out the reconciliation, we performed the following procedures:

Initial Reconciliation Procedures: Figures reported by extractive companies were compiled item by item and compared with figures reported by Government Agencies. As a result, all discrepancies identified have been listed by item in relation to each Government Agency and company.

In cases where the reported revenue data from Governmental Agencies agreed with a company's reported payment data, with deviation within the allowable variance as described in section below, the government figures were considered to be confirmed and no further action was undertaken.

In cases where the reported revenue data from Governmental Agencies did not agree with a company's reported payment data and the difference was not within the allowable variance, discrepancies were identified for each company and Government Entity and the discrepancies were subject to further investigations before completing the initial reconciliation report.

Reconciliation Variance and Level of Effort: As part of the reporting template finalisation, a variance threshold of MMK 5 million was set to help determine an acceptable level of effort to be spent in attempting to resolve discrepancies.

In cases where the reported revenue data from government Agencies did not agree with the company's reported payment data, and the discrepancies were at or below the variance threshold, the Reconciler concluded that the discrepancies were not material to the MEITI Report.

Follow-Up Procedures to Investigate Differences: In cases where the reported revenue data from Governmental Agencies did not agree with the company's reported payments and the discrepancies were outside the variance, the IA considered the discrepancies to be material and further investigations were performed in a bid to resolve these discrepancies. In such instances, the Government Agencies and companies were requested to provide supporting documents and/or confirmations in respect of any adjustments to the data provided in the original reporting templates.

We contacted the reporting entities and arranged meetings with relevant officials. We also reviewed additional supporting documentation evidencing the payments reported. In instances where we were unable to identify the reason for the discrepancies following the review of additional supporting evidence, we concluded that the discrepancies were "undetermined / unexplained". The results of our work are presented in Section 5 of the report. Adjustments made to reporting templates are presented in Appendices 3 to 5.

2.4. Reliability and credibility of data reported

Initial assessment of assurance procedure

The EITI Standard requires that a credible assurance process applying international standards should be in place. The approach adopted for the 2015-16 MEITI Report incorporated constraints existing in Myanmar and insufficiencies noticed during the previous reconciliation.

Moore Stephens applied its professional judgement to assess the extent to which reliance can be placed on the existing controls and audit framework (ECAF) of the companies, SOEs and government entities. This step helps in determining the initial assessment of assurance (IAA) for each of the reporting. In short, when the AF is rated low, the IAA is rated low (i.e. low assurance).

The assessment is based on the key factors such as accounting standards applied (international standards, local reliable standards, other standards), existing governance and internal controls, audit standards applied where the entities are audited, and the reliability of the auditor where an auditor exists.

In order to comply with EITI Requirement 4.9 of the EITI Standard (2016) which aims to guarantee the credibility of the data submitted by reporting entities, MSG agreed the following approach for the preparation of the 2014-2015 MEITI report:

For extractive companies

The classification was made based on the accounting standards applied (see section 3.8.1), audit standards applied where the companies are audited. The ECAF and the IAA for the extractive companies were considered low for mining companies and medium for Oil and Gas companies.

The companies selected in the scope where requested to submit their reporting templates:

- signed by a person authorised to represent the extractive company (Chief Financial Officer or Chief Executive Officer/Director); and

- supported by details of payments reported.

All selected companies having their accounts audited were also requested to provide a copy of their audited financial statements.

The IA proposed the option of having external auditors signing-off on the data submitted by the companies selected in the scope. The companies explained that they had no budget available to pay for such attestation reports and the time constraint would not allow reliable audit firms to perform the necessary assurance procedures.

Government Agencies and SOEs

Usually, in most developing countries central government agencies and SOEs are in a low range of the rating for the ECAF and thus for the IAA. Moore Stephens and the MSG considered the reconciliation findings as well as the identified weaknesses in SOEs governance raised in the first MEITI Report and concluded that this would be consistent with low ECAF.

Based on the above, Moore Stephens and the MSG agreed that for the 2015-16 that all Government Agencies and SOEs selected in the scope should submit a reporting template:

- signed by a person authorised to represent the Government Agency;
- accompanied by payment details reported; and
- certified by the Office of the Auditor General.

Final assessment of assurance procedure

Moore Stephens analysed the data received from government agencies and from companies as described in the section above and applied the following criteria for assurance:

- Non-submission of a reporting template signed by a person authorized to represent the Government Agency, the SOE or the company reduced the level of assurance;
- Non-submission of payment details for the amounts reported also reduced the level of assurance; and
- Absence of audit reports or reporting reduced the level of assurance.

Thus, the level of assurance for each selected entity was graded:

- Low level of assurance – entities that are not audited and did not provide representation letters, or entities that are audited and did not provide representation letters or provided incomplete representation letters.
- Medium level of assurance
- High level of assurance – entities that provided representation letters signed by the respective representatives as stated above and provided audit reports.

The assessment of assurance is presented in the table below:

Companies	Number of companies	Total payments (in million MMK)	% based on revenue stream	Assessment
No audit report and no signed hard copy of RT	1	-	-	Low
Provided signed hard copy of RT, but no audit report	11	997	0.03%	Medium
Provided signed hard copy of RT and audit report	119	3,038,548	99.97%	High
Total	131	3,039,545	100%	

Gov Agencies and SOEs	Number of entities	Total revenues	% based on revenue stream	Assessment
No audit report and hard copy of RT	-	-	-	Low
Provided hard copy of RT, but no audit report	-	-	-	Medium
Provided hard copy of RT and audit report	13	3,320,776	100%	High
Total	13	3,320,776	100%	

Conclusion – Assessment of the overall comprehensiveness and reliability of reconciled data

Based on the MSG agreed assurance procedures, we conducted the Final Assessment of Assurance after the reconciliation of the financial data. For companies, 99.97% of the total revenues reconciled was assessed within high range, 0.03% of the total revenues reconciled was assessed within medium range and only 0% of the total revenues reconciled was assessed within low range.

For Government Agencies and SOEs, although the majority of the entities remained within low to medium range, due to reconciliation process between payment amounts by companies and SOEs and received amounts by government entities, when data assurance of the companies and SOEs increased, by principle, data assurance of the government increased. Therefore, the IA concluded that the final assessment of the overall comprehensiveness and reliability of reconciled financial data from the companies, SOEs and government entities to be satisfactory. However, there remains room for significant improvement to improve the level of assurance generally on SOEs figures, and for the current report, there are some gaps between the EITI figures and SOEs accounts figures (see Sections 1.5 and 5.7.1).

2.5. Basis and period of reporting

In order to comply with Requirement 2 of the EITI Standard, the MSG agreed that the 2014/15 MEITI Report would be based on data for the fiscal year 2014-2015.

MSG defined the reporting period as the Fiscal Year (FY). For the 2014/15 MEITI Report, the reconciliation has been carried out on data for FY 2014-2015, which is 1 April 2014 through 31 March 2015.

The revenue streams included in the reconciliation scope relate to only the payments made by companies and revenues received by Government Agencies during FY 2014-2015. The period in which the fees are incurred by companies is not relevant; only the period in which the fees were paid and reported is relevant.

The reporting currency is MMK. For payments made in foreign currency, the reporting entities were required to report in the currency of payment. Payments made in foreign currency (US\$ and Euro) have been converted to MMK at the actual rate used by the Government Agency to record the amount received.

Where actual rates were not available or not disclosed by the reporting entities, we applied the average rate for the period as published by the Central Bank of Myanmar. The average rate used were as follows:

- US\$ 1 = MMK 995.26
- EUR 1= MMK 1,259.83

2.6. Procedures for the management and protection of the collected data

In order to protect the confidentiality of the data collected from the reporting entities, the following measures have been applied:

- only the data required by the EITI Standard, Terms of Reference and reconciliation exercise has been requested. Any irrelevant information inadvertently communicated has been deleted and/or destroyed;
- data collected is processed on password-protected laptops and e-mail communications are performed via secure messaging servers;
- reporting entities were requested to address the completed reporting template and any information considered sensitive or confidential directly to the IA's generic email address: (meiti@moorestephens.com)
- all requests for additional information from Government Agencies or extractive companies for the reconciliation purposes were processed in accordance with the above protocol.

3. CONTEXTUAL INFORMATION ON THE EXTRACTIVE INDUSTRY

3.1. Extractive sector in Myanmar

Myanmar's natural resources include oil and gas, minerals and gems. The extractive sector accounted for 6% of GDP, 23.6% of State revenue and 38.5% of exports in 2013²³. It has proven oil reserves of 50 million barrels and proven gas reserves of 10 trillion cubic feet and it is one of the largest producers and exporters of Jade in the world.

The extractive sector is the second largest source of foreign direct investment and represent close to 40% of the country's exports, with gas and gems being the two-main revenue generating commodities.

In 2014-2015, Myanmar produced a variety of extractive commodities, including natural gas, petroleum, coal, copper, precious and semi-precious stones, tin, tungsten, and zinc.

According to the Central Statistical Organisation, gas accounted for 41% of exports and Gems and Jade accounted for 8% of exports in FY 2014-2015. The Central Statistical Organisation reported total sales of gas amounting to US \$5.1 billion in FY 2014-2015, up from US \$3.8 billion in FY 2013-2014.

The sectors covered by this report are:

- oil and gas exploration, development, procession and export;
- oil and gas transit and transfer pipelines;
- gemstone sector;
- pearl sector; and
- solid minerals and mining sector.

²³ Source: Myanmar EITI Report 2013-2014

Graphic 5: Overview of major oil, gas and mineral projects in Myanmar

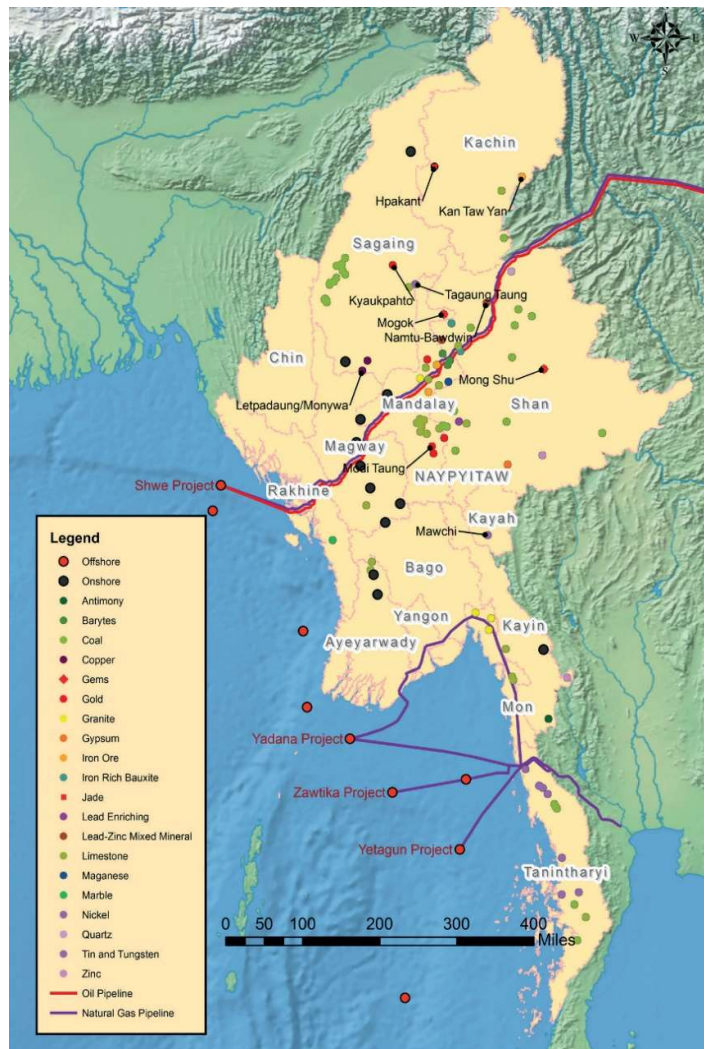

3.2. Oil and Gas sector

3.2.1 General context of the hydrocarbons sector

Myanmar is one of the world's oldest oil producers as its first exports of oil date back to 1853. Myanmar is the second-largest natural gas producer within South East Asia and, over the last decade, its production has increased substantially. According to MOGE, the total gas production in FY 2014-2015 was 652,228 MMscf. The production of condensate and oil amount to 2.8 million barrels and 1.7 million barrels respectively in FY 2014-2015.

According to DICA, Myanmar has received more than US\$69 billion in cumulative foreign direct investment (FDI) as at January 2017. The oil and gas sector attracted over US\$22.4 billion in FDI which represents approximately 32% of the total FDI from 154 foreign enterprises. This makes the country's oil and gas sector one of the top FDI sectors, followed by power, manufacturing, transport and communication²⁴.

Myanmar is open to international exploration, with major international oil companies making significant investments using updated technology to locate new sources. With economic reforms and loosening of international sanctions, the Government of Myanmar has sped up oil and gas exploration and promoted foreign direct investment in the Oil and Gas (O&G) Sector. According to MOGE, Myanmar has not reached its full oil and gas potential. It has estimated proven gas reserves of 9 TCF and proven oil reserves around 138 million barrels from onshore and offshore fields while IHS Global Insights estimates that Myanmar possesses 18 TCF of natural gas reserves and 3.2 billion barrels of oil reserves²⁵.

While much of the activity is taking place offshore, there are at least 49 onshore blocks in different phases of auction, exploration or production. On-shore oil and gas companies are active in nearly every state, especially Bago and Magway. They are noticeably less active in Chin, Shan, Kachin and Tanintharyi.

At 31 March 2016, there were 29 onshore blocks and 38 offshore blocks in exploration and production. The offshore Yadana (TOTAL, Chevron and PTTEP) and Yetagon (Petronas, PTTEP) natural gas projects started production in 1998 and 2000 respectively under gas sales contracts to the Thai state oil company, PTT. The Daewoo (Daewoo and three partners) natural gas project (also known as "Shwe Gas Project") started production in 2013. Natural gas produced is sold to China National Petroleum Corporation. The offshore Zawtika (PTTEP) natural gas project which started production in March 2014 includes a new 300 km long pipeline (270 km of which will be offshore and only 30 km onshore).

The daily production rate of the Yadana natural gas project is 910 million cubic feet (Mcf); Shwe produces around 500 Mcf; Zawtika produces 360 Mcf; and Yetagon produces over 250 Mcf. There are six deep rigs, nine medium rigs and eleven shallow rigs. The total length of natural gas pipeline in the country is 2,200 miles².

The total domestic gas pipeline network ranges from 4 to 20 inches in diameter and spans 2,874km. The domestic pipeline from Yadana to Yangon is 24 inches in diameter and 436 km long. The export pipelines from each of the natural gas fields vary in lengths and diameters: Yadana Pipeline (36 inches, 410km), Yatgun Pipeline (24 inches, 274km), Myanmar China Gas Pipeline (40 inches, 782km in Myanmar) and Zawtika Pipeline (28 inches, 300km). Access to the gas pipeline requires contracting with MOGE.

²⁴ Source: website export.gov: <https://www.export.gov/article?id=Burma-energy-oil-and-gas>

²⁵ Source: NRGi – Country Strategy Note – June 2016

3.2.2 Legal Framework

Upstream activities (exploration and production) in the oil and gas sector are governed by the following legislations:

- the Oil-Fields Act [1918]²⁶;
- the Oil-Fields Rules [1936];
- the Petroleum Act [1934]²⁷;
- the Petroleum Rules [1937]²⁸;
- the Essential Supplies and Services Law 2012²⁹;
- the Oil-fields (Labour and Welfare Act) [1951];
- the Petroleum Resources (Development Regulation Act) [1957];
- the Law Amending the Petroleum Resources (Development Regulation Act) [1969]
- the Myanmar Petroleum Concession Rules [1962];
- the National Environmental Quality Emission Guideline 2015³⁰; and
- the Environmental Impact Assessment Regulations 2015³¹.

Although the terms and conditions of production sharing contracts (PSCs) largely govern exploration and production (E&P) operations, the above-mentioned Oil fields (Labour and Welfare) Act 1951 is of continuing importance to contractors and their service companies. Environmental regulations have become part of the legal framework regulating oil activities.

Of equal importance in the oil and gas sector are the State-Owned Economic Enterprises Law (under which the Myanmar Oil and Gas Enterprise (MOGE) is assigned responsibility for the E&P sector under PSCs with private companies), the Myanmar Investment Law (2016) (MIL) (formerly the Foreign Investment Law (2012) (FIL), repealed by MIL), Myanmar Investment Rules and MIC Notification (under which permits are granted by the Myanmar Investment Commission (MIC) to approve terms and conditions of draft PSCs).

The old petroleum laws refer mainly to rights characterised as concessions. Although the above-mentioned laws relating to petroleum are still applicable, in practice investors generally enter into PSCs, performance compensation contracts (PCCs), improvement of marginal recovery agreements (IPRs), and reactivation agreements. We understand that, the terms and conditions of these contracts govern the process as long as they are not contrary to the laws in force.

²⁶ http://www.myanmarconstitutionaltribunal.org.mm/lawdatabase/sites/default/files/myanmar_code/2016/04/1-1918%20The%20Oilfields%20Act.pdf

²⁷ <https://www.resourcedata.org/document/rgi-petroleum-act-1934->

²⁸ <http://www.explosives.gov.bd/pdf/petroleumrules1937.pdf>

²⁹

http://www.commerce.gov.mm/sites/default/files/documents/2014/12/The%20Essential%20Supplies%20And%20Services%20Law%20_English_final.pdf

³⁰ <http://www.gms->

[eoc.org/uploads/resources/893/attachment/Myanmar%20Environmental%20Quality%20%28Emission%29%20Guidelines_Unofficial_English.pdf](http://www.gms-eoc.org/uploads/resources/893/attachment/Myanmar%20Environmental%20Quality%20%28Emission%29%20Guidelines_Unofficial_English.pdf)

³¹ <http://www.myanmar-responsiblebusiness.org/resources/environmental-impact-assessment-procedures.html>

3.2.3 Institutional framework

The Organisation Chart of the Ministry of Energy during the fiscal year 2014-2015 was as follows:

Graphic 6: Ministry of Energy Organisation Chart

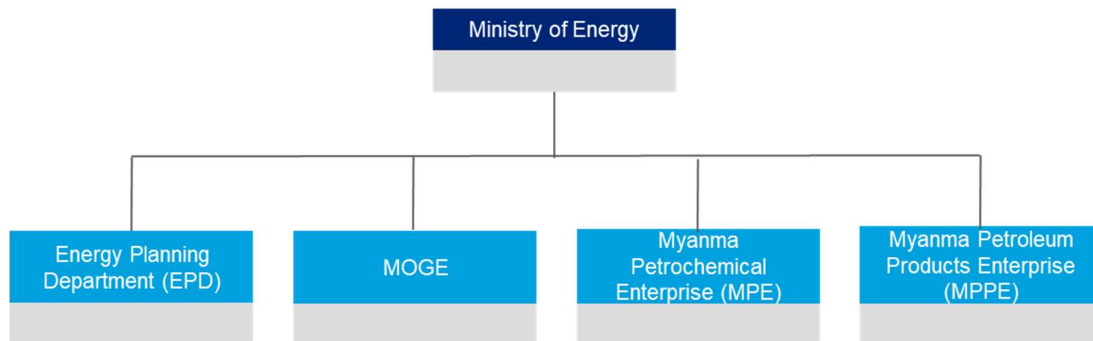

Following the reorganisation of Government ministries announced in March 2016, the Ministry of Electric Power (MOEP) and the Ministry of Energy (MOE) merged to create one of the most powerful and influential economic ministries, the Ministry of Electricity and Energy (MoEE). In the past, MOEP and MOE encountered challenges working on projects together, for example, when it came to supply of gas for new power plants. The combined ministry has the potential to significantly streamline this process.

Graphic 7: MoEE Organisation Chart

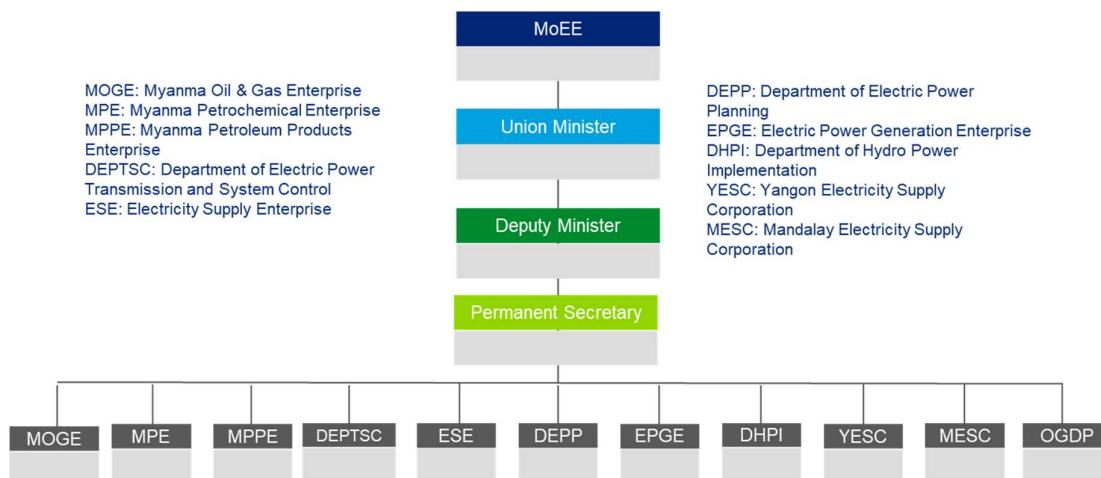

MoEE is the primary Government Agency responsible for the oil and gas sector. Entities within the MoEE that are influential in energy projects are:

- the Oil and Gas Planning Department (OGPD) (formerly Energy Planning Department), which is responsible for energy policy formulation, coordination and the discussion of Energy Development Programme. OGPD is also responsible with MOGE for tendering oil and gas blocks (onshore, shallow water offshore, deep water offshore) in Myanmar and managing concession contracts, exploration and production and sale of oil and gas; and
- MOGE (a 100% State Owned Enterprise), which is responsible for E&P of petroleum within Myanmar, and has exclusive rights to carry out all oil and gas operations with private contractors. MOGE is also responsible for issuing tenders to foreign companies, MOGE is both a regulator and operator.

MoEE has also oversight of two other State Owned Enterprises working in the downstream:

- **Myanmar Petrochemical Enterprise (MPE):** has the oversight of three refineries, five urea fertilizer plants and a number of other processing plants;

- **Myanmar Petroleum Products Enterprise (MPPE):** manages retail and wholesale distribution of petroleum products;
- **Electricity Supply Enterprise (ESE):** distributes power, including off-grid generation and distribution, and implements and operates mini hydropower and diesel stations;
- **Electric Power Generation Enterprise (EPGE):** purchases electricity and distributes it to consumers in Myanmar;
- **Yangon Electricity Supply Corporation (YESC):** manages the supply of Energy in Yangon; and
- **Mandalay Electricity Supply Corporation (MESOC):** manages the supply of Energy in Mandalay.

In order to ensure the development of energy and electrical sectors, the National Energy Management Committee was set up in January 2013 by the President's office notification No (12/2013). It is chaired by the Minister of Energy and comprises MOGE, the Ministry of Energy and the 10 other government institutions involved in energy development and aims to streamline the country's national energy policy.

3.2.4 Main Oil and Gas projects

Badamayar gas project

Total SA has started production from the offshore Badamayar project in May 2017, 220 km South of Yangon in Myanmar. The project will allow an extension of Yadana gas field's 8 billion cu m/year production plateau beyond 2020.

The Badamayar project involves the installation of a new wellhead platform connected to the Yadana production facilities and the drilling of four horizontal wells to develop the Badamayar gas field as a satellite of Yadana. The project also includes a new compression platform.

Total is the operator of the project with a 31.2% interest. Its partners are Chevron-Unocal 28.3%, PTTEP 25.5%, and MOGE 15%³².

Yadana project³³

Total signed the Yadana production sharing contract with MOGE in July 1992 and operates the field with a 31.2% interest with the State-Owned Myanmar Oil and Gas Enterprise (MOGE) holding 15% interest.

The Yadana gas field is located in the Andaman Sea, approximately 60 kilometres offshore the nearest landfall in Myanmar. This major energy resource contains more than 5.3 trillion cubic feet (150 billion cubic metres) of natural gas, with an expected field life of 30 years. Commercial production began in the year 2000 and production averaged more than 21.5 million cubic metres per day in 2007.

The gas is supplied to Thai power plants and is also sold on Myanmar's domestic market. The gas is transported onshore via a 346-kilometre subsea pipeline. A 63-kilometer onshore pipeline then takes it to the Thai border.

³² <http://www.ogj.com/articles/2017/05/total-brings-badamayar-gas-project-on-stream-in-myanmar.html>

³³ <http://burma.total.com/myanmar-en/total-in-myanmar-200275.html>

The Yadana field has five different contractual arrangements:

- PSC and Petroleum Production JV with the following participants: Total as operator with 31.24%, Unocal with 28.26%, PTT Exploration and Production Plc (PTTEP) with 25.50% and MOGE with 15.00%;
- an Export Gas Sales Agreement (EGSA) with the above PSC and the Thai gas buyer PTTEP (to be used in Thai power plants);
- an Export Gas Transportation Agreement (EGTA) between Moattama Gas Transportation Company (MGTC) and the above PSC with the same shareholdings;
- a Production Operating Agreement for the above PSC; and
- a Gas Pipeline Operating Agreement (GPOA) where Total is the operator.



Yetagun project³⁴

The Yetagun gas field is an offshore gas field in the Andaman Sea, spanning an area of approximately 24,130 km². Following the Yadana project, the US\$700 million Yetagun ("waterfall") project was the second natural gas offshore project in Myanmar.

The field is estimated to hold three trillion cubic feet of gas and 80 million barrels of condensate in reserves.

Petronas holds a 40.91% interest and operates the field. The other partners working in the field include Myanmar Oil and Gas Enterprise (MOGE, 20.45%), PTTEP International Limited (PTTEPI, 19.32%) and Nippon Oil Exploration (Myanmar) (19.32%).

The Yetagun field was discovered in December 1992. The field development activities started in 1996, construction of the pipeline and associated facilities were carried out in 1998 and 1999 and commercial production started in May 2000. The field is expected to continue production until 2030.

Natural gas produced from the field is supplied to the Petroleum Authority of Thailand (PTT) through the Taninthayi Pipeline operated by Taninthayi Pipeline Company (TPC), whereas the condensate from the field is stored in the Yetagun FSO vessel and sold to both domestic and international customers.

³⁴ <http://www.offshore-technology.com/projects/yetagun-gas-and-condensate-field/>

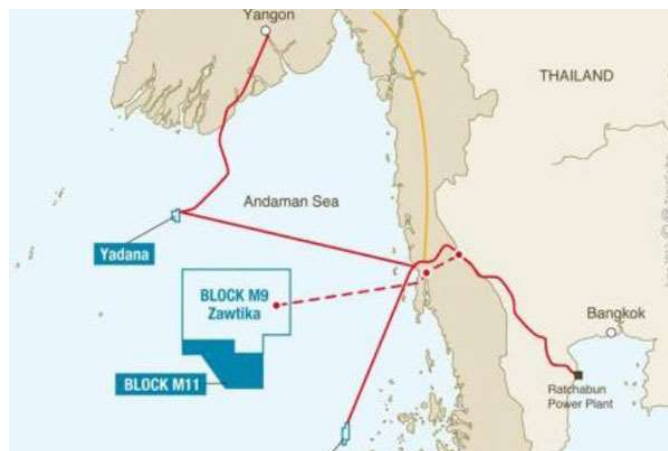

Zawtika project³⁵

The Zawtika project includes the development of the Zawtika, Kakonna and Gawthaka fields, located in blocks M9 and M11 of the Gulf of Martaban, offshore of Myanmar. The project is spread across an area of 11,746 square kilometres.

The Petroleum Authority of Thailand Exploration and Production International (PTTEP International) is the operator of the project. PTTEP owns an 80% interest in the project, with Myanmar Oil and Gas Enterprise (MOGE) holding the remaining 20%.

The USD 2bn project initially started delivering natural gas for domestic purposes in Myanmar in March 2014 at a rate of approximately 60 million standard cubic feet per day (MMscf/d). In August 2014, it started exporting natural gas to Thailand at a rate of 240MMscf/d.

On 5 January 2012, PTTEP Offshore Investment Limited (PTTEPO) with Myanmar Oil and Gas Enterprise (MOGE) entered into a Shareholder Agreement with Andaman Transportation Limited (ATL) to invest in Zawtika gas transportation project. MOGE's investment is under 'the Agreement Establishing the Rights and Obligations of the Andaman Transportation Limited', which stated that, if MOGE exercised its rights to invest 20% of participating interest under the Production Sharing Contract, MOGE would have the rights to invest in the common stock of ATL in the same proportion.³⁶

The offshore Zawtika (PTTEP) natural gas project started production in March 2014.

Shwe Natural Gas Project³⁷

The Shwe Natural Gas project consists of the Shwe, Shwe Phyu and Mya offshore gas fields, located in blocks A-1 and A-3 of the Bay of Bengal, Myanmar.

The project is being developed by a consortium of six companies and led by POSCO subsidiary Daewoo International, which is also the operator of the project.

The first production gas from the Shwe project was achieved in July 2013 from the Mya field and commercial production started in August the same year.

Production from the Shwe gas field started in January 2014, as a result of which, the production by the end of 2014 was expected to reach 500 million cubic feet of gas a day.

This cycle is expected to last until 2020. The gas will either be sold to China National United Oil Corporation (CNUOC) for 25 to 30 years, or used within Myanmar.

In June 2010, MOGE and CNPC created the joint-venture South East Asia Gas Pipeline Co. (SEAGP) to manage the gas pipeline project.

³⁵ <http://www.offshore-technology.com/projects/zawtika-gulf-martaban-myanmar-burma/>

³⁶ www.pttep.com

³⁷ <http://www.offshore-technology.com/projects/shwe-natural-gas-project/>

After three years of construction, the Myanmar-China natural gas pipeline began flowing on 29 July 2013, carrying gas from the Shwe field complex in the Rakhine Offshore Area, Bay of Bengal, to Yunnan province, in South West China. The natural gas is being produced from the Shwe and Shwe Phyu fields in Block A-1 and Mya field in Block A-3. In February 2013, MOGE estimated the gas pipeline cost at USD 2.15 billion.

Chauk and Yenangyaung Fields³⁸

Interraresources holds 60% of the rights and interests to two of the largest onshore oil producing fields in Chauk and Yenangyaung under two Improved Petroleum Recovery Contracts (IPRCs).

The IPRCs with Myanmar Oil and Gas Enterprise (MOGE) commenced on 4 October 1996 for a term of 20 years and 6 months. The two fields are jointly managed through Goldpetrol Joint Operating Company Inc. The adjacent Myanmar concessions extend over a total area of approximately 1,800 square kilometres and are located along the Ayeyarwaddy River, approximately 580 kilometres North of Yangon. In 2014, the combined gross production for both fields was 1,192,523 barrels of oil.

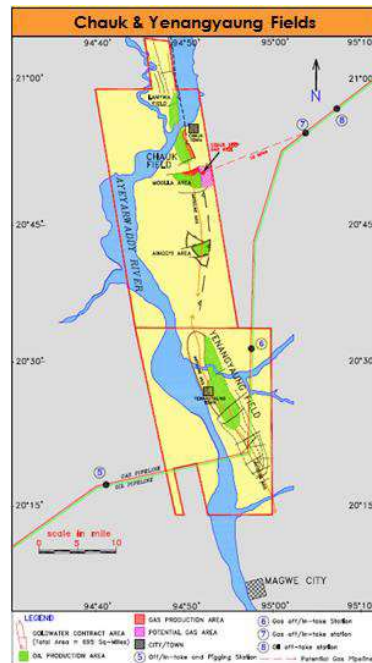

Mann Field³⁹

Mann Field is situated on the Northern plunging end of the 30 mile-long Mann-Minbu structure trend in the oil province of the Central Myanmar basin. Mann field was discovered in April 1970 by Myanmar Oil and Gas Enterprise (MOGE) and this discovery led to the Padaung formation. At 1 April 2014, 667 wells had been drilled in the field and approximately 120 million barrels of oil and 121 Bcf of associated gas had been produced. Estimated ultimate remaining recoverable oil is about 25 MMbbls. The field is currently producing about 1,450 barrels of oil per day from 351 wells.

MPRL E&P, formerly known as Myanmar Petroleum Resources Ltd, is the current holder of a Performance Compensation Contract originally signed between Baker Hughes Singapore and MOGE.

Myanmar-China Oil and Gas Pipeline Project

Myanmar-China Oil and Gas Pipeline Project was designed from 2008, with an overall length of 2,401.5 km. The crude oil pipeline starts from Made Island, on the west coast of Myanmar, and

³⁸ http://www.interraresources.com/operations_myanmar.asp

³⁹ <http://www.mprlexp.com/>

heads to Chongqing Province through Ruili, Yunnan. The overall length of pipeline in Myanmar is 770.5 km. The trunk line in China is 1,631 km, and the design throughput is 23 million tons/a.

The natural gas pipeline starts from Kyaukpyu, on the western coast of Myanmar, joins crude oil pipeline in Made Island with the two laying in parallel, to Ruili, Yunnan Province, and then to Nanning where it connects with Line II of West-East natural gas transmission. The length of pipeline in Myanmar is 793 m. In China, the trunk line is 1,727 m long, and its design gas transportation capacity is 12 billion m³/ a. The project is one of China's national energy passage projects.

The Myanmar section of the gas pipeline was completed on 12 June 2013 and gas started to flow to China on 21 October 2013. The oil pipeline was completed in Aug, 2014.

The project was implemented jointly by China National Petroleum Corporation (CNPC) and Myanma Oil and Gas Enterprise (MOGE). CNPC holds 50.9% stake and manage the project, and MOGE owns the rest.

Oil and Gas Pipeline Network

Domestic Pipelines

MOGE has been laying the pipes throughout Myanmar to expand its national pipeline network. Various sizes from 6” to 24” of pipeline were constructed. Total length is about 2100 miles

Export Pipelines

Project	Offshore	Onshore
Yadana(36”)	216 miles	39 miles
Yetagun (24”)	126 miles	43 miles
Zawtika (28”)	143 miles	143 miles
Shwe (32”)	65 miles	3 miles
Myanmar-China (40”) (Gas)	-	495 miles
Myanmar- China (32”) (oil)	-	481 miles

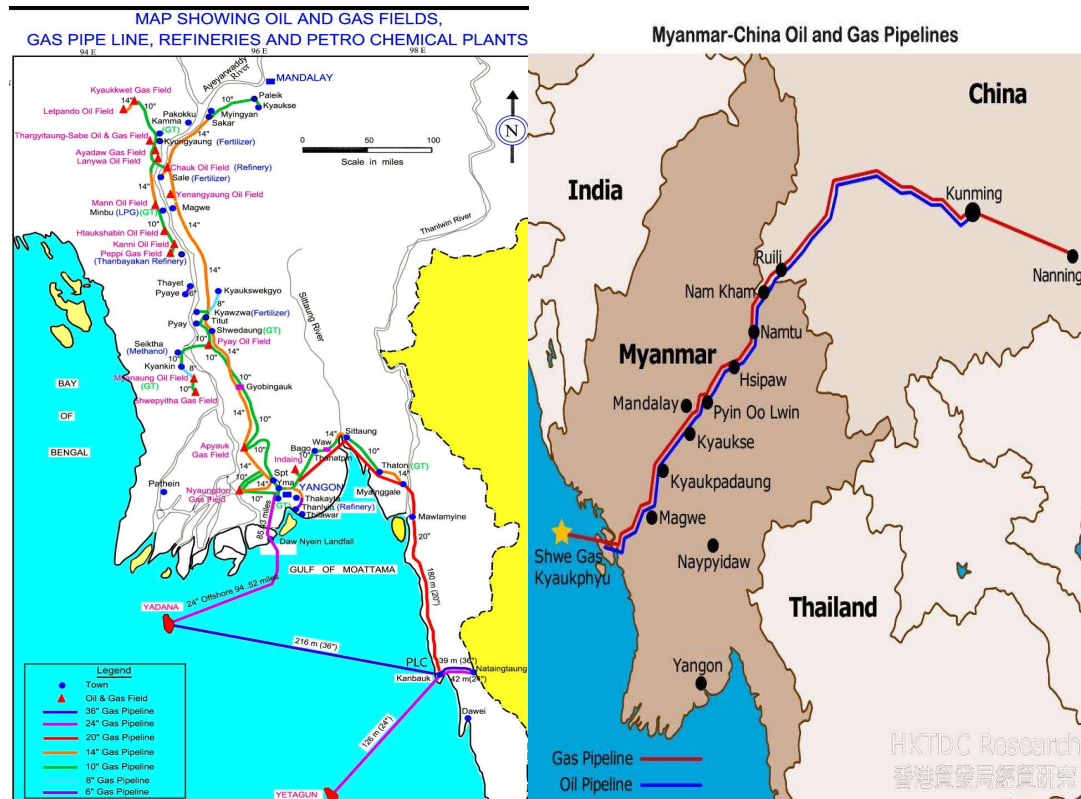

3.2.5 Register of licenses

MOGE maintains a list of licenses that includes the following information:

- Block reference;
- License holder;
- Activity (Study Period, Exploration, Production);
- MIC permit reference;
- Period of the licence (from “year” to “year”);
- Company Status (Active/ Pending);
- Location.

The list is not available on the MOGE website⁴⁰. However, we understand that the data listed above can be obtained directly from MOGE without restrictions or without cost. [Thus, the list of licenses provided by MOGE still lacks information on date of application, date of award, expiry date, the commodity being produced and the coordinates.](#) As noted in the first Myanmar-EITI report, we recommend MOGE to ensure that all records are computerised and kept up to date. The updated cadastre should be published on MOGE’s website. In the meantime, details of licences register are presented in Appendix 10 of the report.

3.2.6 Procedures for the award of Oil and Gas blocks

License transferring or awarding procedures

The current legal framework does not include requirements related to the application process to award oil and gas blocks and GOUM treats at its absolute discretion, the awards of oil and gas contracts and applications.

Before 2011, there was no Oil and Gas bidding process and the senior authorities allocated blocks to companies by direct negotiations. However, since 2010, Production Sharing Contracts are increasingly being awarded through licensing rounds. A bidding process and evaluation procedure has been implemented for the award of licenses.

MOGE is the most important actor conducting contract-award processes and negotiating Myanmar’s production sharing contracts (PSCs). MOGE holds the so-called “concessionaire’s right,” meaning that it is endowed in practice and by contract with “the exclusive right to carry out all operations” in Myanmar⁴¹, and is responsible for selecting companies to develop projects.

Prior to 2010, competitive bidding was not common in the country’s oil and gas sector, whereas the 2013 and 2014 rounds included a prequalification step, the circulation of a model PSC, a set of standard terms and conditions to guide bids, and public announcements of the successful companies. During these recent bid rounds for onshore and offshore acreage, MOGE was responsible for organising and managing bid rounds for oil awards, including the evaluation and selection process and negotiation of contracts with successful bidders.

The figure below outlines the application process used by GOUM to manage the development for available Oil and Gas blocks⁴².

⁴⁰ <http://www.mogemm.com/>

⁴¹ Preamble of the model PSC

⁴² The Oil and Gas Sector in Myanmar PP Presentation. Ministry of Energy, Myanma Oil and Gas Enterprise.2013

Graphic 8: Contracting and Bidding Process for Oil and Gas Blocks

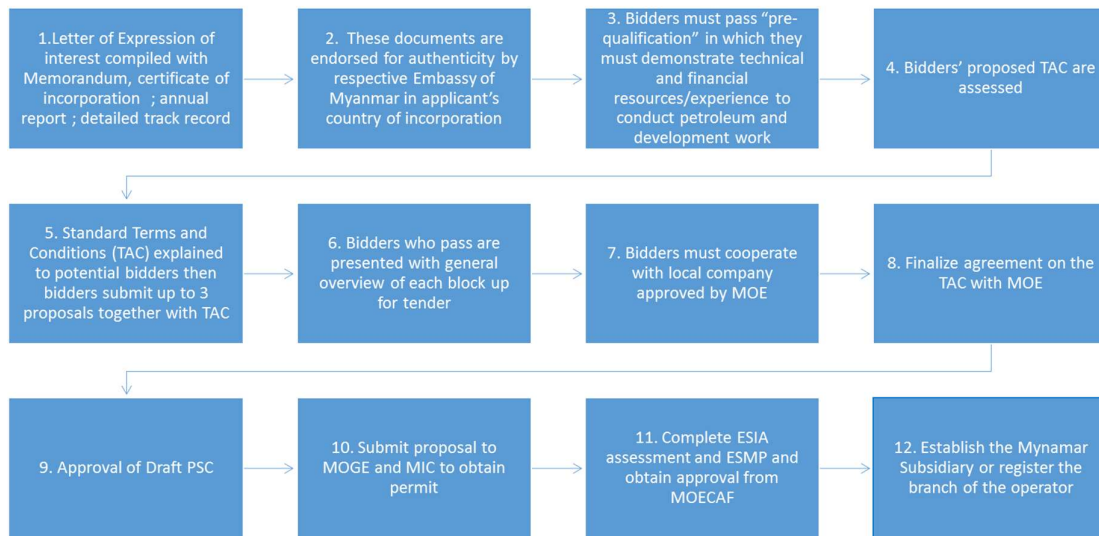

Information on the recipients of the license awarded and transferred

Permits Awarded

The first onshore bidding round for 18 blocks was launched in 2011 and nine blocks were awarded to international companies.

On 17 January 2013, MOGE announced the second round of bidding for 18 onshore blocks: 3 IPRs and 15 PSCs as follows:

- Expressions of Interest were due on 16 March 2013;
- 59 bidders were shortlisted for the second round of bidding;
- 26 shortlisted bidders submitted 53 bids for 16 blocks; and
- 11 bidders were awarded 16 onshore blocks on 10 October 2013.

Onshore block winners		
Company name	Country	Number of blocks
Production Sharing Contract		
ONGC Videsh	India	2
Eni	Italy	2
Petroleum exploration	Pakistan	2
Brunei National Petroleum	Brunei	1
Petronas	Malaysia	1
Pacific Hunt energy	Canada	2
CAOG S.a.r.l	Luxembourg	1
JSOC Bashneft	Russia	1
PTTEP South Asia Ltd and Palang	Thailand	1
Sophon Offshore	Thailand	1
Petroleum Recovery Contracts		
MPRL E&P Pte	British Virgin Islands	2

According to the press release dated 10 October 2013 and related to the above bidding process, 78 letters of Expression of Interest were received from 78 international companies as at 16 March 2013. 59 out of 78 companies were shortlisted by the committee led by Deputy Ministers of Ministry of Energy including technicians. The criteria were the endorsement of respected Myanmar Embassies, experience of Oil and Gas extraction, technology and financial capabilities as per the Certificate of Incorporation, Articles of Association, Memorandum of Association, latest Annual Report, latest Financial Statement. Details of the bid criteria used for the evaluation of the bids are presented in the Appendix 20 of the report.

Following the data overview, MoEE explained to the companies shortlisted, that their final proposals shall include MOU/MOA after cooperation with at least one Myanmar company registered at Ministry of Energy and that each company can apply for no more than 3 plots, and distributed forms of PSC Model Contract, Terms and Conditions and registered list of Myanmar companies.

26 companies submitted 54 final proposals for 16 plots. According to the press release, the list of 26 companies was published on the website of the Ministry of Energy at that time. We were not able to find out this list in the actual Ministry of Electricity and Energy website.

According to the press release, award procedures for final proposals were done as per selection criteria such as exploration period, procedures, expenditures, sharing ratios, experience and finance. According to the press release, the list of 11 companies retained for 16 plots was published on the website of the Ministry of Energy at that time. We were not able to find out this list in the actual Ministry of Energy website.

On 11 April 2013, MOGE announced another round of bidding for shallow water blocks (11 PSCs) and deep-water blocks (19 PSCs) as follows:

- Expressions of Interest were due on 14 June 2013;
- 61 bidders were shortlisted for the second round of bidding;
- 30 shortlisted bidders submitted bids on 15 November 2013; and
- 13 bidders were awarded 10 shallow water blocks and 10 deep water blocks in March 2014 as follows:

Offshore block winners		
Company name	Country	Number of blocks
Shallow water blocks		
BG Asia Pacific and Woodside Energy (Myanmar)	UK and Australia	2
Chevron (Unocal Myanmar Offshore Co, Ltd)	USA	1
Oil India Ltd, Mercator Petroleum Ltd and Oilmax Energy	India	2
ROC Oil and Tap Oil	Australia	1
Berlanga Holding	Netherlands	1
Transcontinental Group	Australia	1
Reliance Industries	India	2
Deep water blocks		
BG Asia Pacific and Woodside Energy (Myanmar)	UK and Australia	2
Ophir Energy Plc	UK	1
Shell Myanmar Energy and MOECO	Netherlands	3
Statoil and Conoco Philips	Norway and USA	1
Eni Myanmar	Italy	2
Total E&P	France	1

The criteria for the award of the above blocks were the endorsement of respected Myanmar Embassies, experience of Oil and Gas extraction, technology and financial capabilities as per the Certificate of Incorporation, Articles of Association, Memorandum of Association, latest Annual Report, latest Financial Statement. Details of the bid criteria used for the evaluation of the bids are presented in the Appendix 20 of the report.

On 7 May 2015, MOGE announced that another bidding round would not begin until 2016 at the earliest but did not disclose how many onshore or offshore blocks it would make available. We understand that no Oil and Gas permits have been awarded since the bidding rounds of 2013.

According to the register of licenses made available by MOGE, the following contracts related to the above awards were signed during 2014 and 2015:

Sr. No	Block	Company	Activity type (Study Period, Exploration, Production)
1	M-4	Oil India Ltd	Study
2	YEB	Oil India Ltd	Study
3	AD-3	Ophir Myanmar	Study
4	M-8	Barlanga Myanmar Pte. Ltd	Study
5	MD-5	Shell Myanmar Energy Pte.Ltd	Study
6	A-5	Unocal Myanmar Offshore Co.,Ltd	Study
7	A-4	BG Exploration&Production Myanmar Pte. Ltd / Woodside Energy (Myanmar)Pte.Ltd	Study
8	AD-2	BG Exploration&Production Myanmar Pte. Ltd / Woodside Energy (Myanmar)Pte.Ltd	Study
9	A-7	Woodside Energy (Myanmar) Pte. Ltd./BG Exploration&Production Myanmar Pte. Ltd	Study
10	AD-5	Woodside Energy (Myanmar) Pte. Ltd.	Study
11	YWB	Total E&P Myanmar	Study
12	M-15	CFG Energy Pte.Ltd	Study
13	MD-2	Eni Myanmar B.V/Total E&P Myanmar	Study
14	MD-4	Eni Myanmar B.V/Total E&P Myanmar	Study
15	M-17	Reliance Industries Ltd	Study
16	M-18	Reliance Industries Ltd	Study
17	AD-10	Statoil Myanmar Pte. Ltd	Study
18	M-7	Tap Energy(M-7) Pte Ltd	Study
19	PSC-K	Eni Myanmar B.V	Exploration
20	RSF-5	Eni Myanmar B.V	Exploration
21	IOR-4	MPRL E&P Pte. Ltd	Study
22	IOR-6	MPRL E&P Pte. Ltd	Study
23	MOGE-3	PTTEP South Asia Ltd.	Exploration
24	B-2	ONGC Videsh Ltd	Exploration
25	EP-3	ONGC Videsh Ltd	Exploration
26	EP-4	Bashneft International B.V	Exploration
27	PSC C-1	Pacific Hunt Energy Corporation	Preparation
28	PCS-H	Pacific Hunt Energy Corporation	Preparation
29	IOR-5	Petronas Carigali Myanmar Inc	Exploration
30	IOR-7	Petronas Carigali Myanmar Inc	Exploration
31	EP-1	Brunei National Petroleum Co., Sdn.Bhd. (PB Myanmar Co., Ltd. / Petronas Carigali Myanmar Inc	Exploration
32	MOGE-4	CAOG Pte. Ltd	Exploration

[MOGE did not submit the list of applicants involved on the above licences awarded through bidding process.](#)

Permits transfers

MOGE consent is required in order for a company to transfer its interest under a PSC⁴³. Consent will take 90 days. The government has no pre-emptive rights. For the year ended 31 March 2015, we understand that there were no interests that were transferred⁴⁴.

Technical and financial criteria used

For the bid rounds under the new process (bidding rounds of 2013), MOGE set out the following bid assessment criteria:

- Technical capability;
- Financial capability;
- Prior experience in Myanmar;
- Financial terms for the block; and
- Experience relevant to the block (e.g. deep-water).

MOGE's Shallow/Deep Offshore PSC Selection Criteria allocated scores as follows:

No	Description	%
1	Work Programme and Expenditure	60%
2	Production Split	20%
3	Signature Bonus & Working Experience	10%
4	Financial Standing	10%
Total		100%

Details of the bid criteria used for the evaluation of the bids are presented in the Appendix 20 of the report.

Moreover, for onshore and shallow water blocks, potential bidders must partner with at least one national owned company which is registered with the Energy Planning Department (EPD). Bidders for deep water offshore blocks are not required to partner with a national company. With regards to the 2011 bid round for onshore blocks, local partners are thought to have acquired between 5% and 15% in the new projects.⁴⁵ The 2013 bid rounds have also resulted in domestic companies holding significant economic interests in joint ventures and PSCs. According to a study conducted by Global Witness, 29 of the 36 blocks awarded by MOGE in the 2013-14 rounds featured a Myanmar company as a minority partner.⁴⁶

After agreement between MoEE and selected candidates, the Ministry of Energy requested comments from respective Ministries such as the Union Attorney General Office, Union Auditor General Office, the Ministry of National Planning and Economic Development, Ministry of Planning and Finance and Central Bank for the draft contract.

Once MoEE has received comments from the relevant Ministries, draft contracts are submitted to the Economic Committee Cabinet and Myanmar Investment Commission for authorisation. After approval and permission of Myanmar Investment Commission, successful bidders can enter into the PSC Contracts.

The list of the selected candidates was announced on the Ministry of Energy Website which held a press release for announcement of selected candidates on 26 March 2014. We were not able to find out this list in the actual Ministry of Electricity and Energy website.

⁴³ Clause 17.2 of the Model PSC

⁴⁴ Interview with officials from MOGE, 2017

⁴⁵ Chandler and Khin Cho Kyi, 2014.

⁴⁶ Global Witness, Who Are the Real Winners of Myanmar's Latest Oil and Gas Block Sales (2014), <http://www.globalwitness.org/sites/default/files/Myanmar/MBriefingUpdated.pdf>, pp. 8 – 11

Efficiency and effectiveness of these systems

The competitive bidding rounds organised by in 2013 and 2014 provides a more transparent system of awarding petroleum contracts. MOGE plays a central role in the licensing process in Oil and Gas by cumulating the contractor and regulatory functions. The details on the process, other than final results, are rarely published. Moreover, there is a legal vacuum in that area.

We therefore recommend that public disclosure of detail of candidates. We also recommend the review of MOGE mandate and separate its current regulatory function into another part of the Ministry of Electricity and Energy, to remove conflicts of interests.

3.2.7 Contract types

The Oil and Gas sector in Myanmar is governed by three types of contracts, as set out below:

- Production Sharing Contracts (PSCs): for Offshore and Onshore projects
- Performance Compensation Contracts (PCC): for onshore projects; and
- Improved Petroleum Recovery Contracts (IPRs): for onshore projects

Only the terms and conditions of PSCs are published on the MoEE website⁴⁷. PSCs in Myanmar included the following terms:

	Onshore PSCs	Shallow water PSCs	Deep water offshore PSCs
Management	MOGE is responsible for management of operations. Contractor is accountable to MOGE for the execution of operations and the associated costs.	MOGE is responsible for management of operations. Contractor is responsible to MOGE for the execution of such operations and the associated costs.	MOGE is responsible for management of operations. Contractor is responsible to MOGE for the execution of such operations and the associated costs.
Preparatory Period:	Six months (after signing of contract), which may be extended.	Six months, which may be extended.	Six months, which may be extended.
Exploration Period	Initial term 3 years, 1 st extension 2 years, and 2 nd extension 1 year. Seismic and well commitments: negotiable	Initial term 3 years, 1 st extension 2 years, and 2 nd extension 1 year	Initial term 3 years, 1 st extension 2 years, and 2 nd extension 1 year
Production Period	20 years from completion of exploration or according to sales contract, whichever is longer	20 years from completion of exploration or according to sales contract, whichever is longer	20 years from completion of exploration or according to sales contract, whichever is longer
Signature bonus:	Amount agreed in the contract. Payment within 30 days of approval from MIC on EIA/SIA	Amount agreed in the contract. Payment within 30 days of entering Exploration Period	Amount agreed in the contract. Payment within 30 days of signing PSC [amended to 30 days after start of Exploration Period]
Relinquishment:	100% at end of Exploration Period, less Discovery Areas and Development and Production Areas.	100% at end of Exploration Period, less Discovery Areas and Development and Production Areas	100% at end of Exploration Period, less Discovery Areas and Development and Production Areas
Royalty:	12.5% of available petroleum (10% for PSC up to 2012)	12.5% of available petroleum (10% for PSC up to 2012)	12.5% of available petroleum (10% for PSC up to 2012)
Cost recovery	Limited to 50%	Limited to 50% in water depth of 600 feet or less; 60% for water depth exceeding 600 feet	Limited to 60% in water depth of 2,000 feet or less; 70% for water depth exceeding 2,000 feet
Production split:	Progressive depending on production. Ranges from 60 to 90% for crude oil and natural gases	Progressive depending on production. Ranges from 60 to 90/85% for crude oil and 65/60% to 90% for natural gases	Progressive depending on production. Ranges from 60/55% to 85/80% for crude oil and 60/55% to 90/80% for natural gases

⁴⁷ <http://www.energy.gov.mm/>

	Onshore PSCs	Shallow water PSCs	Deep water offshore PSCs
Production bonus	Progressive depending on production. Ranges from USD 0.5 million to 6.0 million	Progressive depending on production. Ranges from USD 1 million to 10.0 million	Progressive depending on production. Ranges from USD 1 million to 10.0 million
Domestic requirements:	20% of crude oil and 25% of natural gas from the contractor's share of profit realised from the sale of petroleum on the domestic market, at 90% of fair market prices	20% of crude oil and 25% of natural gas of contractor's share of profit realised from the sale of petroleum on the domestic market, at 90% of fair market prices	20% of crude oil and 25% of natural gas of contractor's share of profit realised from the sale of petroleum on the domestic market, at 90% of fair market prices
Training fund:	USD 25,000 pa during exploration USD 50,000 pa during production	USD 25,000 pa during exploration USD 50,000 pa during production	USD 50,000 pa during exploration USD 100,000 pa during production
State participation	15% with MOGE option to increase to 25%	Up to 20% with MOGE option to increase up to 25%	Up to 20% with MOGE option to increase up to 25%
Other	EITI implementation Contractor must include a company registered in Myanmar	EITI Implementation CSR Obligations. Contractor must include a company registered in Myanmar	EITI Implementation CSR Obligations. Contractor must include a company registered in Myanmar

Graphic 9: below shows the production sharing mechanism for petroleum contracts ⁴⁸:

Production Sharing Contract

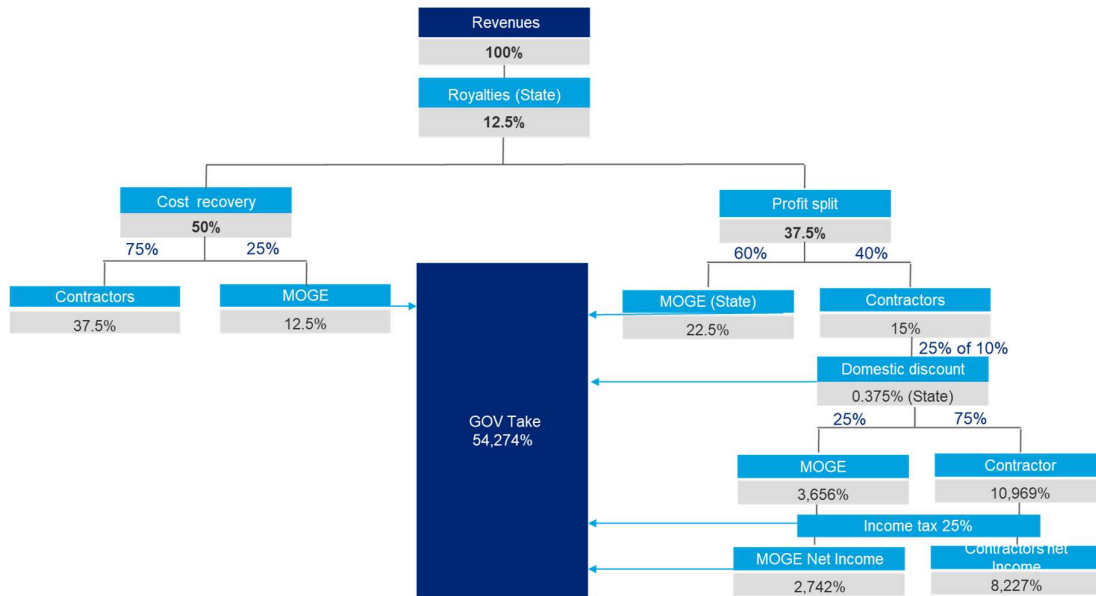

⁴⁸ For PSC up to 2012 royalties were 10% of available petroleum.

Performance Compensation Contracts (PCC)

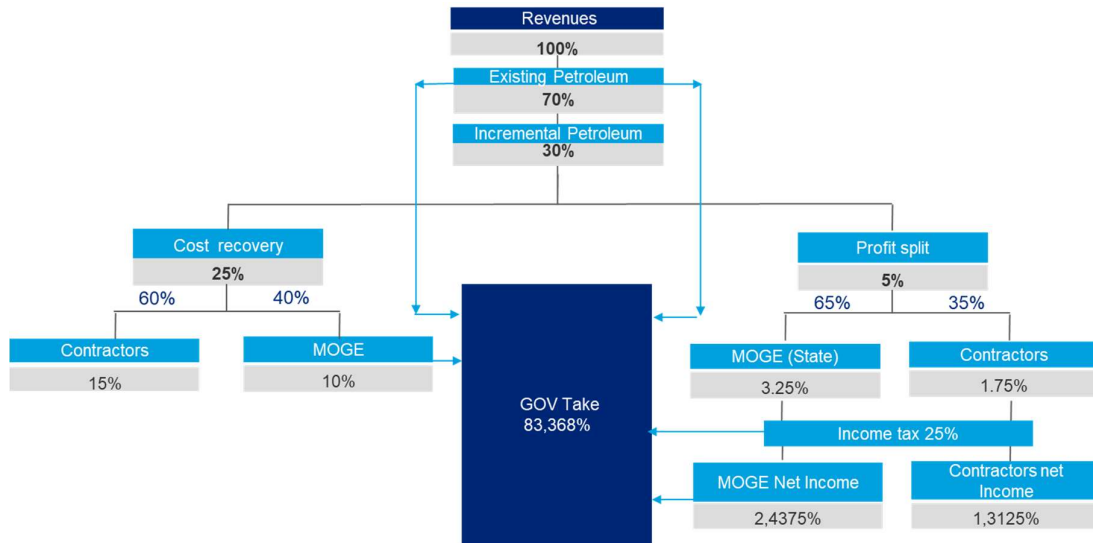

Improved Petroleum Recovery Contracts (IPRs)

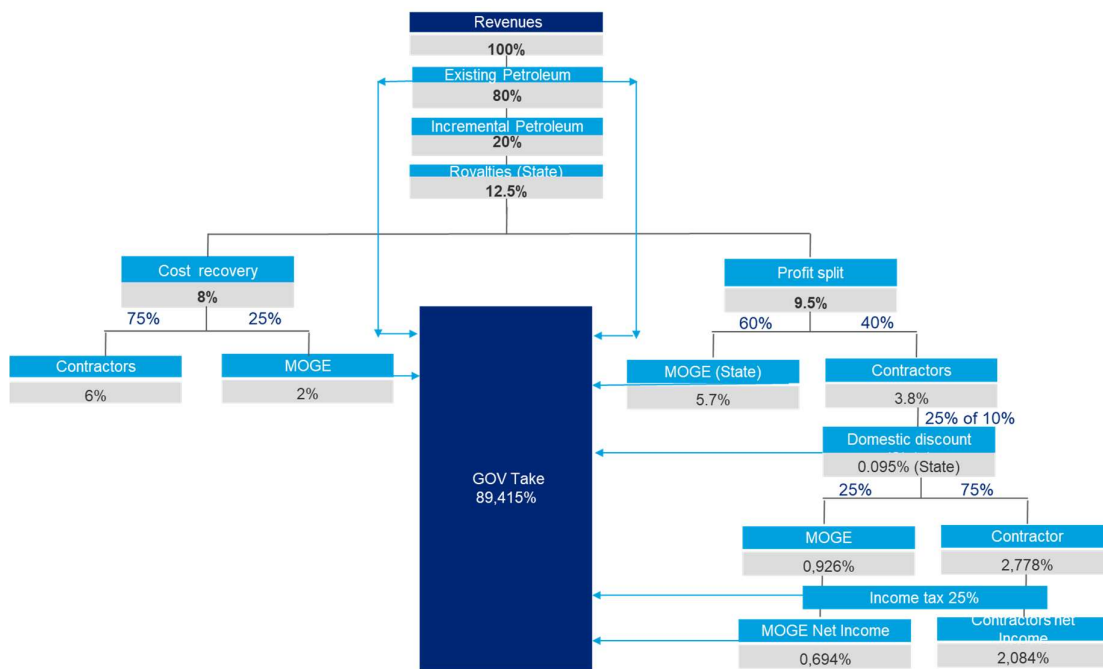

3.2.8 Tax regime applicable to Oil and Gas companies

Companies in the oil and gas sector are subject to a 25 % tax on profits under the Income Tax Law. There is a five-year tax holiday under the FIL of 2012 (the 2012 FIL), beginning when the commercial production period starts in respect of PSCs approved under the 2012 FIL.

Depreciation may be deducted in calculating a company's income tax liability at the following rates, subject to the applicable cost recovery limit:

Category	Depreciation rate
Plant and machinery, pipelines	5 %
Oil rigs, survey equipment	10%
Shaft drilling equipment	20%

Under the 2017 Union Tax Law, Commercial Tax shall be levied at 5 % on exporting crude oil and Special Goods Tax shall be levied at 8 % on exporting natural gas.

Customs duties vary depending on the customs classification of the goods. Companies with projects approved under the FIL may receive either an exemption or relief from customs duty as an investment incentive.

3.2.9 Policy on disclosure of contracts

In Myanmar's oil and gas sector, operations are mainly governed by contracts between Myanmar Oil and Gas Enterprise (MOGE) – a 100% State Owned Enterprise– and private operators. The existing Oil and Gas contracts are predominantly PSCs entered into by MOGE and private operators. PSCs are all based on a model contract that MoEE has used for several years.

The typical model contract between oil and gas operators and MOGE (PSCs) includes a confidentiality clause by which the parties agree not to disclose "data and information purchased or acquired" or obtained "during the course of operations," but the clause does not expressly prohibit disclosure of the contracts themselves. Moreover, the Oil and Gas legislation does not include any express restrictions on the public disclosure of contracts and licenses by the government.

In practice, contracts are confidential, but a model short-form "terms and conditions for PSCs"⁴⁹ (which sets out the key financial and production sharing regime) is publicly disclosed by MoEE but does not include the full terms of the contracts.

Furthermore, we received the standard terms and conditions of PSC, PCC and IPR for onshore and offshore blocks from OGD. These standards Terms and Conditions are presented in Appendix 12 of the report.

A copy of the PSC between MOGE and Total E&P for the Yadana project dated 9 July 1992 is also available on the MoEE website⁵⁰ but no other long-form PSCs are publicly available. Under this contract, information regarding the exploration period, the work programme and expenditure, production periods, royalties, production shares, data fees, production bonuses for both crude oil and gas, domestic requirements, cost recovery provisions, training and research and development funds, state participation, income tax and tax holiday periods, profit sharing and arbitration, and governing laws are described. However, the contract does not include the amount of signature bonuses paid by Total.

⁴⁹ <https://www.google.tn/url?sa=t&rct=j&q=&esrc=s&source=web&cd=2&cad=rja&uact=8&ved=0ahUKEwjgnZbP-8rYAhXMDuwKHVdwBNUQFggMAE&url=http%3A%2F%2Fcharltonsmyanmar.com%2Fwp-content%2Fuploads%2F2013%2F10%2FModel-Production-Sharing-Contract-Onshore.docx&usg=AOvVaw0X90Y78zuulE4-E7ubta31>

⁵⁰ <http://archive.resourcegovernance.org/sites/default/files/Total%20PSC.pdf>

We understand that the Myanmar EITI Leading Committee is currently discussing whether or not to follow the encouragement provided in the 2016 EITI standard and include disclosure of oil and gas contracts as a part of EITI work plan.

3.2.10 State's participation in the Oil and Gas sector

The Constitution of the Republic of the Union of Myanmar 2008, stipulates that the state is the ultimate owner of all-natural resources including Oil and Gas. The State's intervention in the Oil and Gas sector is made through the State-Owned Enterprise "MOGE" and the Production Sharing Contracts signed with contractors.

MOGE – a 100% State Owned Enterprise (SOE)

In 1989, Myanmar enacted its State-Owned Economic Enterprise Law, identifying key areas of economic activities where the State would exercise control via SOEs. Although this law remains in effect, the Foreign Investment Law largely determines, in practical terms, how GOUM exercises its involvement in the extractive industries sector. For example, in contrast to the State Owned Economic Enterprises Law, GOUM no longer exercises its right to monopolise the extraction of resources.

Myanma Oil and Gas Enterprise (MOGE) was established in 1963 after nationalisation of the Burmese petroleum industry. MOGE is a 100% state-owned economic enterprise (SOE) overseen by the Ministry of Electricity and Energy (MoEE).

MOGE appears to play a dominant role in all aspects of the state's management of the sector, including policy-making, regulation and oversight, commercial participation and revenues collection. It supervises mapping for the oil and gas sector, provides detailed maps of all oil and gas blocks, and sets procedures for bidding and licensing.

MOGE, which is responsible for E&P of petroleum within Myanmar, and has exclusive rights to carry out all oil and gas operations with private contractors. MOGE's most significant commercial obligations lies in its participation in oil and gas project groups. It is likely that this role generates the largest share of MOGE's revenues and accounts for the largest share of the company's expenditures. According to the Foreign Investment Law (2012)—which modelled on mandatory established in the State-Owned Economic Enterprises Law (1989)—any private company that wants to extract oil or gas must enter into a joint venture with MOGE or a private Myanmar company. The Foreign Investment law is currently being revised.

MOGE's Commercial role

Core features of MOGE's commercial role in oil and gas project groups include:

- "Equity participation," meaning that MOGE is at least a 15-25% owner of the ventures created to manage petroleum projects.⁵¹ MOGE's equity participation in the year 2014-2015 is detailed in table 12 below. We understand that there are no mandatory requirements regarding the State's interest in JV. We also understand that MOGE does not hold any interests in the capital of Oil and Gas operators;
- Its role as the recipient of the State's share of profit oil and gas under contractual production-sharing arrangements (the share has been reported to range from 60 to 90% once allowable costs have been recovered);⁵²
- Formal power to "be responsible for the management of Petroleum Operations," principally via its chairmanship and majority membership in the Management Committee to be set up with its contractors for the project. The model contracts we have seen call for decisions by this Management Committee to be made unanimously, which gives both MOGE and the Contractor veto power over key decisions.⁵³

⁵¹ Clause 19.1 of the Model PSC

⁵² Clause 9.7 of the Model PSC

⁵³ Annex E of the Model PSC

MOGE's role in revenues collection

Beyond its commercial responsibilities, MOGE plays major role as a recipient of revenues resulting from the oil and gas contracts provisions.

The model PSC provides MOGE with a significant role in the monitoring and collection of various payment streams. In accordance with the model PSC, MOGE is responsible for taking and marketing the State's share of profit oil, as well as collecting signature and production bonuses, data fees, and training funds that the contractor pays in cash. Section 3.6.2 provides details of the revenues collection process in the Oil and Gas sector including the transfers between MOGE and other Government Agencies.

MOGE's role in monitoring the contractor's performance and law enforcement

According to the model PSC, MOGE holds most of the important oversight powers associated with oil and gas projects, including:

- approval of contractor appraisal programmes, development plans, work plans and annual budgets (sections 6 – 8 of the model PSC);
- monitoring of contractor performance against agreed obligations during exploration periods (sections 4 – 5 of the model PSC);
- assessment of contractors' valuation of crude oil (section 12 of the model PSC); and
- Oversight of contractor training programs (section 15 of the model PSC).

MOGE also plays a central role in:

- supporting of extractive projects by providing logistical assistance, identifying subcontractors and service providers, and supporting contractor companies to obtain visas, work permits, approvals, transportation and security;
- strengthening of commercialisation capacities by setting up joint ventures with private companies to provide support services - in particular, seismic surveys, drilling support and pipeline development; and
- allocation of licenses; monitor of implementation of the country's legal regime; and efforts to develop commercial capacity (see Section 3.2.5 of this report).

MOGE ownership/partnership interests

MSG agreed that MOGE should disclose their level of beneficial ownership in oil and gas companies operating in Myanmar, including those held by SOE subsidiaries and joint ventures, and any changes in the level of ownership during the reporting period. Details of public interests reported by MOGE is set out in the following table.

Table 18: State participation in Oil and Gas projects as at 31 March 2015

	Project	Operator	%	Interest distribution (in %)							
Offshore projects	Yadana	TOTAL	31.2	MOGE	15.0	UNOCAL	28.3	PTTEP	25.5		
	Yetagun	Petronas	40.9	MOGE	20.5	Nippon Oil	19.3	PTTEP	19.3		
	Shwe	Daewoo	51.0	MOGE	15.0	ONGC Videsh Ltd	17.0	Gail JJ India Ltd	8.5	Korea Gas Corporation	8.5
	Zawtika	PTTEP	80.0	MOGE	20.0						
Onshore projects	Chauk Oil Field	Goldpetrol	45.0	MOGE	55.0						
	YNG Oil Field	Goldpetrol	45.0	MOGE	55.0						
	Mann Oil Field	MOGE	65.0	MPRL	35.0						

Source: MOGE

Moreover, MOGE hold 7.3% and 49% in the SEAGP and SEAOP projects respectively.

According to the data provided by MOGE, there is no state participation in the equity of the Oil and Gas companies as at 31 March 2015. Furthermore, the percentage of participation in the JV has not changed between 31 March 2014 and 31 March 2015.

3.2.11 Financial relationship between MOGE and the State

MOGE earnings represent a major share of the State's revenues, ranging from 67% in fiscal year 2009/10 to a low of 14.5%⁵⁴ in 2014/15.

At the beginning of 2012, the Government of Myanmar enacted progressive changes to reduce the payments that profitable SOEs are obligated to pay to the State, and to increase these companies' abilities to keep these revenues. Prior to the 2012/13 fiscal year, SOEs were required to pay all of their net profits into the State Fund Account (SFA), split between 30% income tax and 70% as "SOE contributions."⁵⁵

The reforms launched in 2012/13 dramatically reduced these payment obligations. SOEs continue to receive allocations each year from the budget, which are designed to meet all of their running costs (including operational expenditure, capital costs, etc.), except for raw materials purchases. These raw materials costs are to be paid from the SOE's accounts, which can carry a balance from one year to the next⁵⁶. Government officials inform us that the raw materials costs represent a relatively small proportion of the costs of extractive industry SoEs, meaning that the large majority of their costs are covered by the annual budget allocations. For the case of MOGE, we noted that no budget allocation has been made for the fiscal year 2015-16. This is explained by the large profits made which broadly cover the costs incurred during the period.

Once the costs have been covered, SOEs are now required to pay 45% of net profits into SFA (income tax at a reduced 25% rate and 20% as "state contribution")⁵⁷.

These policy reforms are in line with the government's objective of making SOE revenue flows more akin to those of commercial companies operating in the normal course of business. They appear to allow profitable SOEs to keep large revenues in their Other Accounts, without clear limitations on what they can do with those funds. From the government perspective, the changes seek to "enable profitable SOEs to become financially independent." The Government's rationale suggests that the objectives of (a) increasing incentives in order to improve efficiency and commercial awareness by giving companies leadership more control over profits, and (b) empowering the companies to undertake more ambitious investment programmes to widen their activities.

All residual revenues (after a profitable SEE pays these taxes and contributions) may be retained in the SEE's "Other Accounts" as the company's "own funds for the purpose of accumulation. The amounts from these Other Accounts is not transferred to any other Government Entity.

In 2014/2015, the sums retained by MOGE after the payment of transfers to the central government equalled 41% and 6% of total oil and gas revenues. MOGE deposited approximately \$1.2 billion (1,2 trillion kyat) into its "Other Accounts" that year and the five-leading upstream SOEs taken together deposited \$ 1.3 billion (1.3 trillion kyat) into these accounts.

⁵⁴ EITI figures

⁵⁵ Treasury Department, 2014.

⁵⁶ Responsibility to pay for raw materials costs has been transferred progressively to the SEEs over time. Beginning in fiscal year 2012/13, SEEs were required to cover 78 percent of their raw materials expenditures from their own accounts. Beginning in 2013/14, profit-making SEEs were required to cover 100 percent of their raw materials expenditures, while loss-making SEEs were required to cover 80 percent. Beginning in 2015/16, both profit-making and loss-making SEEs will be required to cover 100 percent of their raw materials expenditures. Source: consultations with Ministry of Finance, *Union Budget Law*, 2015, 9 April 2015, Part III

⁵⁷ Budget Department, Ministry of Finance

The balance, receipts and expenditures of MOGE Other Accounts in FY 2014-2015 is as follows :

Table 19: MOGE "Other Accounts," as at 31 March 2015, per EITI report

	Amount (in million MMK)
Opening balance as at 1 April 2014	2,883,385
Add: Total Received Amount	1,859,943
Crude	159,093
Gas	385,569
Other (CNG, Service, Other)	1,315,281
Less: Total Expenditure Amount	(680,696)
Material	(36,958)
Income Tax	(357,632)
State Contribution	(286,106)
Closing balance as at 31 March 2015	4,062,632

Source: MOGE

We understand that in the case of MOGE, MoEE exercises a degree of control over the ways in which MOGE may spend its funds. But, there is no clear rules governing MOGE expenditures and MOGE's use of its retained profits. This situation makes difficult to assess the balance between the retained profits and the SOEs' needs for funds to cover its administrative and operational charges. The excessive retained profits may in fact be used to cover the needs for other critical public programmes.

Control of MOGE accounts

We also understand that the amounts held in the Other Accounts are verified and approved by the Union Auditor General's Office.

In keeping with the State Fund Accounts Directive, which was issued in 1989, SOEs (including MOGE) are required to submit a summary statement of revenues and expenditures to MoPF annually. However, data on the revenues, transfers or expenditures of the extractive sector SOEs (including MOGE) are not systematically published and what few data are available are often aggregated to a degree that makes them difficult to analyse. The MOGE statement of revenues and expenditures for the year 2014/2015 is detailed as follows:

Table 20: MOGE total revenues and expenditures in FY 2014-2015

	In million MMK			
	Current	Capital	Financial	Total
Revenues	1,869,668	14,681		1,884,349
Expenditures	(1,401,302)	(76,248)	(116,441)	(1,593,992)
Total	468,366	(61,568)	(116,441)	290,357

Source: MoPF

Payments received, and transfers made by MOGE during the fiscal year 2014-2015 are summarised as following:

		In million MMK
Contractual and fiscal information	MOGE	
Total payments made to the government		1,364,939
<i>Transfers to IRD and Customs Department</i>		745,888
<i>State contribution declaration</i>		286,106
<i>Transfers to OGPD (formerly EPD)</i>		332,946
Transfer of funds, earnings, reinvestment, and third party financing	Other than the transfer of funds through state contribution payment, there are no other fund arrangements with the government or third party.	
Payments made to finance/ fund social services, public infrastructure, fuel subsidies and national debt	Domestic gas consumption subsidies :	181,176
Loans/borrowings extended from the national government or department agencies	See section 6.8	
Loans or loan guarantees to mining, oil and gas companies operating within the country	See section 6.8	
Quasi-fiscal expenditures	None	

Source: EITI

3.2.12 Local contents and social payments

PSCs require the contractor to supply the domestic market with 20% of crude oil and 25% of natural gas of its share of profit on petroleum sales to the domestic market, at 90% of fair market prices.

PSCs in the 2013 bid rounds include specific obligations with regards to employment and training of Myanmar citizens, providing industrial training and education of Myanmar nationals selected by MOGE, and giving preference to Myanmar goods and services.⁵⁸ According to the new PSCs, contractors are required to make the following contributions:

- Training Fund: US\$25,000 per annum during exploration, US\$50,000 per annum during production;
- Research and Development Fund: 0.5% of the contractor's share of profit on petroleum

The model Production Sharing Contract (PSC) does not require a social investment programme but there is discussion within MIC of strongly encouraging all investors to put aside a budget for CSR programmes of 1-3% of their pre-tax profits, and to take decisions on spending this in cooperation with local communities and authorities.

Currently PSCs simply require the company signing the agreement with MOGE to "expedite the Corporate Social Responsibility in the area in accordance with the company's policy"⁵⁹ which leaves the approach up to the individual company. This provides for flexibility in designing a programme but assumes that companies have the appropriate experience in designing useful CSR/social investment programmes. The tendency is for companies to contribute voluntarily to obtain a de facto "social licence to operate", especially in areas where there is conflict, competing land uses, relocation of people or economic activities.⁶⁰

⁵⁸ Sections 15 and

⁵⁹ Clause 17.2

⁶⁰ See CSR programme of MPRL E&P Pte Ltd as an example of voluntary community development contributions

3.2.13 Reforms in the Oil and Gas sector

Starting from the FY 2014-2015, the payments related to signature bonus, production bonus and royalties are collected by MOGE and directly transferred to EPD and no more kept in the accounts of MOGE.

Starting from the fiscal year 2015-2016, MOGE has set up a CSR fund. 2% of MOGE's net profit will be paid into this fund every year.

The Ministry of Environmental Conservation and Forestry issued the National Environmental Quality Emission Guideline (EQEG) on 29 December 2015 as Notification No. (615/2015). EQEG provides the basis for the regulation and control of noise and vibration, air emissions and liquid discharges from various sources in order to prevent pollution for the purposes of protection of human and ecosystems. EQEG applies to both onshore and offshore oil and gas sectors, including seismic exploration, exploratory and production drilling, development and production activities, offshore pipeline operations, offshore transportation, tanker loading and unloading, ancillary and support operations, and decommissioning.

3.3. Mining sector

3.3.1 General context of the mining sector

Myanmar has diverse and largely untapped geological resources which will make mining a significant driver of the country's economic development in the decades to come. Myanmar's mining sector is not as developed as its oil and gas sector as the level of foreign investment is much lower. However, the country has extensive mineral resources, which is attracting considerable interests from international mining companies.

Mineral deposits cover all sectors, including base metals (gold, copper, silver, lead, zinc, tin, manganese and antimony), industrial minerals (cement, clays, gypsum, fertilizer bases, dolomite, limestone, salt and barite), energy sources (coal and uranium) and gems (jade, rubies, spinel, peridot, sapphire, kyanite)⁶¹.

Myanmar's mining sector is made up of large-scale mining, small-scale artisan extraction and a certain amount of informal mining. The mining sector operates both through granting concessions to private investors and through State Owned Mining Enterprises placed under the authority of the Ministry of Natural Resources and Environmental Conservation (MONREC).

In the precious gem subsector, around 90% of the world's supply of Rubies are sourced from Myanmar and the country is also the world's largest single source of Jade. The Government of Myanmar prohibits the extraction of precious gems by foreign investors.

Copper makes up the largest export metal in the mining sector, while silver, lead, tin, tungsten and antimony deposits are widespread across the country.

⁶¹ 2012 Minerals Yearbook, Burma, U.S. Geological Survey

3.3.2 Mineral resources

a) Gems and Jade

Myanmar rubies and jadeite continue to command the highest prices on international markets, and Myanmar is the world's single largest source of jadeite (jade) globally, accounting for an estimated 90% of global production⁶².

Coloured gemstones are mined in approximately 50 countries worldwide. Of these, Myanmar is renowned for its abundance of high quality gemstones, including world-class rubies, sapphires (ruby and sapphire are both a variety of corundum) and jadeite. Other gemstone varieties found in Myanmar include spinel, diamonds, tourmaline, peridot, topaz, garnet, moonstone, lapis lazuli, chrysoberyl, amber, quartz, and more. There are also a few extremely rare varieties of gemstone that are unique to Myanmar and which have never been found anywhere else in the world.

Myanmar's main gem-producing areas are geographically located along the North-Eastern mountainous regions, with jadeite deposits almost exclusively in Kachin state as well as Sagaing, and other coloured gemstones in Shan, Mandalay, Kachin, Kayin and Tanintharyi. Many of the known

gemstone tracts are in, or bordering, conflict zones. The major gemstone deposits in Myanmar include:

- the large jadeite areas in Hpakant (Kachin State) and Hkamti (Sagaing), and
- the Mogok Stone Tract (Mandalay Division) famous for its ruby and sapphire deposits

In Myanmar, gems and jadeite are sold to international buyers at the annual Gems Emporium, held in Nay Pyi Taw, as well as in shops and markets across the country. Foreigners are prohibited by law from extracting Myanmar's gemstones, including entering into joint venture partnerships with Myanmar citizens. Only Myanmar citizens are allowed gemstone permits.

While a number of geological surveys of Myanmar's gem-producing areas have been undertaken over the past decades, the quality and reliability of these is not known, and there is very little publicly available information. The lack of clear and up-to-date geological information leads to a considerable amount of speculation and misinformation about potential gem-yielding areas, makes the allocation of gemstone production permits more challenging, and is also therefore a deterrent to investors. This is an area requiring further attention and strengthening.

Coloured Gemstones

The Mogok valley in Mandalay Division, around 150 miles North East of Mandalay, is probably the most well-known of Myanmar's gem producing areas due to its famous ruby deposits, and the Mogok stone tract has been known throughout history as the 'Land of Rubies'. The allure of certain wealth in return for control of the gemstone mines has fuelled conflicts in this area throughout history. It is commonly estimated that 80 - 90% of the world's rubies come from Myanmar⁶³.

In the 1980s and 1990s rubies from newly discovered deposits in Mong Hsu in Shan State flooded the international ruby markets, mostly via Thailand. This was followed by promising ruby and sapphire deposits in Namya in Kachin State, near Hpakant and the Chinese border, particularly during the 1990s. The quality of rubies from these deposits is not considered as good as those from Mogok.

Jadeite

Jadeite (jade) is found predominantly in the Hpakant area of Kachin State as well as Mohnyin, and also in Hkamti Township in Sagaing Division. Myanmar is the world's main commercial source of jade although jadeite also occurs in Guatemala, Japan and the US. It is commonly estimated that up to 90% of the world's jade is now mined around the Hpakant area and sold to Chinese buyers¹⁸. Myanmar's 'imperial jade' is the most valuable in the world with its translucent to almost transparent bright emerald green colour.

⁶² Source: Gemstone Sector Review, Emma Irwin – July 2016

⁶³ Source: Gemstone Sector Review, Emma Irwin – July 2016

b) Other minerals

Cathode Copper

Cathode Copper is produced from S & K Mine, Monywa in Sagaing division, Upper Myanmar. The mine started its commercial production in January 1999 and annual production in FY 2014-2015 was approximately 36,000 tonnes. The Mine is operated by Myanmar Ivanhoe Copper Company Ltd (MICCL) a 50:50 Joint Venture Company between the Ivanhoe Holding Ltd and the No. 1 Mining Enterprise, a state-owned enterprise. Cathode Copper produced by MICCL is registered with London Metal Exchange.

Refined Lead/ Refined Silver and Zinc Concentrates

Mining operations in Namtu Bawdwin lead/zinc mine started since the 15th century. The mine was operated by the Burma Mines Ltd prior to Myanmar's independence from British Colonial rule and became a joint venture operation in 1951. The mine is currently operating under No.1 Mining Enterprise. Other lead/zinc mines under No. 1 Mining Enterprise are Yadanatheingi and Bawsaing mines all of which are located in the Shan States. Bawdwin underground mine has its own concentrating plant for upgrading of sulphide ores of lead, where after the concentrates are fed into smelter at Namtu to produce refined lead and refined silver and zinc concentrates. By-products are copper matte, nickel speiss, antimonial lead. There are privately owned lead/zinc mines in the same region. Major share of lead/zinc production are exported. Silver and lead produced by the No.1 Mining Enterprise are also registered with London Metal Exchange.

Refined Tin, Tin Concentrate, Tin Wolfram mixed concentrates

Mawchi mine, located in Kayah State was well known for its tin tungsten scheelite mixed concentrate in the world market until most of the installations were destroyed during the Second World War. Tin and Tungsten mixed concentrates are also produced from various mines in Taninthayi division. Heinda Kanbauk and Kalonta tin mine are major tin producing mines. All tin and tungsten mines have been privatised and at present there is no state operated tin and tungsten mines except for one tin smelter in Thanlyin.

Coal

In the State Sector Kalewa underground coal mine and Namma opencast coal mine operate under No. 3 Mining Enterprise. In the private sector, Mawdaung opencast mine in Taninthayi division produces over 500,000 tonnes annually which are exported across the border to Thailand. Private owned coal mines in Shan State are operated by local entrepreneurs for local consumption. A 120 MW coalfired power plant is being built at Tigyt in the Shan State and coal production will increase significantly in the near future.

Gold

The Kyaukpahto gold mine located in the Kawlin township Sagaing division is operated by No.2 Mining Enterprise, while private gold mines in Mandalay division, Sagaing division and Kachin States operate with production sharing contracts signed between private mining companies and No.2 Mining Enterprise.

The government is working in joint venture with three foreign companies for exploration of gold, while another company is already at the production stage.

Iron and Steel

No.1 Iron and Steel Plant at Pyin Oo Lwin smelts iron ore from Kyatwinye iron mine located 26 miles to the South East of Pyin Oo Lwin. No.1 iron steel plant produces sponge iron, pig iron and steel, steel grinding balls and steel round bars. The products are used locally for construction works.

Limestone

Two types of limestone are produced in Myanmar depending on the physical properties. Limestone which has a high calcium content with no outstanding physical appearance is used as raw material

for cement production while limestone with inclusions giving rise to beautiful a texture and colour is used as decoration limestone, known as dimension stones. One of the outstanding decoration quality lime stone mine is situated near Loikaw. Limestone production is sufficient for the local cement industry.

c) Pearls

Pearls may be cultivated from either wild fished oysters or hatchery-produced shells. The Myanmar pearl industry has moved quickly to produce increasingly large quantities of pearls from hatcheries rather than from wild shells as in the old days. The British engaged in pearling for natural varieties in the Myeik Archipelago as early as 1891. The pearl industry was eventually nationalized under the socialist regime. In 1988 the government embraced a free market philosophy, and by 1996 foreign pearl companies began investing in Myanmar. The first was the Thai-owned Andaman Pearl Co.

In 1995 the Tasaki Co. signed a joint venture agreement with the government. After that The Myanmar Atlantic Pearl Co., based in Australia, in 1998; signed a joint venture agreement with the Myanmar Pearl Enterprise to culture pearls in the Myeik Archipelago. The company specializes in the culture of South Sea pearls. There are many varieties of pearls in the world today, including black pearls, tiny akoya Japanese pearls and freshwater pearls from China and India. But of all these, South Sea pearls are most valued and fetch the highest price⁶⁴. The product sharing agreement give the government of Myanmar 25% of the pearls produced and then free to dispose of 75 % for the Australian company that can sell them locally or export them without paying any further taxes.

In Myanmar there are five (5) companies - Nino Pearl, Myanmar Andaman, Tasaki Shinju, Atlantic Pearl and Aung Kyaw Si Jewellery Co, Ltd-involved in the business of pearl production.

The sector is regulated by the government's Myanmar Pearl Enterprise under the Ministry of Mines. In 2011-2012 the country produced 513,936 pearls, the next year 549,773, followed by 627,096, and 712,584 pearls in 2014-2015. The largest buyers of Myanmar pearls are Japan, Hong Kong, and China⁶⁵.

3.3.3 Context of the Artisanal Mining sector in Myanmar

Artisanal Ruby Mining

Artisanal mining, particularly for gold, has long been a traditional livelihood activity for people in areas where gold is present in alluvial systems. The equipment used in this process is very modest, requiring only a bamboo tripod mounted gravity riffle table, wooden gold pan and basic digging equipment.

In the mid-1990s Myanmar opened up to admit private interests and tourists from the outside world. Gemstone and jade mining were slightly liberalised and expanded. The major ruby mining areas of today, include the Mogok Stone Tract, and Mong Hsu in Shan State, while jade and the rarer jadeite are primarily mined in the Kachin State around Hpakant.

The mines of Mogok, and sub-mines in the surrounding areas have produced many of the finest rubies in the world. In addition to rubies, the land yields sapphires, spinel, peridot, aquamarine and a variety of other semi-precious stones.

Some smaller ruby mining areas also became official sources in the 1990s at Nawarat (also called Pyinlon) and Namhsa in Shan State, Sagyin (near Mandalay), Thabeitkyn and Kathe along the Irrwaddy River West of Mogok, Namya, which is located in the Kachin State a few miles from Hpakant near the Chinese border, and others.

⁶⁴ <http://www.myanmargems.com/pearlproducers.htm>

⁶⁵ <https://www.mmbiztoday.com/articles/can-pearls-be-southern-myanmars-new-big-industry>

Artisanal Gold Mining

Since the mid 1990s artisanal mining carried out mainly by locals, has gradually been replaced by mechanised equipment. These include riverbed mining with bucket and suction dredges as well as hydraulic mining of river banks and large open cast and shaft mines. On land, more and more areas are being deforested in order to make way for mining and to build the necessary infrastructures. Together with the mining activities, the use of the mining agent mercury has increased. Methods of mining that disturb increasingly large areas of land are spreading, including employment of cyanide leaching, as the most easily accessible alluvial gold is depleted and deposits deeper in the ground and in hard rock are exploited.

There is very little available information about ASM of coloured gems or jade in Myanmar. ASM gold mining on the other hand remains extremely common in Myanmar, with hundreds of thousands of people thought to be involved across the country. It is known that historically ASM gemstone mining was common and practiced widely. However, the increase in larger scale mechanised gem production over the past few years, together with tighter government control of gem-producing areas, has left little room for informal subsistence miners to operate⁶⁶.

In May 2016 it was reported that following a visit to the area by the new minister for natural resources and environmental conservation, the government agreed to step up supervision of jade mining in Hpakant. The ministry is proposing that tailings/waste be discarded in old mine pits, and at the time of writing, discussions about this are continuing with the state government⁶⁷.

3.3.4 Main mining projects

Ongoing mining projects in Myanmar can be summarised in the table below:

Projects	Status (start-up year)	Location	Ore reserve
Modi Momi Gold	Operating	Yamethin Township	A survey of the concession estimates it holds more than 2.3m oz of gold, and refined gold production reached 52,600 oz from September 2011 to March 2015.
Long Keng zinc mine	Operating	Township of Lashio	The Long Keng zinc mine covers 8km ² of highly prospective ground and hosted two surface outcrops of high-grade smithsonite with a historical Inferred Resource of 170,000 tonnes at an average grade of 37 % Zinc for a total metal content of 63,000 tonnes. The ore is presently being processed at the Lashio Zinc refinery.
Monywa Copper Project	Operating	Letpadaung, Salingyi Township, Sagaing Region	0.1% Cu (Letpadaung deposit) and 0.15% Cu (three other deposits) cut-off grades. 0.43 g/t Au and 6 g/t Ag reported in early estimations. This may not be a genuine porphyry copper deposit, but a high-sulfidation Cu(Au) deposit. A porphyry copper may well lie below.
Tagaung Taung Nickel Deposit	Operating (2011)	Mandalay Region, Thabeikkyin Township,	It has been estimated at 40 million tons of lateritic nickel ore with an average content of 2.02 % Ni based on 1.40 % cut-off grade, in TagaungTaung area. Chromite is also associated with nickel silicate.
Kalewa Coal Mine	Operating	Sagaing Region, Kalewa Township, Thichchawk village west bank of Chindwin river.	New Energy and Industrial Technology Development Institute (NEDO) from Japan carried out check boring in limited area, approximately 5.5 square km (3.6km x 1.5 km) during 1999-2000 and estimated the in-situ ore reserves of 15.3 million tons for 9 feet, 6 feet and 4 feet coal seams. Ore reserves will be increased if more borings are carried out in the northern extension area. According to the feasibility study by UNIDO Mission, Mining method proposal was combination of Underground mining Longwall mining system and open cut mining. Estimated total production envisaged was 140,000 tons per mine annually for 2 mines.

⁶⁶ Source: Gemstone Sector Review, Emma Irwin – July 2016

⁶⁷ Source: Gemstone Sector Review, Emma Irwin – July 2016

Projects	Status (start-up year)	Location	Ore reserve
BophiVum Chromite Deposit	2013-2015 Operating	Chin State, Tidim Township	<ul style="list-style-type: none"> • Joint research project between DGSE and Korea Institute of Geoscience and Mineral Resources (KIGAM) • Irregular, Lenticular, Lenses, pockets. • Podiform type, disseminates, leopard textured, nodular, massive. • Demarcated 12 km² wide target area, drilled 6 drill holes totaling in 600 meters depth. • 15 primary chromite outcrops and 29 chromite float occurrences were observed. • Measured reserve - 7780 tons • Indicated reserve - 12080 tons • Average grade - Cr- 12.61 %, Ni- 0.41 %
TaungNgalTaung Limestone Exploration	May 2013 to Oct. 2013	Bago Region, Padaung Township	<ul style="list-style-type: none"> • DGSE exploration project. • Drilled 6 drill holes • Measured reserve 31.43 million ton with CaO- 45.26 %, MgO-1.68 %, SiO₂-13.53 % • Indicated reserve 2.01 million ton with CaO- 46.71%, MgO- 0.83%, SiO₂-9.9 %
Loi Tom Coal Exploration	Feb.2013 to Mar. 2014	Shan State (North), Tang Yan Township.	<ul style="list-style-type: none"> • DGSE exploration project • Drilled 10 drill holes (total depth 610 meters) • Measured reserve 0.07 million tons. • Indicated reserve 0.0056 million tons. • Coal rank - Lignite • Coal quality - F.C 4.48 % to 40.56 %, C.V 6690 - 10950 Btu/lb
Mawlaikgyi Chaung Coal Exploration	Nov. 2013 to Mar. 2014	Sagaing Region, Maw Laik Township,	<ul style="list-style-type: none"> • DGSE exploration project • Hand Drill 42 Nos. (Total depth 440 meters) • Measured reserve 0.37 million tons • Indicated reserve 1.5 million tons • Coal rank - Lignite to Subbituminous • Coal quality - F.C 23.77% -52.92%, C.V 6710 - 12520 Btu/Lb.
YatkansinTaung Graphite Exploration	Jun. 2013 to Mar. 2014	Mandalay Region Singu/ Madaya Township	<ul style="list-style-type: none"> • DGSE exploration project • 4 drill holes (Total depth 210 meters) • Measured reserve 0.249 million tons, • Indicated reserve 0.019 million tons • Average carbon content of graphite is 20 %

3.3.5 Legal framework

The mining sector is governed by:

- the Myanmar Mining Law (1994) and the Law amending the Myanmar Mining Law (2015);
- the Myanmar Mining Rules (1996);
- the Myanmar Investment Law (2016) (MIL);
- the Myanmar Investment Rules (2017);
- MIC Notifications;
- Notification No. 10/2017 (Designation of Development Zones);
- Notification No. 11/2017 (prescribed Investment Capital Amendments);
- Notification No. 13/2017 (Classification of Promoted Sectors);
- Notification No. 15/2017 (List of Restricted Investment Activities);
- the State-Owned Economic Enterprises Law (1989) (SEE Law);
- the Gemstone Law (1995) and the second amendment of the Gemstone Law (2016);
- the Myanmar Pearl Law (1995);
- the Environmental Conservation Law (2012);
- the Law amending the Myanmar Pearl Law (2014).

MONREC is principally responsible for administering mining and the Myanmar Investment Commission (MIC) oversees the MIL.

On 24 December 2015 Myanmar's parliament (the Pyidaungsu Hluttaw) passed Law No. 72 'An Act Amending the Myanmar Mining Law' (2015 Mines Law). The 2015 Mines Law amends Myanmar's outdated 1994 Mines Law. The main changes introduced by this amendment are detailed in Section 3.3.11 of the report.

On 29 January 2016 Myanmar's parliament (the Pyidaungsu Hluttaw) passed the second amendment to the Myanmar Gemstone Law (23/2016). The main changes introduced by this amendment are detailed in Section 3.3.11 of the report.

Currently, there is no formal written mineral policy that would be comparable to the GOUM Energy Policy. However, MONREC has a "policy direction"⁶⁸. This policy direction sets out the government's overall privatisation goals, which are to encourage private sector investment into the mining sector and to avoid reliance on public sector funds. It is the policy of the Ministry of Mines not to make new investment on its own, but to encourage foreign and local investors to invest in the mining sector.

Any application for the award of a mining permit is subject to the signing of a production sharing or profit sharing agreements with MONREC. The types of agreement may be generally on production sharing basis or profit-sharing basis, depending on equity contribution by both parties. Production sharing type of investment could either be straight split on total production or after cost recovery. The Ministry of Mines is flexible whether to have majority, minority or equal participation in equity participation joint ventures, depending on a case by case basis.

MONREC can enter into agreements with mining operators through joint ventures with state owned enterprises (Mining Enterprise 1, 2 or 3 etc.) on a production sharing basis. However, these joint ventures only happen for the most significant large-scale projects.

⁶⁸ http://www.mining.gov.mm/Minister_Office/3.Minister_Office/details.asp?submenuID=4&sid=59

3.3.6 Institutional framework

Mining sector

According to Myanmar Mining Law, all naturally occurring minerals found either on or under the soil of any land in the continental shelf are deemed to be owned by the State.

MONREC (formerly Ministry of Mines) regulates the mining sector. Under the former government, ruling until 30 March 2016, the Ministry of Mines comprised six enterprises and two departments as follows:

Department of Geological Survey and Mineral Exploration (DGSE)	DGSME is responsible for countrywide geological mapping, mineral prospecting and exploration using geological, geochemical, geophysical and exploratory drilling techniques.
The Department of Mines	The Department of Mines is responsible for administration of mineral policies and planning mineral legislations, mine inspections and safety, minerals conservation and environmental conservation. The Mining Law 1994 specifies responsibility for monitoring of all explorations and mining permits residing in the Ministry of Mines. Under the Myanmar Mining Law, the Director General is the Chief Inspector of Mines and also responsible for scrutinising applications and granting of permits.
The Mining Enterprises⁶⁹:	
The State-Owned No. 1 Mining Enterprise	100% SOE responsible for mining, production and marketing of antimony, lead, zinc, silver, iron, nickel and copper ores.
The state-owned No. 2 Mining Enterprise	100% SOE responsible for mining, production and marketing of gold, platinum, tin, tungsten, molybdenum, niobium, columbium, heavy minerals and gold ores.
The state-owned No. 3 Mining Enterprise	100% SOE responsible for the production and supply of industrial raw minerals such as bauxite, bentonite, gypsum, limestone, dolomite, clay, manganese and coals.
Myanmar Gem Enterprise (MGE)	100% SOE responsible for mining and marketing of various precious gemstones and Jade.
Myanmar Pearl Enterprise (MPE)	100% SOE responsible for handling breeding and cultivating of mothers of Pearl, and Pearl production.
Myanmar Salt and Marine Chemical Enterprise (MSMCE)	100% SOE responsible for production and marketing of common salt, marine chemical and soda ash.

Graphic 10: Ministry of Mines Organisational Structure (now called MONREC)

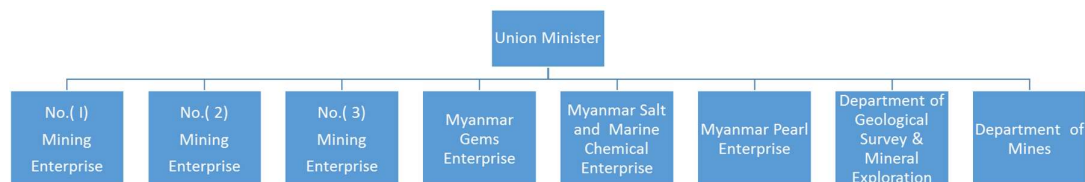

In March 2016, it was announced that the Ministry of Mines and the Ministry of Environmental Conservation and Forestry (MOECAF) would be merged into one ministry with the new incoming government. Since the merger, the ministry is called the Ministry of Natural Resources and Environmental Conservation (MONREC).

⁶⁹ According to the Myanmar Mines Law, 1994

MONREC comprises three departments, namely Union Minister's Office, the Department of Mines (DOM), Department of Geological Survey and Mineral Explorer, and four enterprises, namely No. 1 Mining Enterprise, No. 2 Mining Enterprise, Myanmar Gems Enterprise and Myanmar Pearl Enterprise.

The Ministry evaluates and processes all licence applications for the prospection and production of minerals (value added processing) in accordance with the 1994 Mining Law. It also monitors production operations and promotes investment in the minerals sector.

State Enterprises rely on a production sharing contract (PSC) system with private companies, by which 100% of the investments are borne privately and profits are shared between the two parties⁷⁰. According to GOUM officials, all mines are now either JVs or have been privatised and State Enterprises are no longer involved in the mining operations.

Gemstone sector case

In addition to the Ministry of Mines (now under MONREC), the main government institutions and stakeholders relevant to the gemstone sector are:

- Myanmar Gems Enterprise;
- Leading Committee for Myanmar Gems Sector Development;
- The Valuation Committee;
- The Central Gemstone Supervisory Committee (Central Committee);
- Myanmar Gems and Jewellery Entrepreneurs Association (MGJEA);
- Gems Trading Centre/One Stop Shop; and
- Myanmar Gems and Minerals Development Bank.

Myanmar Gems Enterprise (MGE)

MGE is responsible for all functions relating to gemstones, including permitting, licensing, the regulatory framework, production/joint venture production partnerships with private companies, collection of royalties, production monitoring, oversight and marketing of jade and gemstones in Myanmar. MGE is also responsible for the Gems Emporiums. In 2015 one main international emporium, and one smaller local emporium were held in Nay Pyi Taw.

MGE's main roles are⁷¹:

- participating in Joint Venture on behalf of the State;
- design of blocks at the tract areas;
- issue production permits to national entrepreneurs and cooperative societies;
- impose taxes under the Mines Law and Gemstone Law for Gems and Jade production or for the sale of rough and finished products; and
- organise the Emporium under the supervision of MONREC

MGE's head office is located in Nay Pyi Taw at the Gems Museum, and it also has offices in Yangon, in Mogok and in Hpakant, each managed by an MGE Director (4 Directors in total) as shown in the organisation chart below:

⁷⁰ The average PSC provides 30% of profits for the government and 70% for the private contractor. Besides the PSC, there is a 3% royalty levy, a 5% commercial tax, and a 2% income tax.

⁷¹ MONREC website

Graphic 11: MGE Organisational Structure

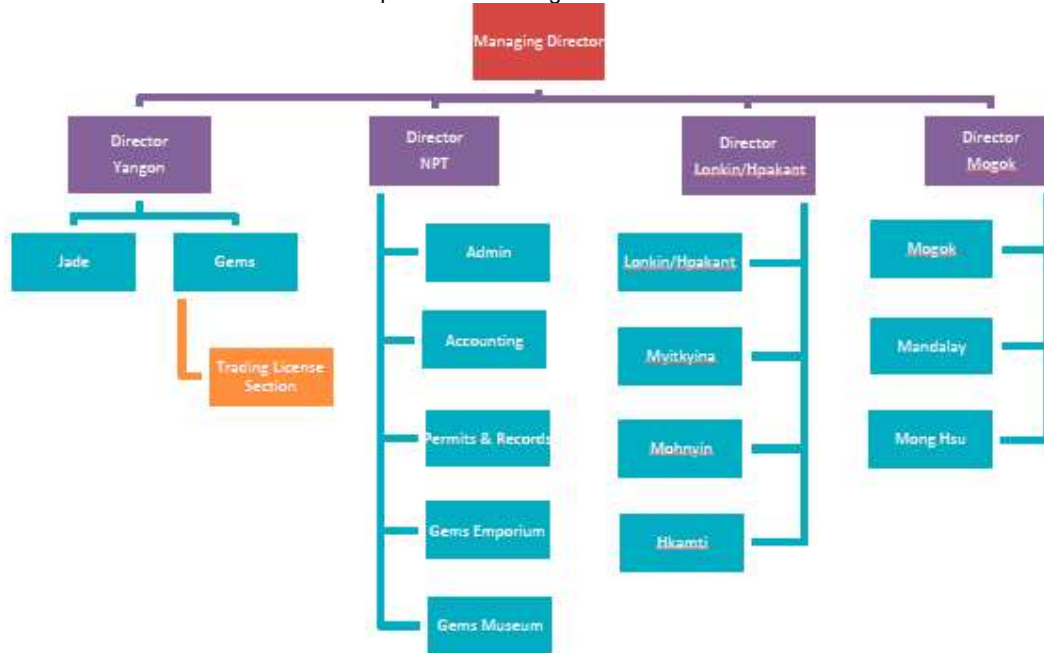

Leading Committee for Myanmar Gems Sector Development

The Leading Committee for Myanmar Gems Sector Development (Leading Committee) is the highest level and most powerful decision-making body for the gemstone sector in government. It has ultimate oversight and decision-making power over all gemstone related matters in Myanmar, from the approval of gemstone production permits to gemstone valuation. It has been composed of the followings:

- Minister of Mines (Chairman);
- Deputy Minister of Mines;
- Deputy Minister of Home Affairs;
- Deputy Minister of Finance;
- Deputy Minister of National Planning and Economic Development;
- Deputy Attorney General;
- Director General (DG) Directorate of Water Resources and Irrigation;
- DG Department of Forestry; and
- DG Department of Mines.

The Valuation Committee

The Local Valuation Committee is responsible for the evaluation of the products being declared. This committee meets at the regional MGE office on a weekly basis. The product is assessed and its value is determined. The royalty on production is-determined according to the evaluation of the Local Valuation Committee.

The Local Valuation Committee comprises representatives from MGE, the Gems and Jade companies, an external gems expert and representatives from other relevant Government Agencies (IRD, Customs). The chairman of this committee is an MGE officer.

Myanmar Gems and Jewellery Entrepreneurs Association (MGJEA)

The Myanmar Gems and Jewellery Entrepreneurs Association (MGJEA) is the main association for the gemstone sector. It has 10,000 members, 65% of whom represent the jade sub-sector while 35% represent coloured stones. Members include all gemstone permit and license holders. MGJEA collaborates closely with MGE and plays a central role in the annual Gems Emporium and other trading forums⁷².

MGJEA plays a very important role at the Gems Emporium, supporting government and monitoring the Emporium. The Gems Emporium Central Committee is comprised mostly of MGJEA members but also includes some government members. MGJEA is responsible for sending invitations to the Emporium and ensures government representatives are invited.

MGJEA also plays an important role in valuation at the Emporium, and also forms part of the Central Gemstone Supervisory Committee (which is also the main valuation body). MGJEA also intervenes when disputes relating to valuation arise at the Emporium. After a reserve price for auction has been set, and one day before the Emporium commences, MGJEA has an opportunity to check the agreed value one last time and to ensure the valuation is correct.

Gems Trading Centre/One Stop Shop

MGE has set up Gems Trading Centres in Mandalay, Myitkyina and Sagaing, and in early 2016 a Gems Trading Centre was also set up in Nay Pyi Taw, where trade in rough stones was allowed officially. These are managed by MGE together with MGJEA.

Market prices at the trading centres are set, making the trading centres more attractive to most traders, miners and buyers. MGE, MGJEA, Department of Customs, mining companies and traders are all under one roof together, and, in theory, the trading centres help support the legitimisation of the gems markets by ensuring that all involved have the correct paperwork and adhere to the agreed procedures, and therefore are in everybody's interest.

Myanmar Gems and Minerals Development Bank

The Gems and Minerals Development Bank received a formal banking licence in February 2016. The bank set up by MGJEA members with the aim of funding both small and large businesses in the gem industries, as well as helping entrepreneurs with business development projects. The bank is based in Yangon with branches in Mandalay, Mogok, Sagaing, Hpakant and Myitkyina.

3.3.7 Types of Mining permits

An organisation that wishes to carry out prospecting, exploration, large scale production or small-scale production activities in relation to gemstones, metallic minerals, industrial minerals or stones, must apply for a permit.

Different permits are issued by MONREC, depending on the type of activities, or on whether or not foreigners are involved, and each permit will specify the conditions and restrictions that the applicant is required to comply with.

The Mining Rules 1996, and the law amending the Myanmar Mining Law 2015, provide for the issue of prospecting permits, exploration permits, small, medium and large-scale mineral production permits, subsistence mineral production permits and integrated permits for prospecting, exploration and production.

⁷² Source: Gemstone Sector Review – July 2016

The mining legislation specifies six types of permits that can be issued (prospecting permits, exploration permits, large scale production permits, small scale production permits, subsistence production permits and an integrated permits).

Permit Type	Definition	Validity period
Prospecting permit	This is issued to a person or organisation desirous of carrying out prospecting operations of metallic minerals, industrial minerals or stones The total area of land for which the permit is attributed must not exceed 4,200 km ²	Period not exceeding 1 year
Mineral Exploration Permit	This is issued to a person or an organisation desirous of carrying out exploration of metallic minerals, industrial minerals or stones. The total area of land for which the permit is attributed must not exceed 3,150 km ²	Period not exceeding 3 years.
Large Scale Mineral Production Permit	This is issued to a person or an organisation desirous of carrying out large scale production of metallic minerals, industrial minerals or stones.	Period not exceeding 25 years
Small Scale Mineral Production Permit	This is issued to a person or an organisation desirous of carrying out small scale production operation of metallic minerals, industrial minerals or stones. The total area of land for which the permit is attributed must not exceed 1 km ²	Period not exceeding 5 years (with possible extension for 1 year)
Subsistence Mineral Production Permit	This is issued to a person desirous of carrying out subsistence mineral production operation of metallic minerals, industrial minerals or stones.	Period not exceeding 1 year
Integrated Permit	This is issued to a person or an organisation desirous of obtaining an integrated permit for more than one operations out of the three operations of mineral prospecting, mineral exploration, large scale production or small-scale production of metallic mineral, industrial mineral or stones involving foreign or local investment.	

The law amending the Myanmar Mining Law added a provision to issue a permit to conduct a feasibility study, value-added process and sale and purchase permit.

Gemstone sector

According to the Myanmar Gemstone Law, there are two types of gemstone license in Myanmar:

- Gemstone production permit (for exploration, production, trading, processing and retail); and
- Gemstone trading license (for trading, processing and retail).

The 2016 amendments to the 1995 Gemstone Law allow for 4 kinds of permit:

- Large scale extraction and production permit - 10 years;
- Medium scale extraction and production permit– 5 years;
- Small scale extraction and production permit– 3 years; and
- Very small scale (or subsistence) extraction and production permit – 1 year

3.3.8 Contract types

The Mines Rules allow MOM to enter into agreements for prospection, exploration or production with mining operators and to set up joint-ventures between mining state-owned enterprises and operators (Rules 83 and 84). MOM can enter into such contracts on a production-sharing basis or profit-sharing basis (Rule 85).

Once a license application is approved, the investor is expected to negotiate and sign an agreement with the Department of Geological Survey and Mineral Exploration (in the case of prospecting, exploration, or feasibility study permits) or with the relevant mining enterprise (SOEs) (in the case of production permits).

Given the lack of strong legal framework and the large number of regulations, contracts play a key role in regulating company policies. In practice, mining is usually conducted under production sharing contracts (PSCs), which are not mentioned in the Mining Rules 1996.

A profit-sharing arrangement is primarily used for current projects with active mines and plants. Parties may enter into a joint venture with a state-owned enterprise through competitive bidding or by entering into an agreement based on negotiated terms by both parties.

Under the current model of PSC, MoNREC provides two years for prospection. An exploration permit is granted for no more than three years with a one-year extension available upon submitting an application for extension. A production permit is generally granted for 25 years with four extensions of five years each. There are substantial delays in the issue of permits, compounded by complications by land acquisition problems.

The sharing of production costs may be fixed for the term of the agreement or on a sliding scale depending on the level of production. The government's share of production can be inclusive of royalties, valued upon a mutually agreed price, and sold back to the investor.

MONREC currently favours PSCs over joint venture agreements. A PSC is a straight split on total production. Alternatively, there can be a cost-recovery type of production sharing, where a certain percentage of total revenue is reserved for recovery of the production costs. A straight split of the total production is preferred in large-volume, low-price and low cost-of-production minerals, such as dimension stones, coal and other industrial minerals. For more valuable metallic minerals such as gold and copper, production sharing with cost recovery is preferred.

Gemstone sector case

The 1995 Gemstone Law does not provide for joint venture profit sharing arrangements, whereas the 2016 amendment does. In practice however, JV arrangements have been happening for some years. The legal basis for the joint venture system was until 2015 an agreement between MGE (40%) and the private operator (60%), and the split was based on the actual sale value of gemstone produced.

In June 2015 at the 52nd Gems Emporium in Nay Pyi Taw, it was agreed that the JV system would change from a 40%/60% production share split, to 25%/75%. All existing JV arrangements were amended during the Gems Emporium, so that since then all current JV permits are now split 25% MGE and 75% private company of the sale value of gemstones produced. At the time of writing in April 2016, no new JV permits had been issued in 2015-16 according to the 25%/75% split.

According to the 2016 amendments to the 1995 Gemstone Law it appears that all large-scale or medium-scale permits will now be issued on a JV production-sharing basis with MGE.

3.3.9 Taxes and Fees Collected from mining companies

The main taxes and fees collected from mining companies are detailed as follows:

Royalty	The holder of a mineral production permit must pay royalties to the government according to the Myanmar Mining Law. The rates are as follows. <ul style="list-style-type: none"> • for gold, platinum, uranium and other precious metallic minerals the Ministry may, with the approval of the government, prescribe and publish by notification from time to time at the rate of 5%; • for silver, copper, tin, tungsten, nickel, heavy-earth, molybdenum, iridium, osmium, palladium, ruthenium, rhodium, tantalum, columbium, niobium, thorium, cadmium, rare earth element, beryllium, titanium and other precious metallic minerals the Ministry may, with the approval of the government, prescribe and publish by notification from time to time at the rate of 4%; • for iron, zinc, lead, antimony, aluminium, arsenic, bismuth, chromium, cobalt, manganese, magnesium and other precious metallic minerals the Ministry may, with the approval of the government, prescribe and publish by notification from time to time at the rate of 3 %; and • for industrial mineral or stone, at the rate of 2 %.
Dead rent	The holder of the permit shall pay dead rent for the land related to the permit in accordance with the rate specified. Dead rent shall be paid yearly in two instalments, which shall be at the rates mentioned in the Mining Law. The rates are subject to the types of operation and minerals.
Income tax	Income tax rates depend on whether the joint venture company is a 'resident' (ie, formed under Myanmar law) or a non-resident formed under a law other than Myanmar law, such as a 'branch office'. For resident companies, the income tax rate is 25 % of profits. For non-resident companies, the income tax rate has been set at 25 % since April 2015. For companies or individuals permitted and operating under MIL, and foreign

	organisations engaged by special permission in a state-sponsored project, enterprise or undertaking, the income tax is 25 %.
Commercial tax	Notification No. 117/2012, last amended in April 2015, prescribes commercial taxes of between 5 and 100 % depending upon the different goods and services businesses concerned. The application for registration must be in the prescribed form and filed one month before the commencement of business.
Stamp duties	Stamp duties collected from the sale of judicial and non-judicial stamps represent fees payable under the Court Fees Act. Non-judicial stamp duty is levied on various types of instruments required to be stamped under the Myanmar Stamp Act.

No tax stabilisation agreements are in force in Myanmar. However, MIL allows the Myanmar Investment Commission to grant exemptions from income tax including:

- exemption or relief from income tax if the profit realised by the company has obtained a permit or an endorsement that such profit will be reinvested in the same business or in any similar type of investment business within one year;
- right to depreciation for the purpose of income tax assessment, after computing such depreciation from the year of commencement of commercial operation based on a depreciation rate which is less than the stipulated lifetime of the machinery, equipment, building or capital assets used in the investment; and
- right to deduct expenses which are incurred for the research and development relating to the investment businesses carried out within the Union and actually required for the economic development of the Union from the assessable income.

3.3.10 State participation in the mining sector

State Owned Enterprises (SOEs)

The State-owned Economic Enterprise Law grants the government discretion to allow investment either as joint-venture between the government and the investor, or to allow the investor to pursue the enterprise independently under prescribed conditions.

Where the relevant Ministry considers that the application should be dealt with under Foreign Investment Law, the company will be required to obtain a Foreign Investment Law permit instead. Factors which suggest that Foreign Investment Law is applicable include: whether the Ministry believes the operation should be a joint venture with a State-Owned Enterprise and the size of the proposed operation.

Joint venture companies which partner with the State or a State Owned Enterprise must obtain a Foreign Investment Law permit along with a Companies Act permit. Foreign Investment Law permits are issued by the Myanmar Investment Commission (MIC). For joint-ventures, MIC has discretion to stipulate minimum equity participation requirements for each partner.

As is discussed in Section 3.2.10, all the mining SOEs appear to play a central role in the allocation of licenses, collection of revenues and management of local content, all of which are crucial determinants of how the state benefits from mineral activities. But these companies do not provide up to date information even on the list of joint ventures they participate in, much less their revenues, expenditures, or relationships with sub-contractors.

Unlike MOGE, the mining-sector SOEs do not exercise formal de jure power to award permits to large-scale and small-scale commercial mining projects. This power is vested in MONREC. Article 6 of the Mines Law of 1994 stipulates that a person or company seeking to engage in subsistence production of minerals (including gemstones) “shall apply to the relevant Mining Enterprise or to the officer authorised by the Ministry” for a permit. Article 10, in turn, empowers the “respective Mining Enterprise or the officer authorised by the Ministry” to issue such a permit. The term “subsistence” under this law is limited to production using “ordinary hand tools.”

We also understand that the mining-sector SOEs do not play a formal role in the process of overseeing compliance by commercial companies with the country’s laws or the execution of their work plans. In their roles chairing the Joint Management Committees for each project, however, SOEs are able to exercise influence on the execution of the projects.

As with the Oil and Gas sector, the mining-sector SOEs represent a key player as a recipient of revenues resulting from mining contracts provisions. The Mines Law, Mining Rules and Gemstone Law similarly to oil and gas legislation lack any explicit rules on the functioning of the SOEs or their reporting structure vis-à-vis government ministries. As shown in Table 21, the EITI figures for the year 2014-2015 indicate that upstream SOEs under MONREC taken together deposited approximately USD 167.41 million (166.61 billion kyat) into its Other Accounts.

Table 21: Transfers by mining sector SOEs into "Other Accounts," 2014 - 2015

	Transfer to Other Accounts, million MMK	Transfer to Other Accounts, million USD
MGE	112,394	112.93
ME1	4,365	4.39
ME2	22,319	22.43
ME3	27,534	27.67
Total	166,612	167.41

As agreed by MSG, SOEs were requested to disclose their level of beneficial ownership in mining, oil and gas companies operating within the extractive sector, including those held by SOE subsidiaries and joint ventures, and any changes in the level of ownership during the reporting period.

Participation of MGE in the Gems and Jade Joint Ventures

In 2014-2015, MGE held 40% in all the Gems and Jade JVs. The list of Gems and Jade Joint Ventures is presented in the Appendix 10 of the report.

We understood that MGE did not hold any participation in the equity of mining companies in 2015-2016. Furthermore, we understood that there were no transfers of licences between 2014-2015 and 2015-2016.

Participation of ME1 and ME3 in the mining Joint Ventures

According to the data provided by ME1 and ME3 the following rules are followed for the participation in the mining Joint Ventures:

- **For Lead, Zinc, Antimony, Iron, Chromium, Manganese Dioxide:** 3% royalties are levied on the extracted products. The remaining minerals are split between ME1 (30%) and the contractor (70%);

Extracted Products	Royalties	Remaining Minerals
100%	3%	97%
Remaining Minerals	ME1	Contractor
100%	30%	70%

- **For Copper and Nickel:** 4% royalties are levied on the extracted products. The remaining minerals are split between ME1 (30%) and the contractor (70%);

Extracted Products	Royalties	Remaining Minerals
100%	4%	96%
Remaining Minerals	ME1	Contractor
100%	30%	70%

- **For coal and limestone:** 2% royalties are levied on the extracted products. The remaining minerals are split between ME1 (30%) and the contractor (70%);

Extracted Products	Royalties	Remaining Minerals
100%	2%	98%
Remaining Minerals	ME1	Contractor
100%	30%	70%

- **GPS Joint Venture Co., Ltd case** (production of lead): royalties are levied on the extracted products. The remaining minerals are split between ME1 and the contractor as follows:

If the refined lead LME price is lower than USD 3,000 per ton		
Remaining Minerals	ME1	Contractor
100%	13.5%	86.5%
If the refined lead LME price is above USD 3,000 and less USD 4,000		
Remaining Minerals	ME1	Contractor
100%	20.0%	80.0%
If the refined lead LME price is above USD 4,000 per ton		
Remaining Minerals	ME1	Contractor
100%	28.0%	72.0%

- **Simco Song Da Joint Company case** (production of marble): The extracted minerals are split between ME1 and the contractor as follows:

If the price of marble per cubic meter (F.O.B) is below USD 649		
Remaining Minerals	ME3	Contractor
100%	20.0%	80.0%
If the price of marble per cubic meter (F.O.B) is between USD 650 to USD 749		
Remaining Minerals	ME3	Contractor
100%	25.0%	75.0%
If the price of marble per cubic meter (F.O.B) is above USD 750		
Remaining Minerals	ME3	Contractor
100%	30.0%	70.0%

- **Tagaung Taung Nickel project case (CNMC Nickel Company Ltd)** (production of Nickel):

If the price of Nickel LME is USD 15,000 and below		
Remaining Minerals	ME1	Contractor
100%	1.0%	99.0%
If the price of Nickel LME is between USD 15,001 and USD 20,000		
Remaining Minerals	ME1	Contractor
100%	50.0%	50.0%
If the price of Nickel LME is between USD 20,001 and USD 25,000		
Remaining Minerals	ME1	Contractor
100%	12.00%	88.00%
If the price of Nickel LME is between USD 25,001 and USD 29,000		
Remaining Minerals	ME1	Contractor
100%	15.75%	84.25%
If the price of Nickel LME is between USD 29,001 and USD 35,000		
Remaining Minerals	ME1	Contractor
100%	20.00%	80.00%
If the price of Nickel LME is between USD 35,001 and USD 42,000		
Remaining Minerals	ME1	Contractor
100%	23.75%	76.25%
If the price of Nickel LME is between USD 42,001 and USD 50,000		
Remaining Minerals	ME1	Contractor
100%	28.00%	72.00%
If the price of Nickel LME is USD 50,001 and above		
Remaining Minerals	ME1	Contractor
100%	32.00%	68.00%

The list of mining Joint Ventures is presented in the Appendix 10 of the report. We understood that ME1 and ME3 did not hold any participation in the equity of mining companies in 2014-2015. Furthermore, we understood that there were no transfers of licences neither changes in the percentages detained in the JVs between 2013-2014 and 2014-2015.

Participation of ME2 in the mining Joint Ventures

The participation of ME2 in the mining Joint Ventures is presented in the Appendix 21 of the report. We understood that ME2 did not hold any participation in the equity of mining companies in 2014-2015. Furthermore, we understood that there were no transfers of licences neither changes in the percentages detained in the JVs between 2013-2014 and 2014-2015.

Military Holding Companies

The two large military holdings companies, Union of Myanmar Economic Holdings (UMEHL) and (Myanmar Economic Corporation) MEC hold important positions in Myanmar's economy, including in the energy, mining and gems sectors. These two companies which report to directorates of the Defence Services are set up under laws that provide protections and privileges to state-based companies.

We understand that the activities of the two military associated companies are not included in the budget data. These companies are not considered as SOEs under Myanmar law. They are private companies which many believe are largely owned and managed by military officers and other public officials.

The purpose for setting up both companies was to generate funds for the welfare of both active-duty and retired Defence Services personnel and their families. This has been achieved through a combination of profit distribution and job provision for family members of military personnel as well as for veterans themselves.

Myanmar Economic Holdings Limited (UMEHL)

UMEHL was set up in 1990 under the Special Companies Act as the economic arm of the Burmese military, during a period of privatisation and transition from a socialist command economy, with an initial capital of USD 1.6 billion. Its objective was to generate profits from light industry and the trade in commercial goods.

In the mid-2000s it expanded into services and trading activities. Its current holdings include stakes in almost all sectors of the Myanmar economy.

UMEHL is jointly owned by two military departments; 40% of shares are owned by the Directorate of Defence Procurement while 60% of shares are owned by active and veteran defence personnel, including high-ranking military officials of the former ruling military junta, the State Peace and Development Council (SPDC) and veterans organisations.⁷³

UMEHL has monopoly on the country's gems sector and also holds a significant portfolio in various industries including banking, tourism, real estate, transportation, and metals.⁷⁴ With its affiliation to the Burmese military, which ruled the country for almost 50 years, UMEHL has exclusive access to secure preferential contracts with foreign firms.⁷⁵ Most FDI in Burma is done through joint ventures with UMEHL.

UMEHL classifies its holdings into three categories: fully-owned and-operated, affiliate subsidiaries and joint ventures. Fully-owned UMEHL companies have significant roles in extractives industries. Its subsidiaries include Myanmar Imperial Jade Company and Myanmar Ruby Enterprise, which operates mines at Mogoke, Mongshu, Nayar, Mawchi and Thabeikkyin. Some of these operations are subcontracted to other domestic companies. In spite of their apparent importance within the

⁷³ Win Min, "Burmese Military Government: Crony Capitalism in Uniform," *Virginia Review of Asian Studies* 6 (2004): 27 - 41.

⁷⁴ Callahan, Mary P. (2005). *Making Enemies: War And State Building in Burma*. Cornell University Press.

⁷⁵ Fujita, Kōichi; Fumiharu Mieno; Ikuko Okamoto (2009). *The Economic Transition in Myanmar After 1988: Market Economy Versus State Control*. NUS Press

extractive industries, [very little up to date information on the roles, performance, holdings or revenues of UMEHL is available](#).

Control or shareholding in other companies with strong links to the extractive sector is set out as follows:

Table 22: UMEHL mining interests (non-exhaustive)

Companies ⁷⁶	% of interest ⁷⁷
Myanmar Ruby Enterprises	N/C
Myanmar Imperial Jade Company Ltd	100%
Myanmar Rubber Wood Company Ltd.	N/C
Yadana Kadeikada Company Ltd.	N/C
Myanmar Jade International Ltd.	N/C
MG Ruby Company Ltd.	N/C
Myanmar Posko Steel Company Ltd.	N/C
Myanmar Nouveau Steel Company Ltd.	N/C
Myanmar Daewoo International Ltd	N/C
Kayar Mine Production Co., Ltd	100%

The Myanmar Economic Corporation (MEC)

MEC was set up in 1997, during the Asian financial crisis. MEC is one of the two major holding companies operated by the Burmese military forces. Founded in 1997 to set up profitable heavy industries that can provide the Burmese military access to supplies of important materials (e.g. cement and rubber).

MEC is operated under the Ministry of Defence's Directorate of Defence Procurement (DPP), with its private shares exclusively owned by active-duty military personnel.⁷⁸ The corporation's capital was issued through revenues generated from the public auctioning of State-Owned Enterprises throughout the 1990s. Through joint ventures with foreign companies and mergers with smaller companies, MEC has positioned itself as one of Burma's largest corporations.

Along with UMEHL, MEC is widely observed to generate most of the Burmese military's operating revenue, which are not held accountable to the Burmese parliament.⁷⁹ Although less is publicly known about MEC than UMEHL, OAG has the power to request audits from MEC but not from UMEHL.

MEC was selected in the EITI scope and was asked to report its legal and beneficial ownership as well as its level of ownership in mining companies operating in Myanmar. However, MEC has failed to provide any of the requested information. MEC's website⁸⁰ pledges the company's support for economic development, higher living standards and the eradication of poverty in Myanmar. Nevertheless, we note that according to MEC's website, the companies operates in strategic sectors ranging from manufacturing to telecommunication; but there is no indication that MEC holds interests in the mining sector.

According to MEC's EITI reporting, it sold gems and jade worth EUR 5,974,580 in 2014-2015. The total payment made to the government during the same period amount to Kyat 828,962,660.

3.3.11 Financial relationship between mining SOEs and the State

The financial relationship between mining sector SOEs and the State is the same as that governing the relationship with MOGE. The rules governing the relationship were included and presented in Section 3.2.11 of this report.

⁷⁶ Gilded Gatekeepers: Myanmar's State-Owned Oil, Gas and Mining Enterprises, NRGI, 2016.

⁷⁷ % of ownership as reported by companies selected in the EITI scope

⁷⁸ Singh, Ravi Shekhar Narain (2005). *Asian Strategic And Military Perspective*. Lancer Publishers. p. 209.

⁷⁹ "Junta stocking up on weapons for rainy day: observer". *Mizzma*. 24 December 2009. Retrieved 3 October 2012.

⁸⁰ <http://www.mecwebsite.com/>

In 2014/2015, the amounts retained by mining sector SOEs after the payment of transfers to the central government were 71% and 3% of total mining revenues and public expenditure respectively. Mining sector SOE's deposited approximately \$560 billion (557 billion kyat) into its "Other Accounts". The detail of revenues collected and transferred by mining SOEs and the balance of their respective Other Accounts are shown in the succeeding.

Table 22: SEEs "Other Accounts," as at 31 March 2015, per EITI report

MGE	
	Amount (in million MMK)
Opening balance as at 1 April 2014	416,864
Add: Total Received Amount	250,433
Trading Income	124,558
Income by Myanmar Gems Law	87,449
Sales Commission	30,900
General Income	7,526
Cash return by 2013-14 fiscal year	0.4
Less: Total Expenditure Amount	(138,038)
Purchases	(498)
Cash Refund	(1)
Income Tax	(75,712)
State Contribution	(61,495)
Input in to SEE Account	(332)
Closing balance as at 31 March 2015	529,259

Source: MGE

ME1	
	Amount (in million MMK)
Opening balance as at 1 April 2014	13,470
Add: Total Received Amount	4,885
Production Split	3,895
Application Fees	255
Sale	708
Other	38
Less: Total Expenditure Amount	(519)
State Contribution	(334)
Income Tax	(254)
Other	(32)
Closing balance as at 31 March 2015	17,836

Source: ME1

ME2	
	Amount (in million MMK)
Opening balance as at 1 April 2014	50,054
Add: Total Received Amount	32,359
Gold and Mineral Sale	30,391
Signature (Application Fee)	955
Other Income J.V	828
A/c transfer	185
Less: Total Expenditure Amount	(10,040)
State Contribution	(5,346)
Income Tax	(4,230)
A/c transfer	(322)
Raw materials	(87)
Petrol, Oil and Lubricants	(54)
Closing balance as at 31 March 2015	72,374

Source: ME2

ME3	
	Amount (in million MMK)
Opening balance as at 1 April 2014	8,373
Add: Total Received Amount	29,255
Production Split	27,975
Application Fees	221
Rent	932
Other	128
Less: Total Expenditure Amount	(1,721)
State Contribution	(723)
Income Tax	(904)
Other	(94)
Closing balance as at 31 March 2015	35,908

Source: ME3

MPE	
	Amount (in million MMK)
Opening balance as at 1 April 2014	10,319
Add: Total Received Amount	11,529
Sales of Pearl	10,879
Sales of Shell	483
Other income	167
Less: Total Expenditure Amount	(4,752)
Raw Material	(431)
Income Tax	(1,066)
Contribution	(853)
Purchase of Treasury Bill (24 Nos)	(2,400)
Advance of T-Bill Services (10%)	(2)
Audit Objection	(0)
Closing balance as at 31 March 2015	17,095

Source: ME3

Mining SOEs statements of total revenues and expenditures for the year 2014/2015 are as follows:

Table 23: SOEs total revenues and expenditures in FY 2014-2015

MGE

	In million MMK			
	Current	Capital	Financial	Total
Revenues	262,067	-	-	262,067
Expenditures	(142,141)	(107)	-	(142,249)
Total	119,926	(107)	-	119,818

Source: MoPF

ME1

	In million MMK			
	Current	Capital	Financial	Total
Revenues	4,995	112	-	5,107
Expenditures	(5,996)	(12)	-	(6,008)
Total	(1,001)	100	-	(901)

Source: MoPF

ME2

	In million MMK			
	Current	Capital	Financial	Total
Revenues	32,433	3		32,436
Expenditures	(21,605)	(36)		(21,641)
Total	10,828	(33)	-	(10,795)

Source: ME2

ME3

	In million MMK			
	Current	Capital	Financial	Total
Revenues	29,321	0	-	29,321
Expenditures	(3,132)	(14)	-	(3,147)
Total	26,188	(14)	-	26,174

Source: MoPF

Payments received, and transfers made by mining SOEs during the fiscal year 2014-2015 are summarised as followings:

Contractual and fiscal information	MGE	ME 1	ME2	ME3
Total payments made to the government	144,650	4,022	14,180	1,627
<i>Transfers to the government</i>	83,155	2,162	8,834	904
<i>State contribution declaration</i>	61,495	1,860	5,346	723
Transfer of funds, earnings, reinvestment, and third-party financing	None	None	None	None
Payments made to finance/ fund social services, public infrastructure, fuel subsidies and national debt	None	None	None	None
Loans/borrowings extended from the national government or department agencies	None	None	None	None
Loans or loan guarantees to mining, oil and gas companies operating within the country	None	None	None	None
Quasi-fiscal expenditures	None	None	None	None

3.3.12 Policy on disclosure of contracts and licenses**Contracts disclosures**

Contract terms in mining sector remain largely unknown, thanks to confidentiality clauses included in most mining agreements. Companies inform us that under existing contractual terms they are unable to disclose contracts without government consent, even where they are willing to do so.

We understand that the main type of model contract between mining operators and mining enterprises includes a confidentiality clause which prevents the parties not to disclose any information relating to the Operations to third parties, except for information which is required to be

disclosed by law to financial institutions for the purpose of funding. However, that clause does not expressly prohibit disclosure of the contracts themselves. Moreover, the mining legislation does not include any specific restrictions on the public disclosure of contracts and licenses by the government.

The Department of Geological Survey and Mineral Exploration has since made public and updated a sample agreement for prospection, exploration and feasibility study operations.⁸¹ The agreement includes information on fiscal terms and operational commitments. It also outlines the companies' administrative and legal responsibilities and the formation of a joint coordination committee for oversight of mining operations.

Contract allocation and transfer disclosure

The Mining Legislation does not restrict the disclosure of the award or transfer of mining permits or the criteria used for the granting of a licence.

In practice, MONREC does not publicly release any information on the award or transfer of mining permits and there may be restrictions on disclosure of such information in mining contracts signed with operators.

3.3.13 Register of mining permits

The EITI Standard requires countries to maintain publicly available registers of extractive sector licences and concessions (EITI Requirement 2.3). The Mining Legislation does not prohibit the disclosure of licence information required by the EITI Standard.

However, there is presently no public register of mining permits/concessions in Myanmar and limited information is available on mining permit holders, permit areas and duration of the permits.

The Mining Enterprises under MONREC maintains a list of mining permits that includes the following information:

- Service Contract No;
- License holder;
- Type of license;
- Date of application (except for ME1, ME2 (small scale), ME3 and DoM);
- Date of award;
- Date of expiry;
- Commodity;
- Location;
- Area (in Km²); and
- Coordinates of license area (except for ME3 and MGE).

Similar to the observation on license register in oil and gas sector, the list is not publicly available and had to be obtained directly from the Mining enterprises. As a result, MONREC is now working with support from international development partners to develop a mining cadastre, with a view to make key information publicly available online.⁸²

The list of the active licenses provided to us by MONREC is attached in Appendix 10 of the report.

⁸¹ Department of Geological Survey and Mineral Exploration, "[Sample] Agreement for prospecting, exploration and feasibility study of __ and associated minerals at __ area, __ township, __ region" (web date 2012) and Department of Geological Survey and Mineral Exploration, "[Sample] Agreement for prospecting, exploration and feasibility study of __ and associated minerals at __ area, __ township, __ region" (web date 2016).

⁸² https://eiti.org/sites/default/files/documents/cadastre_tor_phase_1.pdf

3.3.14 Award procedures for mineral concessions and licenses

Award procedures

The award of mining permits and licenses is governed by the Mining Rules 1996. There is a strict requirement that a person shall not prospect for minerals or carry on mining operations or mineral processing operations without the authority of a mining permit or mineral licence.

Mineral licenses are currently awarded on a first-come, first-served basis (even if it not clearly stated in the mining legislation), although the Myanmar Mines Amendment opens the door for future tenders. The right to the production permit is guaranteed in the event of discovery of a deposit by the holder of prospection permit.

A document published by the Ministry of Mines in July 2012⁸³ outlines procedures for foreign investors interested in conducting mineral prospection, exploration or feasibility study activities, including:

Stages ⁸⁴	Procedure
Field visit	Meeting with the Ministry of Mines, accessing geological data supplied by DGSE, assessing historical records of previous activities in the area, studying mineral maps and gathering local knowledge by the investor.
Proposal	<p>Submit a proposal or letter of intent to the Ministry of Mines copied to DGSE. The proposal should clearly mention the area of interest and include coordinates, types of minerals, proposed activities (prospecting, exploration and feasibility study), amount of capital investment, technical capacity, methods that apply for the specific mining operation, duration and general terms preferred by the company.</p> <p>The following documents are required with the proposal:</p> <ul style="list-style-type: none"> - Company Registration - Company Profile and other relevant information about the company - Recommendation and endorsement of the respective Embassy in Myanmar - Evidence of financial capacity - Evidence of technical competency - List of the Board of Directors - Details of any mineral permits held within the preceding four years in Myanmar - Initial work programme - Map of the proposed area with coordinates - Financial estimates for exploration extracting or processing operations - Measures for mitigating negative environmental, health and social effects (Environmental Impact Assessment (EIA) or initial environmental examination (IEE) based on the mineral /size of the project.
Evaluation	Assessment by the Ministry of Mines and approval of the proposal
Draft agreement	Preparation of a draft agreement (either the technical terms and conditions of an exploration permit or a PSC) including all relevant information about financial requirements (Signature Bonus, Dead Rent, Performance Bank Guarantee and minimum expenditure)
Approval	<p>Submit the draft Agreement to MONREC's "Scrutinising Committee" for assessment. Upon approval by the Scrutinising Committee, submit the application to the Ministry for approval.</p> <p>Submit the application approved by MONREC to the Attorney General's Office and the Office of the Auditor General for legal endorsement.</p> <p>Multiple external approvals are required throughout the licensing process: Applicants must generally seek the endorsement of the relevant state or regional government, township administrative department, township forestry department and township land record department. Other entities such as the Ministry of Agriculture and Irrigation or the Ministry of Finance may also be required to sign off on the project.⁸⁵</p>

⁸³ Myanmar Ministry of Mines, "Facts of JV Procedures," July 2012.

⁸⁴ Facts of Joint Venture Procedures, Mom, July 2012

⁸⁵ Ministry of Mines, "Facts of JV Procedures," July 2012 and stakeholder interviews conducted in January

Stages ⁸⁴	Procedure
	<p>The 1996 Mining Rules stipulate that additional approval for mining projects should be obtained from the Ministry of Environmental Conservation and Forestry (MOECAF). Foreign companies entering into a joint venture with the state or a state-owned enterprise must obtain a special permit from the Myanmar Investment Commission (MIC) as stipulated in the Foreign Investment Law (2012). MIC has the authority to set minimum equity participation for partners in joint venture agreements (JVAs).</p> <p>In practice, the approval process may take six months or more on average to complete.</p>
Final negotiation with relevant MONREC Enterprise	<p>Negotiation with the relevant MONREC Enterprise the economic, social and other benefits to be realised by both parties.</p> <p>MONREC is flexible on negotiating the terms of each arrangement. The sharing of production costs may be fixed for the term of the agreement or on a sliding scale depending on the level of production. The government's share of production can be inclusive of royalties, valued upon a mutually agreed price, and sold back to the investor.</p>
Issue of mining permit	

It is unclear whether, or how significantly, this process has been modified since 2012. The Ministry of Mines has not published the application procedures established for other types of permits, including prospecting, exploration, and feasibility study activities with citizen investment and mineral production permits of any scale.

During the fiscal year 2014-15, there are 733 awarded mining permits covering an area of 5,691 Km². The complete list of the awarded permits as well the data required by the EITI standard may be found in Appendix 11.

Renewal and transfer of mineral licences

Renewal of permits

MONREC may renew a permit for prospecting, exploration or production. Applications for renewing a permit must be submitted to MONREC three months before the expiry of the permit.

Transfer of permits

Permits may be transferred with the consent of MONREC and the approval of the MIC. To transfer a permit, a permit holder must submit a transfer application with a copy of the draft transfer agreement. The Myanmar Gemstone Law prohibits the "sublease or in any way transfer" of gemstone permits. Due to the large number of permits and limited capacity of MONREC, we understand that mineral and gemstone licenses are often transferred unknown to MONREC's knowledge.

A licence is not considered a capital asset and is thus not subject to capital gains tax in Myanmar. However, the sale of a permit could be considered as an 'other source of income' and under Union Tax Law (2017), the net profit realised would be taxed at 25 per cent.

Licences application' approval and review process

The Myanmar Mining Rules (1996) stipulate that subsistence production permit applications should be submitted to the relevant state-owned mining enterprise or to "the person empowered by the Ministry." However, it is unclear based on available information what other entities, if any, have been engaged in subsistence mineral production licensing to date.

Under the amended Myanmar Mining Law and amended Myanmar Gemstone Law, we understand that the review of the small-scale mining permits will be devolved to the state and regions. We understand that members of the state or region scrutinising committees will be appointed by the Union Ministry of Mines or other relevant ministries. However, it remains unclear how these subnational entities will be incentivised and capacitated to carry out their duties efficiently, or how their activities will be coordinated with the Union-level ministry.

We understand that mineral and gemstone licenses are currently reviewed and approved by a leading committee from the Ministry of Mines, which includes the Minister, the Deputy Minister and General Directors from the Ministry's departments and State Owned Enterprises (SOE). We also understand that the Ministry of Mines accepts input from the Department of Mines, the Department of Geological Survey and Exploration and the relevant mining enterprise during its evaluation. However, the respective roles of Myanmar's mining departments and SOEs are not specified within the existing legal framework.

Neither the original nor the amended version of the Myanmar Mining Law specify what financial, technical or other criteria should be evaluated for the allocation of mineral permits. We understand that applications are evaluated by the above-mentioned committee which takes into account a number of factors when scrutinising mineral license applications, including:

- Exploration data;
- Minimum investment capital;
- Infrastructure plans;
- Extraction and processing methods;
- Fiscal terms;
- Bank guarantees.

However, how these data should be weighed and measured remain unclear. Moreover, from our discussion with MONREC representatives, it does not appear that criteria such as past operational experience or financial capabilities are comprehensively assessed in the review of new license applications.

Gemstone sector case

The Gemstone Law stipulates that only "a company formed as a Myanmar company under the Myanmar Companies Act or a company formed solely with Myanmar citizens under the Special Company Act, 1950" may be awarded a gemstone production permit. Furthermore, the Myanmar Companies Act (1914) stipulates that companies must be wholly owned and controlled by Myanmar citizens. Therefore, foreign investors are completely prohibited from extracting gemstones, cannot apply for a permit and cannot even enter into a joint venture partnership with a local company.

The 1995 version of the Myanmar Gemstone Law set up a single category of gemstone production permits to be awarded through competitive bidding. In practice, JV profit sharing permits were issued on a first-come first-served basis for concessions of up to 160 acres maximum until March 2016 (and since the 1990s). However, in March 2016, in line with the 2016 amendments to the Gemstone Law, it was decided that the maximum concession size under the JV partnership system would be 50 acres, but depending on the potential volume of gemstones produced.⁸⁶

The 2016 amendments to the Gemstone Law specify that large and medium scale permits would be awarded on the basis of competitive tenders⁸⁷. The Myanmar Gems Enterprise (MGE) publishes new opportunities to tender in local newspapers and allows prospective investors one month to survey the concession site.

According to the data provided by MGE, the process and criteria of granting **licences for the common benefit with the State** is as follows:

1. The Myanmar citizen company who wish to carry out the jade/gems mining in cooperation with the State for common benefit conducts field visits and checks the land plot which they would like to apply for and draws a map and shall apply to the Myanmar Gems Enterprise with the application letter with the company letter head and duly signed by the Managing Director of the Company himself;
2. In applying so, the applicant shall apply according to the rules and regulations provided and to be followed by the applicants who apply for the worksite for common benefit with the State;

⁸⁶ Source: Gemstone Sector Review – July 2016

⁸⁷ Source: Gemstone Sector Review – July 2016

3. MGE shall assign a team comprising personnel from other regional authorities such as Township General Administration Department, Forestry Department, Land Records Department, relevant regional administrator, the executive committee member from Myanmar Gems Entrepreneurs Association to pay a field visit and check whether the land plot applied to the regional mining department in the relevant gems area is meeting the (11) points provided in applying worksite or not. The license should be granted or not, and the field findings shall be reported back;
4. After receiving the field findings report, it shall be presented to the Gems Worksites Licenses Granting, Inspection and Supervision Committee headed by the Minister for the Ministry of Mining and with the participation of Director-Generals and Managing Directors. The Supervision Committee shall discuss and decide whether the license for the worksite applied for should be granted or not and it is presented to the Myanmar Gems Development Leading Committee headed by the Secretary;
5. Presentations shall be discussed and coordinated at the meeting of the Leading Committee and the worksites which are meeting the provisions are granted licenses; and
6. For the worksite for common benefit granted, Kyats (10) lakhs each for (1) acre of worksite must be deposited as worksite proposal fees. Deposit is pre-paid for the work to be carried out.

According to the data provided by MGE, the process and criteria of granting licences for Designated/Revealed Worksites and Vacant Worksites is as follows:

1. Out of the worksites in the gems area working and producing gems by obtaining licenses according to the Myanmar Gems Law by the national citizen private, company and cooperative societies, the designated worksites, revealed worksites and vacant worksites to be expired within January, February and March 2016 are to be issuing licenses through the competitive price system performed according to the Myanmar Gems Law (Section-12), (Section-13) and (Section-15);
2. The proposed company for the worksites shall apply the proposal together with the Bank Statement from the Myanmar Economic Bank (or) any Private Bank recognized by the State proved to be financially viable and validity;
3. Work registration, taking out the proposal application and submission of the proposal has to be communicated and performed with the Myanmar Gems Enterprise as follows:
 - **Work registration and taking out proposal application:** Since (14th) October 2015, according to the Myanmar Gems Law, registration fees can be paid to the Myanmar Gems Museum, Myanmar Gems Enterprise (Headquarters), Nay Pyi Taw and work registration can be made, taking out the proposal application form and seeing and studying the worksite map
 - **Submission of the proposal application:** The person who wants to submit the proposal shall fill up all necessities completely in the designated worksite proposal form (MaKaLa-2) and Attached Form (ThaMa-1) for the designated worksite, in the revealed worksite proposal form (MaKaLa-5) and Attached Form (PhaHta-1). Such proposals shall be separated into one by one and put one each inside two envelopes sealed inner and outer and submitted to the Myanmar Gems Museum, Myanmar Gems Enterprise, Nay Pyi Taw within (14th October 2015) and (13th November 2015) according to the provisions;
4. In the submission of sealed proposal with competitive price system for the gems worksites, guarantee deposit Kyats (ten lakhs only) for one proposal (for one worksite) shall be paid to the Myanmar Gems Enterprise);
5. The floor price for one worksite of gems worksites to be proposed and applied for is Kyats. 1,000,000 (Kyats ten lakhs only);
6. The persons and companies put in the black list shall never (never) be allowed to propose and apply for jade and gems worksites; and
7. As the list of gems worksite advertised and all worksite map is stick/advertised on the notice/advertising board at the Myanmar Gems Enterprise (Headquarters), Nay Pyi Taw, the list of worksite and worksite map by relevant gems area wise is stick/advertised on the

notice/ advertising boards at the gems mining departments at Mogok and Mine- Shuu town and jade mining camps at Phar-Kant, Moe-Hynin and Khann-Tee town and the persons who want to know the details can go, communicate and see the advertisement there.

According to the data provided by MGE, the process and criteria of granting **licences for Expired Worksites and Designated Worksites** is as follows:

1. The expired worksites and designated worksites (new) in various gems areas are called by advertising in the daily newspapers. If the entrepreneurs wish to apply for the worksites called by advertising, they shall propose and apply for within the prescribed period with the sealed tender system. The list of expired worksites is stick at the notice/advertising boards at the office of MGE, Nay Pyi Taw and respective department offices of the Mining Department;
2. Proposal application must only be submitted for the worksites advertised. The worksites not included in the advertisement must not be proposed and applied;
3. The renewal application for the expired worksite must be one proposal each for one worksite. For purchasing proposal application form, the following evident documents must be presented:
 - Company Registration Certificate (Original/Copy);
 - Form 6/ 26 (Original/ Copy);
 - Membership Certificate of Gems Entrepreneurs Association (Original/ Copy);
 - The Citizenship Scrutiny Card of the entrepreneur who wish to apply (Copy);
 - Letter of the Representative if it is represented;
 - The Citizen Scrutiny Card of the Representative (Copy); and
 - Bank Statement.
4. If the company is not included in the black list and the company is live company (not expired) the company by showing above-mentioned evident documents and pay Kyats. 1000 for registration fees and must purchase the total number of application forms, one proposal application form each for one worksite and pay Kyats 300 per application form, based on the total required worksites to be applied for.
5. After purchasing the proposal application forms, guarantee deposit Kyats (1,000,000) (Kyats Ten Lakhs only) for each proposed worksite wish to be applied for must be paid to the Myanmar Economic Bank by obtaining Deposit Chalan;
6. After depositing the guarantee deposit, the deposit chalan must be exchanged with the voucher;
7. After filling up the points contained in the application correctly and completely, the applicant shall put application form attached with the bank statement into an envelope and addressed to the Chairman, Myanmar Gems Worksite License Granting, Inspection and Supervision Committee and write the name of the company applied on the envelope and sealed it and shall present to the Proposal Acceptance Team;
8. The Proposal Acceptance Team shall write the guarantee deposit voucher No. and registration No. on these sealed envelopes and enter it into the register;
9. The envelopes entered into the register shall be checked by the officer-in-charge and relevant entrepreneurs shall be assigned to put into the tender boxes differentiated according to the region/worksite/ jade mine;
10. The proposal boxes have had two covers and each cover has been locked with two keys each and inner cover is locked with two keys and sealed these locks and the keys are given to the Director. The outer cover's keys are handled by the Proposal Acceptance Team and the boxes are open when the proposals are put into the boxes;
11. The period for proposal submission is fixed a total of (30) days;

12. The tender boxes in which the applications for the worksites proposed are put shall be open and checked at the meeting of Myanmar Gems Development Leading Committee and presented according to the similarity of worksite and in order of money from less to more;
13. The Myanmar Gems Development Leading Committee grants the license according to the Law, Rules and prescribed procedures
14. The original entrepreneur is given priority to be granted by paying proposed money as the highest price proposed. If the original entrepreneur cannot pay the money, the competitive entrepreneur (who pays the highest price) is granted the license;
15. The licenses for the worksite granted against with the list of the names of entrepreneur who got the license is stick at the advertising/notice board. Besides, the entrepreneurs are acknowledged for the deposit of proposal money for the worksites to be granted and for getting license card; and
16. The guarantee deposits paid for the worksites not granted for licenses are refunded.

During the fiscal year 2014-15, there are 223 awarded gemstone permits covering an area of 223 hectares. The complete list of the awarded permits as well the data required by the EITI standard may be found in Appendix 11. According to MGE these permits were awarded following the above procedures and criteria. [As mentioned in Appendix 11, the list of applicants for the permits awarded on the basis of competitive tenders is not available.](#)

Efficiency and effectiveness of these systems

The decision on whether to allow natural resource extraction requires the consideration of a range of factors including among others the technical and financial capacity of the licence holder, the revenues and other benefits that the project will bring and the potential social and environmental risks associated with the mining project.

[Currently, information such as the assessment criteria for the award, renewal and transfer of mining permits is not disclosed.](#) How the applied criteria are weighed and measured and the evaluation process are unclear. This situation may lead favouritism or corruption.

MONREC receives numerous applications for mining permits/licenses which need to be processed within the required timeline including those applications that are still under appeal. However, due to the limited manpower resources available, the processing of these requests could be delayed, which may result in a backlog of pending applications from various stakeholders.

It is important for Myanmar to carry out an assessment of the current legal and regulatory framework in order to ensure that best international practices on responsibility and transparency are taken into account. We also recommend to improve the evaluation and the award process and make information on award criteria public and accessible. The role of Government Agencies including SOEs should be also clarified and included in the legislation governing the mining sector.

3.3.15 Local contents and social payments

We understand that currently, there is no specific law relating to CSR for the mining companies in Myanmar. Some extractive companies are engaged in quite substantive CSR initiatives on a voluntary basis. In the absence of any kind of legal requirement or framework for community development, such as a Community Development Agreement (CDA); an Impacts and Benefits Agreement (IBA); or a Social and Labour Plan (SLP), companies are only required to mitigate negative impacts around the extractive industries (as per the Environmental Conservation Law, 2012), not to contribute to development. [However, there is little availability of data on voluntary social payments, still less public domain budgets or audited reports.](#)

3.3.16 Reforms in mining sector

Myanmar Mining Law

Recent amendments to the Myanmar Mining Law of 1994 through the enactment of Law N°. 72/2015 on 24 December 2015 (the "Mining Law Amendments") constitute some progress towards addressing areas of concern to potential investors.

The changes brought by the Mining Law Amendments include:

- increasing the maximum production permit period to 50 years for large scale production projects only;
- giving exploration permit holders a clear right to production permits;
- allowing joint ventures, between foreign investors and local investors, in the case of small and medium scale production projects upgraded to become large scale production projects;
- specifying the criteria for determining the size of individual production permit areas; and
- providing a guaranteed right to extraction/production permit for those who have successfully carried out prospecting and exploration and completed a feasibility study.

A summary of the other major amendments under the Mines Law Amendments is provided in the table below:

N°	Topic	Amendment
1	Large Scale Extraction/Production (Section 2(k))	Permit term is now 15 to a maximum of 50 years
2	Foreign Investment (Section 4(a))	Specifically allowed for any of: (a) prospecting (b) exploration & testing (c) feasibility study (d) Large Scale Extraction/Production only (e) processing (f) trading and selling
3	Joint Ventures (Section 4(f))	Joint ventures with foreign investment are allowed for large scale extraction/production by way of conversion or upgrading of existing locally owned small or medium sized projects depending upon: (a) survey reports (b) quality and volume of deposits
4	Permits (Section 7(a) & (c))	Ministry of Mines with consent of Union Government authorised to grant permits for: (a) all permitted mining projects with foreign investment (b) conversion/upgrade of locally owned small/medium scale projects to large scale extraction/production projects operated as joint ventures with foreign investment
5	Classification of Production (Section 11)	(Section 11(a)) - All permits for other non-foreign investment projects to be granted by newly formed Regional or State Permitting Boards. Classification of production scale will be made taking into account: (a) operating conditions/area (b) distances (c) amount of investment required (d) equipment and machinery usage
6	Right to Extraction/Production Permit (Section 11(a))	A guaranteed right to extraction/production permit for those who have successfully carried out prospecting and exploration and completed a feasibility study
7	Availability of Buying/Selling Permits (Section 11(b))	Non-producers wanting to carry out purchasing and processing of minerals may obtain buying/selling permits
8	Royalty Payment Currency (Section 12(g))	Foreign investors must pay royalties: (a) in Myanmar currency (b) calculated using exchange rate published by central bank
9	Royalty Rates (Section 18)	Applicable rates change as follows: (a) gold, platinum, uranium etc. - now 5%, previously 4% to 5%

N°	Topic	Amendment
		(b) silver, copper, tungsten etc. - now 4%, previously 3% to 4%
		(c) iron ore, zinc, lead, aluminum, manganese etc. - now 3%, previously 3% to 4%
		(d) industrial minerals and stone - now 2%, previously 1% to 3%
10	Calculation of Royalty Amount (Section 19)	Royalty amount to be calculated based on: (a) percentage of pure metallic mineral content (b) using prevailing international prices
11	Environmental Obligations (Section 13(e)(1))	Obligation to set up a reserve fund for environmental conservation
12	Reclamation Obligations (Section 13(e)(2))	Obligation to prepare and carry out mine exit/reclamation plan re post mining period
13	Exclusion of Gemstones (Sections 2(b), 19 and 21)	Gemstones and gemstone mining are no longer part of Mines Law and will, presumably, be separately regulated
14	Offences and Penalties (Sections 30(a) and 32-A)	Large increases in prison terms and fines for Mines Law offences
15	State Participation (Section 35(A))	Ministry of Mines may carry out mineral extraction/production with permit holders jointly/in joint venture Ministry production joint ventures shall be in the form of: (a) production sharing with allowance for certain expenses (b) equity sharing (c) profit sharing based on parties' respective contributions

Myanmar Gemstone Law

The second amendments to the Myanmar Gemstone Law (23/2016) were passed by the Pyidaungsu Hluttaw on 29 January 2016. The first amendments were made in 2003 and were minimal. The second amendments (2016) update approximately 75% of the 1995 Law. 17. Notable changes include:

1. Clearer categorisation of gemstone products (previously not clarified):
 - a. rough gemstones;
 - b. finished - cut, polished, refurbished, shaped and sculpted out of rough gemstones and gemstones that have not been turned into jewellery yet;
 - c. jewellery; and
 - d. items made of gemstones.
2. Gemstone Production Permits (previously just one permit type – 'gemstone production permit' - now categorized as follows):
 - a. large-scale exploration and production – commercial scale, technology and machinery to be used as designated by MONREC, tenure = 10 years, awarded via competitive bidding;
 - b. medium-scale exploration and production – commercial scale, technology and machinery to be used as designated by MONREC, tenure = 5 years, awarded via competitive bidding;
 - c. small-scale exploration and production – 'a business without needing much capital', technology and machinery to be used as designated by MONREC, tenure = 3 years, awarded via application; and

- d. very small-scale exploration and production - using manual operation equipment or a machine with very low horsepower, as designated by MONREC after discussing with the State or Division Government, tenure = 1 year, awarded via application.

The amended law does not provide any further clarity or definition for these categories.

3. A new 'Permit to Use Land' will be awarded for the building of temporary structures, warehouses and accommodation relevant to gemstone extraction and production, for keeping vehicles, machinery, for sorting, producing and cutting rough gemstones, for washing waste material, and for dumping waste material.
4. Strengthened requirements regarding how a gemstone tract and block is identified and designated (Chapters 3 and 4), including:
 - a. large scale and medium scale - MONREC retains control, determines floor price, invites competitive bids, issues permit to company with the highest bid, shares profit with permit holder; and
 - b. setting up of State or Division 'Scrutinising or Permitting Bodies' – with power to evaluate applications, issue Small Scale or very Small-Scale permits, and to determine their floor price and tenure
5. New Royalty /Service Charge (Replaces 10% Foreign Currency Sales Royalty, of which 3% is retained by MGE and 7% goes to IRD):
 - a. 3% service charge on sale value of rough gemstones (after the stone has been registered and production royalty paid); and
 - b. 1% service charge on sale value of finished gemstones, jewellery or any items made of gemstones.
6. Strengthened responsibility for MGJEA (Central Supervisory Committee and Gems Emporium)
7. Inspection – role of Chief Inspector as DG of Ministry of Mines remains the same, however with clarified responsibility for MGE officers to be designated inspectors as well as officers from the Department of Mines.
8. Penalties and Offences – reduction of some terms e.g. number of years of imprisonment
9. Slightly strengthened environmental and social considerations
10. 2% of permit-holder profits to 'go toward a fund for the development of health, education, transportation and other items where necessary for the operation region'. No further elaboration on this is provided.

Myanmar Mineral and Gemstone Cadaster

A project for the development of a unified Mineral Cadaster System has been initiated in 2017. The objectives of this project are to:

- provide a robust and transparent system for the management of mineral and gemstones licenses consistent with the Minerals and Gemstone Laws;
- provide guidelines for appropriately formatted data, maps and reports for internal and external clients. This includes national natural resource and land management;
- provide various levels of security and access to the information, reflecting the various functional roles in license administration;
- provide reports and statistics for internal use and external dissemination;
- provide systems for dealing with issues of non-compliance and notices to companies for minor breaches; and
- provide a client-focused and user-friendly interface with the investing community.

The phase 1 of this project consists on initial diagnostics and data gathering and the development of a conceptual design of the proposed Mineral Cadaster System (including resource estimates: financing, timing, staffing, etc.). The preliminary diagnostic report with regards to the phase 1 has been issued in November 2017.

Following ministerial approval of Phase 1, a consulting firm will be recruited by MONREC for a period of approximately 24 months to compile data, design, install and train local staff in the management of the Mineral Cadaster System. This will constitute the phase 2 of the project.

3.4. Budget process and public finance and revenues management reforms

3.4.1 Budget process

In Myanmar, the fiscal year is from 1st April to 31st March. The Ministry of Finance issues the Budget Calendar to the Government agencies. The Union Level Organizations (including SEEs) submit their budget proposal to the Budget Department (Head Office). Budget Department is responsible for current expenditure, Planning Department is responsible for capital expenditure and Treasury Department is responsible for financial expenditure. After that Budget Department compiles the current, capital and financial expenditures and submits to Deputy Minister of Finance. The Deputy Minister scrutinizes the budget for each department after preliminary scrutinizing. Then, Minister of Finance scrutinizes and submits to Vice Presidents for scrutinizing. After scrutinizing by Vice Presidents, the proposed budget is submitted to the Financial Commission for further scrutinizing and discussion. The Ministry of Finance on behalf of the Union Government submits the Union Budget Bill and Budget Proposal to Pyidaungsu Hluttaw with the recommendation of Financial Commission. After discussing and approving by the Pyidaungsu Hluttaw, the President signs the Union Budget Law and it is enacted. It is published in newspapers and www.mof.gov.mm MoF Website. The Budget Department issues the Budget Sanction to the government agencies according to Union Budget Law. The Union Budget Law includes the funds transfer from Union to States/Regions. Parliamentary discussions on Budget Sanction can be found on TV Channels and local newspapers.

The budget preparation process can be presented as follows:

Budget Preparing Process

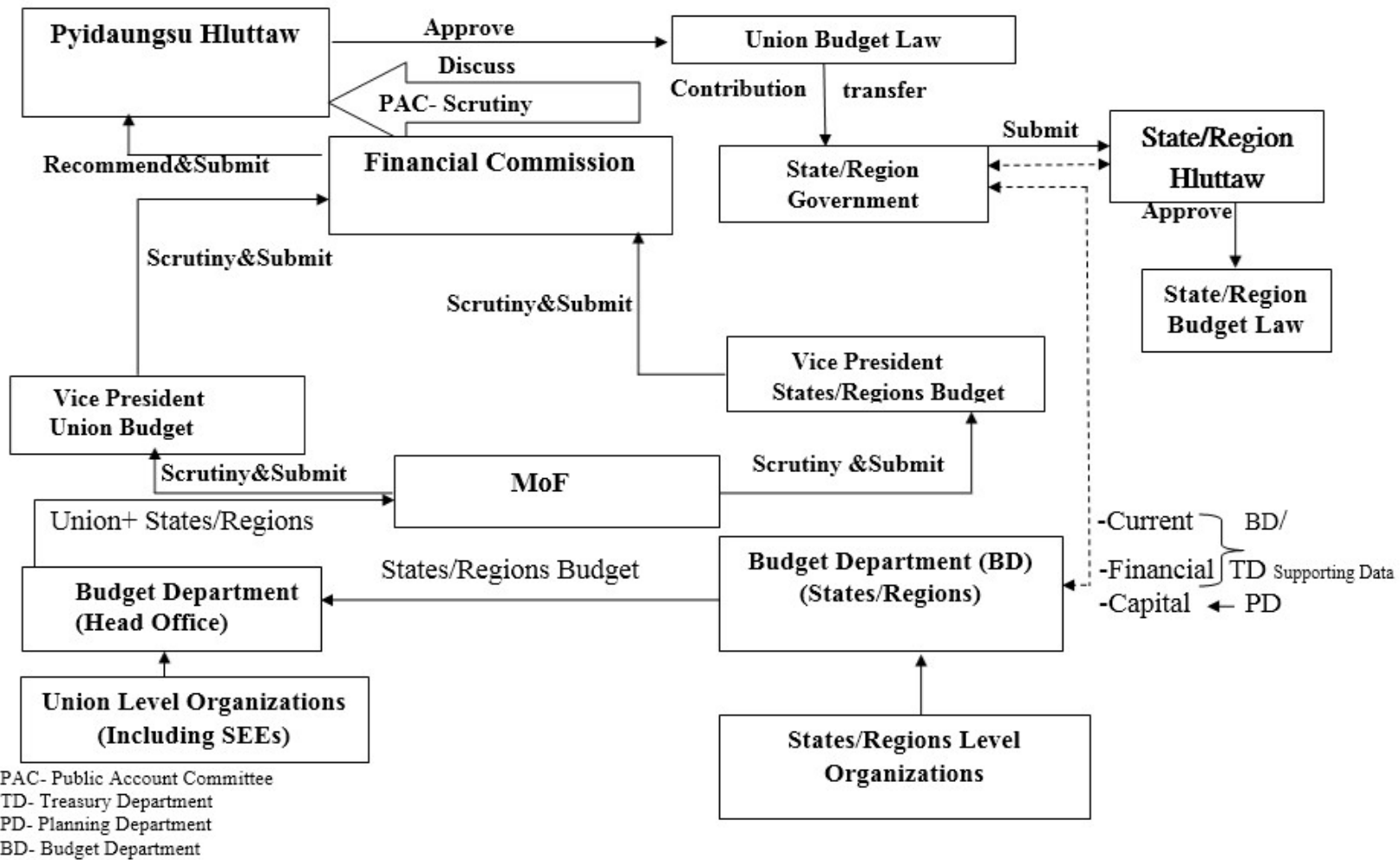

In Myanmar, Government accounting is on a cash basis, following the single entry system. The budget of Myanmar is financed by funds from four primary sources: tax revenues; revenues from natural resources; income from State Economic Enterprises (SEEs); and other non tax revenues (various government fees and charges).

Starting from 2012-2013 Fiscal Year, there have been significant budgetary developments in Myanmar which include changes in the way in which State Economic Enterprises (SEEs) are financed and how they contribute to the budget. Fiscal decentralization has also begun albeit on a limited basis. SEEs are required to find their own funding to finance raw materials, fuel and other direct costs of production, and they can borrow the money with 4 percent interest rate from Myanmar Economic Bank when they needed. This is expected to increase overall fiscal space, as well as fiscal space of the social sector.

Although State Economic Enterprises (SEEs) budget is included in State Budget, some portions of their budgets run with their own funds. Financing of the budget deficit of SEEs will be provided or loaned from Union Fund which approved by cabinet of Union Government. According to our interview with MoF representatives, the structure of the Union Fund for 2012-2013 Fiscal Year can be presented as follows:

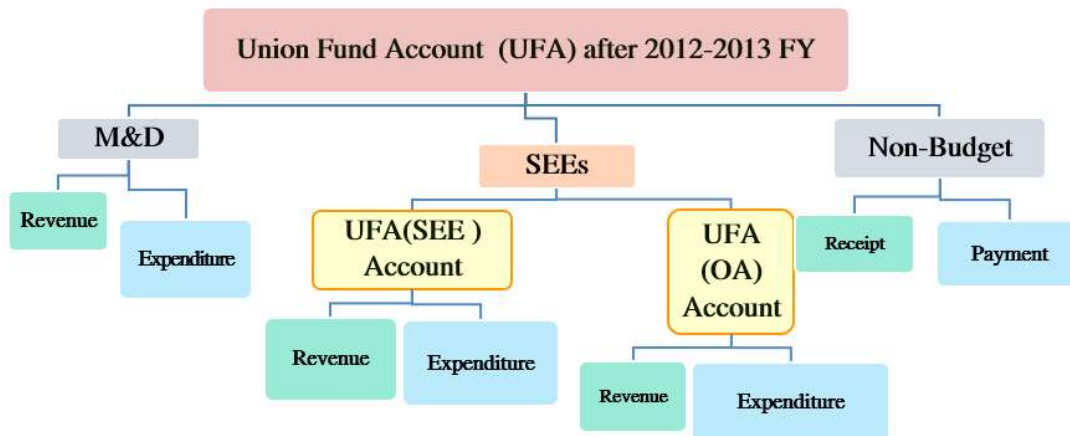

In 2014-2015, if SEEs get profit, 100% of the purchase of raw materials, Income Tax and State Contribution under the current expenditure shall be carried out their own fund and the rest of current expenditure, capital expenditure and financial expenditure shall be carried out the Union Fund. If SEEs get loss, 80% of the purchase of raw materials under the current expenditure shall be carried out their own fund and the rest of current expenditure, capital expenditure and financial expenditure shall be carried out the Union Fund.

According to the Section 15 (a), (b) and Section 16 of Union Budget Law 2014 and our interviews with representatives from MoF, we understand that all the receipts and expenditures of the SEEs, including those carried from their Other Accounts are consolidated under the Union Budget.

Since 2011, the Parliament has set up two specialised committees for the purpose of providing oversight of the Government's public finances. The Public Accounts Committee (PAC) has a bipartisan membership and vets the budget bill and the audit report. The Planning and Finance Development Committee is responsible for reviewing the national development plan and legislative matters relating to the financial sector. Since 2012-2013 these committees have reviewed and rationalized the executive budget proposal significantly and have been instrumental in having the approved Budget Law published in the local press.

In order to coordinate and integrate state and regional budgets with the Union budget, the government has also set up the Financial Commission and the National Planning Commission. Since 2011, the new planning and budgeting practices has resulted in a decentralization of Public

Financial Management (PFM) policy functions from the President’s Office to the Ministry of Finance and the Ministry of National Planning and Economic Development (MNPED) respectively.

When it comes to the account of the Union Government, Union Fund Account or UFA is opened and kept at Myanmar Economic Bank and Union Government Deposit Account or UGDA is opened and maintained at Central Bank of Myanmar.

All the branch offices of Myanmar Economic Bank have to consolidate the balance of the accounts of the Government. Thus, the Head office of Myanmar Economic Bank has to consolidate the UFA surplus or deficit balances, prepare a total consolidated balance of UFA surplus and deficits and go through the accounts with Central Bank of Myanmar weekly and monthly.

The funds that are deposited or drawn from Union Government Deposit Accounts at Central Bank of Myanmar are:

- Net surplus or deficit of Union Fund Accounts;
- State Contributions or refunds of State owned Economic Enterprises;
- Sales and redeemable of Treasury Bills;
- Sales and redeemable of Treasury Bonds;
- Financing the budget deficits of Regions and States; and
- Accounts opened at Central Bank of Myanmar to process the net surplus and deficits of the sub-national vaults.

Diagram of the operation of Union Fund Accounts

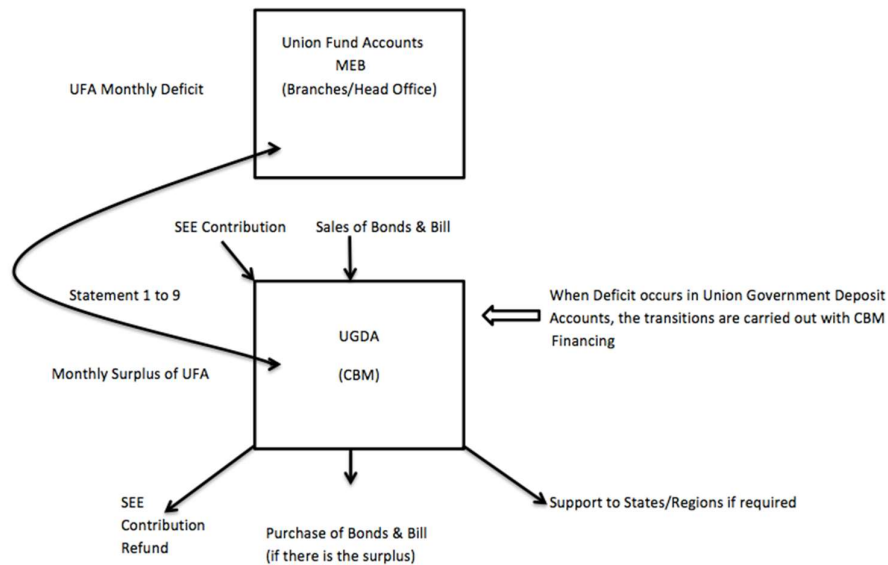
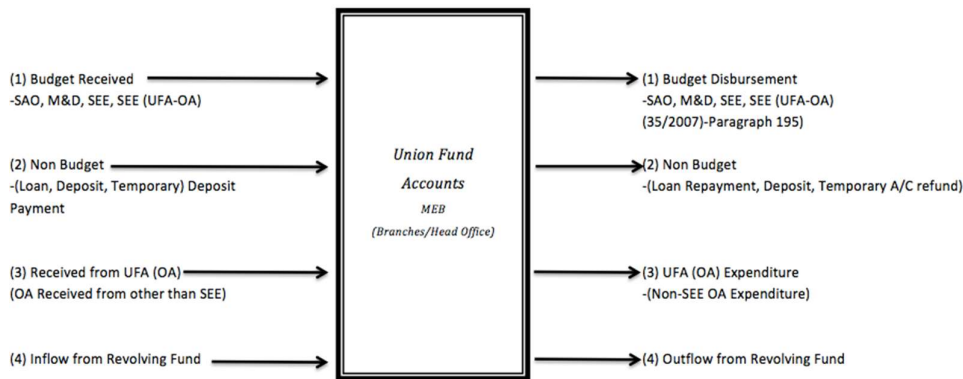

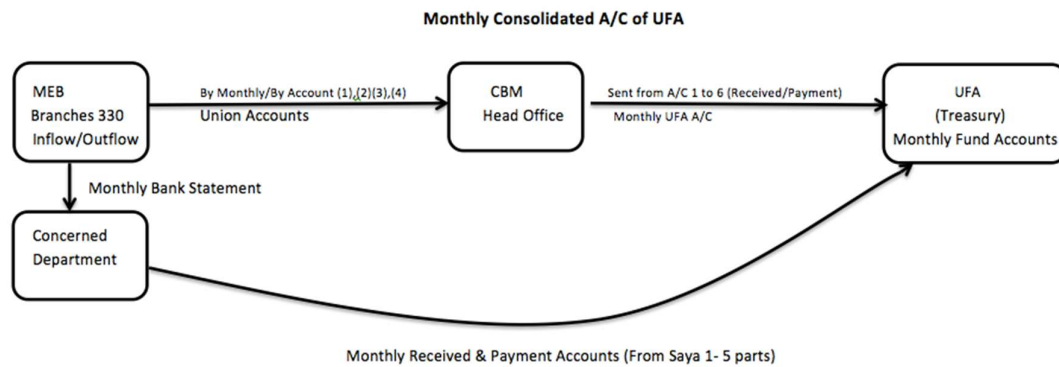

3.4.2 Public finance and revenues management reforms

Public Finance Management (PFM) reform in Myanmar

The objective of PFM is to support efficient, accountable and responsive delivery of public services through the modernization of Myanmar's PFM system and strengthening institutional capacity.

- Implemented PFM reform process in accord with the Framework of Economic and Social Reform (FESR) since 2011
- Conducted an assessment on Public Expenditure and Financial Accountability in Myanmar and successfully published Public Financial Management Performance Report at 2013 collaborating with World Bank
- Established PFM Strategy (2013) for PFM reform
- Conducted Public Expenditure Review (PER) in order to analyze the resulting expenditure patterns and related sector outcomes from PFM System with the aim of assessing public resources achieving the desired development objective. There are six areas in PER's first phase: Macro Fiscal Context, Broad Revenue and Expenditure, Intergovernmental Fiscal Relation, Electric Power and Energy, Health and Education
- Cooperated with IMF for strengthening PFM system, Treasury Function and for analyzing budget formulation
- Organized PFM Sub-Sector Working Group (SWG) under Public Administration Working Group among 17 SWGs (Nay Pyi Taw Accord)
- Myanmar Modernization of Public Finance Management Project (MMPFMp) is 5 years project from 2014 to 2019

The implementation of PFM project will be done through the following five areas:

- Revenue Mobilization
- Budget preparation and planning
- Budget Execution
- External Oversight
- Capacity Building

Revenue Mobilization

The following reforms are in progress:

- Conducted Tax Policy and Tax Administration Reform;
- Established Large Taxpayer Office (LTO) and Medium Taxpayer Office (MTO 1, 2 and 3)
- Transformed Office Assessment System (OAS) into Self-Assessment System (SAS) and started to practice at LTO and MTO;
- Identified Specific Goods Tax and Enacted Specific Goods Tax Law in 2015;
- Changed Commercial Tax to Value added tax and special commercial tax;
- Updated information technology system;
- Installed IT equipment and
- Increased Tax to GDP ratio year by year

Budget Preparation and Planning

The following reforms are being implemented in the budget preparation and planning:

- Separated the Consolidate State Fund into the Union Fund and States/ Regions Fund since 2011
- Practiced Medium-Term Fiscal Framework (MTFF) since 2015-2016 FY in order to improve the budget formulation process year by year and to support macroeconomic stability and development.
- Developed a system of top-down budgeting and bottom-up planning
- The Budget Department is the implementer of MTFF process.
- Allocated more expenditure to Social Sector such as Education and Health by setting up the top point in Expenditure policies with respect to prioritized areas of the country.
- Provided subsidies and fiscal transfers to States/Regions by practicing MTFF (six indicators: total population, poverty index, area, per capita GDP, urban population as percent of total population and per capita tax collection);
- Improved fiscal decentralization
- Improved fiscal transparency (Enacted Budget Law has been publishing in newspapers and MOF's website, Citizen's Budget has been publishing starting from 2015-2016 FY)
- Updated Financial Rules and Regulations

IRD Strategic plan 2014-2020

The following objectives were set up in IRD strategic plan 2014-2020:

Objectives	Description
Develop a robust legal Framework within which the IRD can operate effectively	Legislation will be reviewed and updated to support the new administrative approaches such as self-assessment. A tax administrations procedures code will be developed and the revenue acts will be re-written. VAT legislation system will be introduced.
Re-organize IRD to fit with the new administrative approaches	The organization will be restructured based on functions (taxpayer service, return and payment processing, return filing compliance and arrears, Audit, Disputes resolution, Legal and tax rulings) with a strong taxpayer segment (LTO, MTO and STO) orientation. Headquarters will be reorganized to better guide and direct the organization.
Modernize the process for assessing taxation	Move from an official assessment system (OAS) where the IRD calculates the tax to a self-assessment system (SAS) where the taxpayer calculates the tax payable within strict guidelines. introduce a VAT system of indirect taxation.
Streamline and simplify all business process and procedures and make full use of technology	All business processes will be reviewed and technology will be utilized throughout the tax administration functions.
Balance services and enforcement approaches to address revenue risk	Develop capacity to focus on the management of systemic and segment-related risks. A range of taxpayer services will be developed based on the needs of taxpayers and the revenue. Enhance enforcement activity to ensure those who do not comply will be identified and dealt with.
Develop our people and maximize their potential	All human resource systems, processes and procedures will be reviewed and modified to support the new administrative approaches. Development programs will be established for segments, functions and individuals to bring skill levels in line with the changes.
Develop and implement leadership and governance arrangements to manage the changes	Capacity will be developed and put procedures in place to manage these significant changes as they impact on our systems, our people and stakeholders. Processes will be put in place to ensure engagement occurs with our people and key stakeholders in particular.

Objectives	Description
Build transparency and accountability into all aspects of the administration	External and internal transparency and accountability structures will be built. These structures will help create an environment of public trust in the integrity of the tax system.

IRD use the use the following approaches to manage the reforms:

- Reforms will be managed and led by the Republic of the Union of Myanmar Revenue Department;
- New approaches will be implemented progressively;
- All reforms will be implemented in LTO initially before being applied to the rest of IRD;
- Headquarters will be re-organized to better support the new approaches, and guide and direct the organization;
- International best practices adjusted for Myanmar environment will be applied to the reforms;
- All projects and activities will be planned;
- Project management disciplines will be applied to all activities; and
- All projects when completed will have a post implementation review undertaken so lessons can be learned.

IRD reform journey – a plan to mobilize domestic revenues 2017-18 to 2021-22

IRD commenced the process of transforming to a modern tax administration in 2012. The main changes are as follows:

- the national headquarters have been restructured along functional lines;
- a reform program governance mechanism has been introduced;
- the Large Taxpayer Office has been established to manage high value taxpayers under a system of self-assessment;
- preparations have commenced for the first of our Medium Taxpayer Offices to expand the self-assessment system to more taxpayers
- changes have been made to the tax policy and legislation framework with: an excise tax (known as specific goods tax (SGT)); a unified Tax Administration and Procedures Law (TAPL) has been drafted; and proposals are underway to modernize the Income Tax law;
- an interim IT system has been developed (Tax Revenue Management System) to support the Large Taxpayer Office;
- implementation of a data center to network key IRD offices and provide email, desktop applications and document sharing is nearing completion;
- Improvements in service to taxpayers;
- Improvements in enforcement activity; and
- Steps taken to combat corruption.

The IRD reform journey sets out the IRD Strategic Outcomes as follows:

Outcomes	Description
Maximize revenue	Maximize revenue collection over time and within the law
Broaden the tax base	All those who should be in the system, are in the system. Indirect taxes in the form of VAT will be a feature of the tax system
Maintain and improve compliance	Taxpayers will understand their obligations and comply voluntarily. Enforcement activity is targeted at those who choose not to comply. Systems and processes are aligned to ensure all taxpayers are treated equally and information is available.
Modernize Tax administration	Tax administration IS modernized and based on international best practice tailored for the needs of Myanmar

Integrity, transparency and accountability

Integrity, transparency and accountability will be achieved through a number of programs such as modern tax laws, human resource management, technology and streamlined processes and procedures. The work outlined will build on the work done to date within IRD to address integrity issues. However, expanding the focus of Internal Audit and establishing the Internal Affairs Unit are tangible steps IRD will take to ensure the integrity of its operations.

The outcomes expected by 2022 are as follows:

- Internal Audit Directorate established and focused on ensuring integrity of accounting and operational procedures and manage enterprise risks;
- Internal Affairs unit established to identify and take action against conapt behavior;
- Separation of duties to minimize opportunities for conapt behavior;
- Public perceptions of integrity have improved;
- the operational activities are monitored against an agreed set key performance indicator;
- Extensive use of data to monitor IRD' s core tax functions; and
- A taxpayer charter and staff code of conduct in place

Modern Tax Laws

The tax laws need to be updated to meet good practice in tax administration and to support a system of self-assessment. The laws need to help taxpayers understand their obligations and compliance responsibilities. They must also ensure that we have the authority to collect taxes due under the law. Enacting a uniform tax procedure law, an updated income tax law and in time a new value added tax law will position Myanmar as a truly modern tax regime.

The outcomes expected by 2022 are as follows:

- Tax Administration and Procedures Law enacted
- Income Tax Law rewritten
- VAT policy developed

Functional based organization with segmentation

Modern tax administrations have strong direction and management from the central headquarter group. IRD has made some important changes to organize our headquarters along functional lines. New directorates are building their capacity and capability. Further units/directorates will be added to our headquarters and we will enhance our management of both the delivery of our current operations, but also delivery of the changes detailed in this plan.

The outcomes expected by 2022 are as follows:

- Headquarters structure and governance mechanisms strengthened;
- New headquarters units will be established: DDG Reform, Internal Affairs, Communications, Office of the Director General, Risk and Intelligence Unit;
- Taxpayer segments accurately identified; and
- Proposal for expansion of self-assessment to small and micro taxpayers developed.

Large Taxpayer Office

IRD established a Large Taxpayer Office based in Yangon. This group has paved the way for implementing a system of self-assessment for a selected group of large companies. They have also developed new processes and procedures for administering the tax laws. These processes and procedures will form the basis for the Medium Taxpayer Offices. However, over time the Large Taxpayer Office needs to evolve to be the group responsible for all aspects of tax liabilities for the highest value taxpayers in Myanmar.

The outcomes expected by 2022 are as follows:

- Large Taxpayer Office (LTO) strengthened to manage all large taxpayers for all key tax types.

Medium Taxpayer Office

Building on the success of the Large Taxpayer operations IRD is establishing the Medium Taxpayer Offices. The first of the Medium Taxpayer Offices will start assessing returns based on the same approach as the LTO for the 2017/18 processing year (2016/17 income year).

The outcomes expected by 2022 are as follows:

- Medium Taxpayer Office's operating on functional basis in Yangon, Mandalay and other key sites.

Effective change management

Delivering the changes set out in a systematic and timely manner is crucial for the integrity of IRD going forward.

The outcomes expected by 2022 are as follows:

- Reform strategy, operational plans and key performance indicators reflect changes needed;
- Progress is monitored and used to help decision making; and
- Staff and key stakeholders (members of parliament, tax agents and taxpayers).

People and Human Resources

A key focus is the development of human resources. As IRD become a more modern tax administration so too does the needs and capabilities of staff change. Recruiting new staff, developing existing staff and providing clear statements of our expectations of the roles and responsibilities of the staff of IRD are critical aspects for our next phase of reform.

The outcomes expected by 2022 are as follows:

- HR strategy for recruitment and retention of skilled staff, appropriate remuneration policies and practices to reduce corrupt behavior will be developed and implemented; and
- Workforce planning and training programs will be in place.

Streamlined processes and procedures

IRD need to move away from paper-based processes and leverage the opportunities that technology provides for the IRD. Streamlining processes will allow IRD to work in more rewarding jobs and ensure that its services and operations are effective and efficient.

The outcomes expected by 2022 are as follows:

- Efficiencies in key areas -taxpayer services unit established, centralized data capture team, and telephone services especially for Large Taxpayer Office and Medium Taxpayer Office taxpayers;
- Processes and procedures reflect good international practice and leverage technology; and
- Headquarters monitoring compliance across IRD with mandated processes.

Risk based service and enforcement

A self-assessment tax regime is supported by education of taxpayers who want to do the right thing and strict enforcement of the law where taxpayers do not comply with their legal obligations. To encourage compliance, IRD need to have a balance between service and enforcement, a key characteristic of self-assessment systems. A Compliance Improvement Strategy, based on analysis of data received directly by the IRD and sourced from third parties will guide our service and enforcement strategies.

The outcomes expected by 2022 are as follows:

- Risk based compliance improvement strategies (based on accurate data) are used to improve on-time filing, on-time payment and accurate reporting of tax liabilities for self-assessed taxpayers.

Technology

Technology improvements will be a key feature of this phase of the reform journey. Implementation of a data centre and networking the computers will enable staff to utilize an internal email domain(name@ird.gov.mm). share documents and communicate electronically. The implementation of the new core IT system (ITAS) will provide the platform for registration, processing, accounting, and case work.

The outcomes expected by 2022 are as follows:

- Integrated tax administration system operating in key sites headquarters, Yangon, and Mandalay; and
- New and updated e-services: IRD intranet and email domain, website, telephone services, e-file and e-pay mandated for large and medium taxpayers.

System of Self-Assessment

A key feature of modern tax administrations is the shift to self-assessment. We commenced this with our Large Taxpayer Office and are in the process of expanding this to the first of our Medium Taxpayer Offices. A future Value Added Tax will depend on our ability to manage a system of self-assessment couple with a good information technology system.

The outcomes expected by 2022 are as follows:

- Self-assessment taxpayers account for 80-90 percent of revenue collection; and
- more public information material is available in a variety of media (brochures and website).

Custom Reform and Modernisation Strategy 2017- 2021

This reform and modernisation strategy is intended to guide the Myanmar Customs Department towards fulfilling its vision and mission, and thus to contribute to Government outcomes. The strategy promotes the progressive development of organisational capability in all of the functions for which the Department is responsible, supported by the modernisation of systems, resources, and working practices. This will be achieved through a well-trained, flexible workforce that meets the highest standards of integrity and public service. The strategy reflects the reform objectives of the Government of the Republic of the Union of Myanmar and is aligned with all relevant legislative frameworks.

The strategy, and the strategic action plan, will together enable the Myanmar Customs Department:

- To enhance revenue collection, and prevent evasion and loss of revenue, by implementing effective fiscal control measures on the one hand, whilst introducing a range of measures to facilitate trade on the other;
- To protect society and the environment by implementing effective control measures to prevent smuggling of prohibited and restricted goods;
- To modernise and standardise Customs procedures so as to bring them in line with international standards and best practices;
- To collect data for compilation of statistics on foreign trade;
- To co-operate and co-ordinate with other customs administrations and law enforcement agencies; and
- To promote public trust by enhancing the integrity of Customs personnel.

The focus areas and strategic objectives set out in the Custom Reform and Modernisation Strategy are as follows:

- Implementation of modern international customs practices:
 - To Achieve Compliance with the Standards of the Revised Kyoto Convention:
 - To Introduce an Authorised Economic Operator Scheme;
 - To Introduce a Post Clearance Audit;
 - To Develop and Apply a Comprehensive and Coherent System of Risk Management in All Areas of Customs Control;
 - To Introduce an Effective System of Prevention, Deterrence, Investigation and Enforcement;
 - To Implement Controls over the Value of Imported Goods which are Fully and Consistently Compliant with the World Trade Organization's Valuation Agreement;
 - To Meet the Customs Standards in the WTO Trade Facilitation Agreement; and
 - To Develop and Introduce a Modern System of Customs Warehousing.
- Establishment of a Modern IT Environment:
 - To Establish, Staffs and Equip a New IT Division within the Department;
 - To Continue the Rollout of MACCS and MCIS;
 - To Contribute to the Development of a National Single Window;
 - To Upgrade the Myanmar Customs Department Website;
 - To Develop and Introduce a range of New IT Systems and Applications; and
 - To Develop a Myanmar Customs Intranet.
- Reforming the Organization, and Developing its Human Resources
 - To Introduce and Progressively Allocate Staff to a New Organisation Structure;
 - To Develop and Introduce Human Resource Management (HRM) Systems and Procedures which will Support the Implementation of the Strategy and Organisation Structure; and
 - To Develop and Introduce Human Resource Development (HRD) Systems and Procedures which will Support the Implementation of the Strategy and Organisation Structure.

- Creating and Nurturing Effective Partnerships:
 - To Develop Effective Relationships with the Private Sector;
 - To Develop Effective Cooperation Arrangements with Other Government Departments and Customs Administrations;

Myanmar Sustainable Development Plan (MSDP)

The draft of Myanmar Sustainable Development Plan (MSDP) has been issued in February 2018. The MSDP is conceived as an overarching national development policy framework for the government that localizes the global SDG agenda along with Myanmar's other regional and global commitments. It is also strategically linked to the development of general project screening and prioritization framework for national development projects under the rubric of the new initiative known as Public Investment Program (PIP)."

The Myanmar Sustainable Development Plan (MSDP) is founded upon the objective of giving coherence to the policies and institutions necessary to achieve genuine, inclusive and transformational economic growth. The product of the work of multiple agencies and individuals in Myanmar, and the active consultation of a myriad of stakeholders.

The Ministry of Planning and Finance (MoPF) will serve as the focal entity responsible for overseeing implementation of the MSDP, and for housing the MSDP Implementation Unit (MSDP-IU), which shall oversee the creation of necessary implementation structures, coordination frameworks and monitoring mechanisms.

The MSDP sets out an action plan for improving land governance and sustainably managing resource-based industries. Speeding up the compliance with the EITI requirements was defined as one of the actions to be implemented.

Myanmar Development Assistant Policy (MDAP), which is available online - Ministry of Information (MOI) web portal, has been prepared by the Development Assistance Coordination Unit together with the Foreign Economic Relations Department of MOPF. MDAP is the policy to implement the Sustainable Developments Goals, which are stated in the Myanmar Sustainable Development Plan.

3.5. Fiscal devolution

Under the current system, as Union government spending is recorded in the budget by sector ministry rather than by location, the total levels of Union government expenditure in each state or region are not available.⁸⁸

State and regional governments in Myanmar were created by the 2008 Constitution and set up in March 2011. Myanmar today comprises seven states and seven regions, five self-administered zones, one self-administered division, and Nay Pyi Taw as a Union territory. State and regional governments are led by chief ministers who are appointed by the President from among members of the state/region Hluttaw (parliament).

Under the 2008 Constitution, state and regional governments are empowered to enact laws and collect taxes from the extractive sector, but only for marginally significant types of operation. In each state or region, there is a unicameral Hluttaw (with two elected members per township, and 25% of the parliament sourced from the Defense Services), as well a Chief Minister and a Cabinet. The Chief Minister is selected by the President and confirmed by the Hluttaw. The sub-national Hluttaw is entitled to set its own budgets (under Article 252), based on the threshold set by the annual Union budget.

⁸⁸ The deconcentrated channel of funds for states and region departments of union ministries are not presented in national budget documents; the parent union ministry is the primary budget unit, and there is not currently a secondary budget classification that clearly breaks out state/region spending at union level. Together, these factors mean that it is currently very difficult to answer the most basic question about fiscal decentralization: how much of Myanmar's public spending is decentralized, and to what levels? (Nixon and Joeline, 2014)

Under the 2008 Constitution, subnational involvement in natural resource management and revenue collection is limited. The legislative areas and administrative responsibilities of state and region governments are listed in Schedule Two of the 2008 Constitution. Oil and gas and mining are not included in Schedule Two, with the exception of a few areas such as salt products, firewood and gemstone cutting and polishing.

Myanmar is subdivided into seven states, seven regions, five self-administered zones, one self-administered division and one union territory. Below regions and states are several layers of subnational authorities, including districts, townships, towns, villages and urban wards. These lower layers of administration have vague mandates and are controlled by the central government's General Administration Department (GAD) of the Ministry of Home Affairs (MOHA).⁸⁹

Schedule Five of the 2008 Constitution stipulates the taxes collected by states and regions. These include land and mineral taxes collected by the General Administration Department, taxes on allowed timber species and forest products collected by the Forestry Department and electricity charges from small hydropower stations.

State and regional governments may levy excise taxes, land taxes, water taxes, road tolls and taxes, and royalties on fisheries. In the extractive sector, they may only collect mineral taxes from gravel and sand producers. They may also sell or lease state or regional government property and make profits on state or regional government-owned enterprises. In practice, there is no taxes collected from extractive industries at sub-national level⁹⁰.

Self-administered zones and divisions function differently according to Schedule III of the 2008 Constitution. Revenues for self-administered zones and division are drawn from Union, regional and state budgets.

In addition to the formal decentralization process initiated by the 2008 Constitution, since 2011 the Union government has undertaken several reforms in the direction of fiscal decentralization. For instance, state and regional budgets for public services and development projects have increased substantially. In FY 2013/14, the Union allocated 3.4 percent of the national budget to state and region loans and grants. The budgeted amount increased to 7.6 percent of the budget in the FY 2014/15 and 8.7 percent of the budget, or MMK 1.8 trillion, in FY 2015/16⁹¹.

Natural resource-related payments to Union ministries or the Internal Revenue Department are not generally reported to the Ministry of Planning and Finance according to their region of derivation. A company, for example, would pay profit tax from its company headquarters to the township officer of the Internal Revenue Department, not at the site of resource extraction.

Actually, the transfers made to the regions are not based on a revenue sharing formula. The only exception to this principle has been the 5% of fiscal transfers allocated to 'development funds' which are divided on the basis of poverty incidence rates⁹²

⁸⁹ World Bank (2015) Myanmar Public Expenditure Review 2015. World Bank Group, September 2015

⁹⁰ Discussions with General Administration Department representatives

⁹¹ <https://www.mmimes.com/national-news/13864-u-thein-sein-govt-s-last-budget-approved.html>

⁹² <https://asiafoundation.org/publication/local-development-funds-in-myanmar/>

3.6. Revenues collection, revenues allocation and subsidies

3.6.1. Public financial management

The Assembly of the Union (Parliament) and the Union Government are the main entities that oversee the management of the state financial system. GoM prepares the projection of revenues and expenditures in the annual budget proposal and presents it to Parliament.

According to the Budget Law, the national budget revenue consists of tax and non-tax revenues. Non-tax revenues include:

- Receipts from the State-owned Economic Organizations;
- Current Receipts;
- Interest receipts;
- Grant receipt;
- Capital receipts;
- Receipts from Foreign Aids;
- Receipts from Investment in Organizations; and
- Receipts from saving.

In Myanmar, there is no single system for public financial management (PFM). Instead, government agencies and institutions each maintain separate systems, generating redundancy. For example, there is no internal audit system in most ministries, meaning that in many cases there is no way to verify compliance of applied process and transaction. Subnational governments are not informed of the size of fiscal transfers in a timely manner, meaning they cannot plan their budgets.

According to the World Bank's Public Expenditure and Financial Accountability (PEFA) assessment and the International Budget Partnership's Open Budget Survey, Myanmar's budgeting process has traditionally been one of the World's most opaque. Basic information regarding revenues and expenditures, debt stocks, financial assets and budget outcomes has not been disclosed to the public. Audits and contracts on large capital projects have generally remained secret.

The ongoing Modernization of Public Financial Management project—supported by the World Bank and the Australian and UK governments—is working to address many of these issues. Among the initiatives underway are:

- Establishing a Large Taxpayers' Office;
- Implementing a medium-term fiscal framework that includes the subnational level;
- Establishing a single computerized financial management system to store and organize information;
- Establishing common procurement rules and practices;
- Establishing a Public Account Committee Office to undertake independent analysis of the budget; and
- Enhancing the capacity of OAG.

3.6.2. Revenues collection

Currently, Myanmar employs a range of tax instruments. The most important are the Commercial Tax on Consumption and the Income Tax levied on both SOEs and the private sector. Together, these instruments generated around 90% of total tax revenues.

Currently, a large share of government revenues is directly or indirectly related to natural resources, in particular gas and jade. The government benefits from a broad range of revenues from extractive projects, including entitlements, royalties, allocations of shares, transport fees, transit fees, training and education funds, and income taxes. Precise figures on the total value of such revenues are available in Section 5 of this report.

Most of extractive revenues are collected in cash. Some of the revenues from extractive projects are passed on to the union government and some are retained by SOEs such as the MOGE, MGE, ME1, ME2 and ME3 as shown in graphics below.

All revenues from the extractive industry sector other than those directly collected by SOEs are recorded in the national budget. Union government revenues may be classified based on source and based on collecting department/agency, and not necessarily on the consideration expected to

be collected. The SOEs contribute to the Union's budget through two main fiscal instruments. The first is the profit tax applicable to all enterprises (both public and private) at a 25% rate. The second instrument is a form of Union Dividend, consisting in a direct transfer of 20% of the profits of SOEs to the government budget. The remaining share is either used to self-finance investment or is transferred to the Union.

a) Oil and Gas payments flow

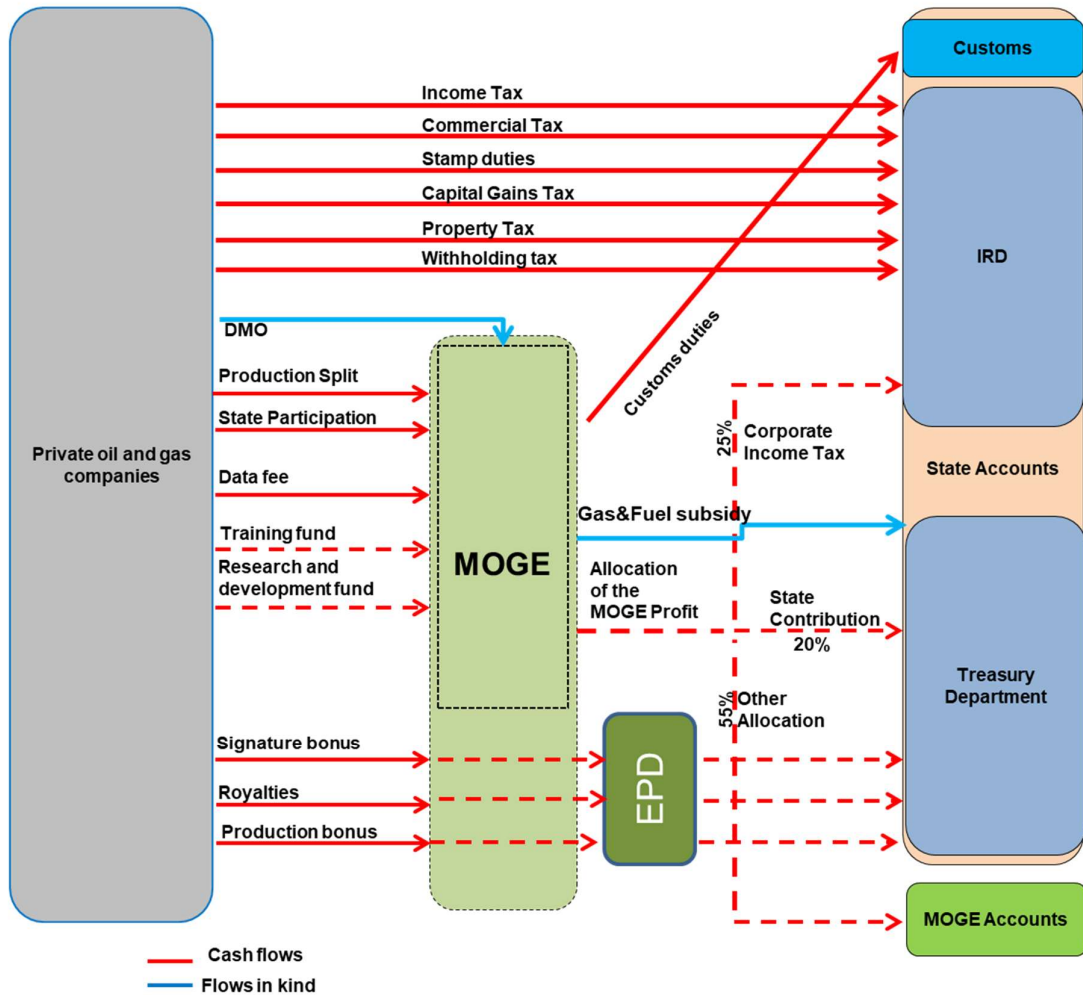

b) Transportation of Oil and Gas payments flow

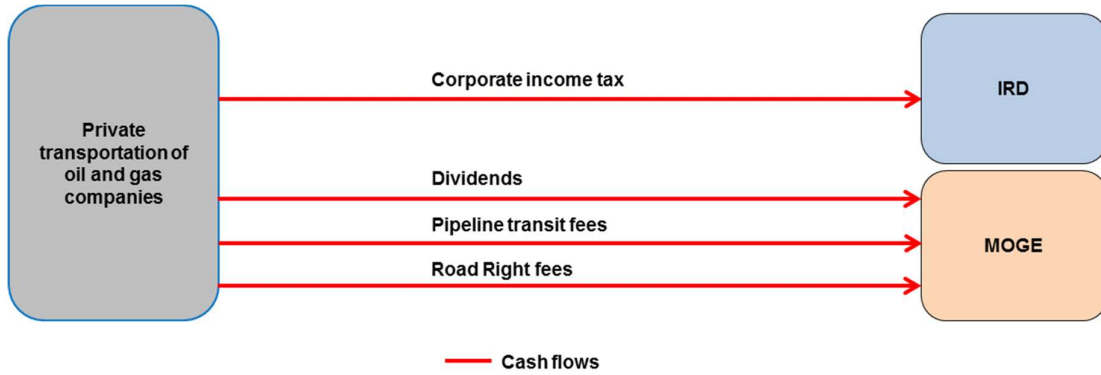

c) Mining sector payments flow

Jade and Gemstones

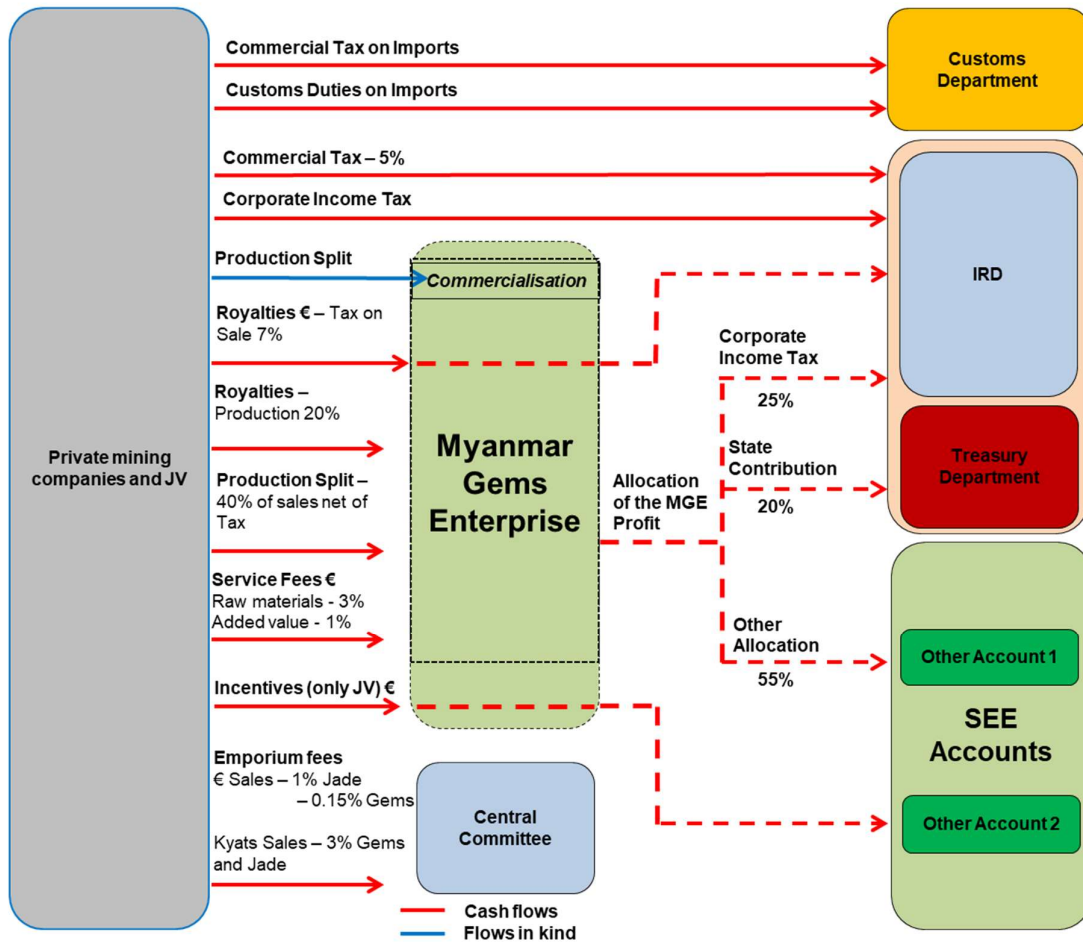

Other minerals

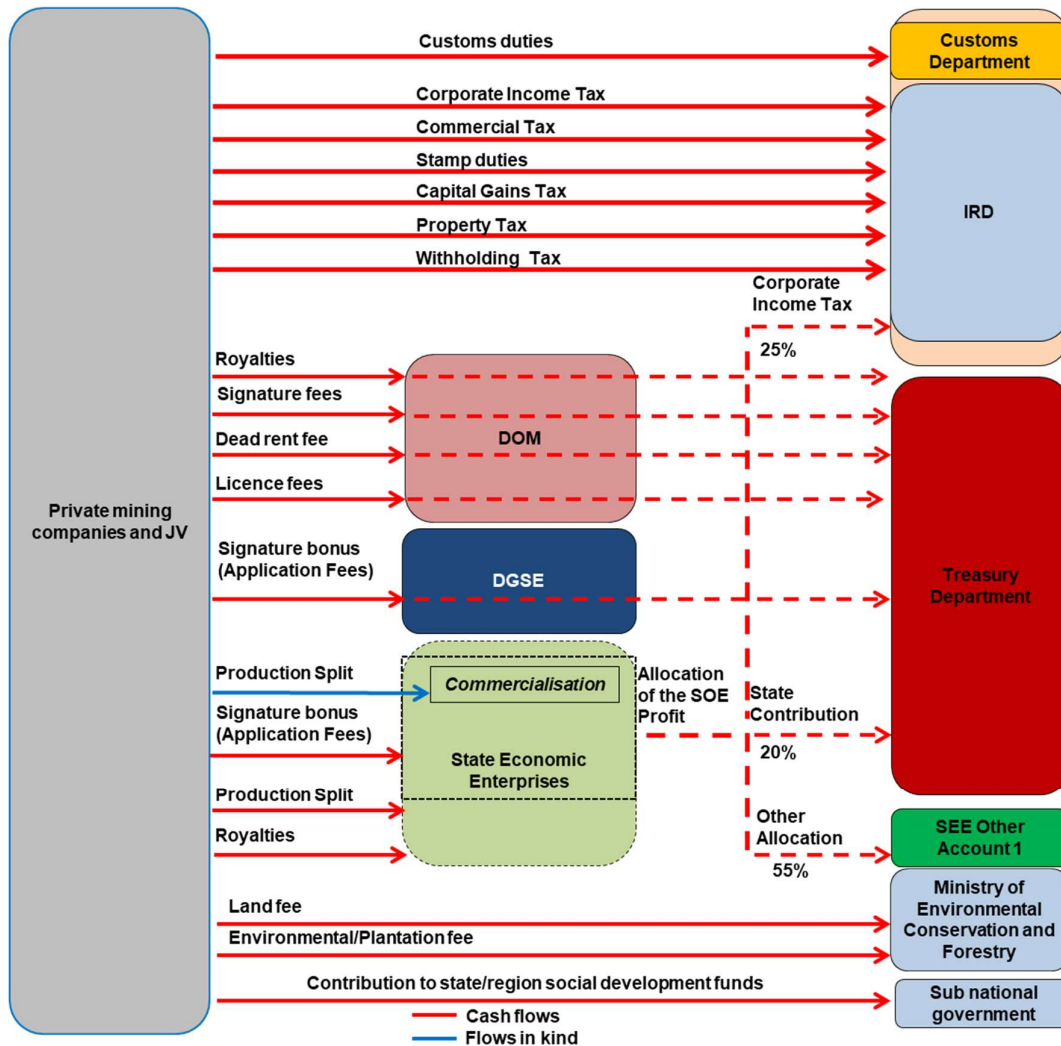

3.6.3. Revenues allocation

In the diagrams above, the Budget and Treasury Departments within the MoPF coordinate the receipt of information on the types on tax and non-taxes received from the, MoEE and MONREC respectively.

Meanwhile, IRD and Customs Department within the Ministry of Finance collects taxes such as income tax (including withholding taxes), commercial tax, capital gains tax, stamp duties and customs duties either in local or foreign currency.

All government SOEs including MOGE, Mining Enterprises 1,2,3 and the MGE, are required to submit reports about their revenue sources and expenditures in cash and in kind at the time of the budget review on an annual basis.

SOE's are in charge of collecting most non-tax revenues such, production sharing split, land fees, signature bonuses and other compulsory payments mandated by contracts as per the corresponding extractive operation.

Oil, gas and mining revenue payments in cash are transferred by the taxpayer or the contractually responsible entity to the Myanmar Economic Bank (MEB) when the payment is in national currency and to the Myanmar Foreign Trade Bank (MFTB) when it is in foreign currency. Both MEB and MFTB are state owned commercial banks and are controlled by the Central Bank of Myanmar as well as by the MoPF through its reporting line process.

Allocation of SOE other accounts

According to the EITI data, over 83% of extractive revenues, are collected by SOEs through "Other Accounts".

After the financial year 2012-2013, UFA (OA) has been allowed to open with the notification No. 547/2012 of Ministry of Planning and Finance. Since then, State Economic Enterprises have been allowed to open SEE Accounts and Other Accounts – OA. It was mainly based on two policies. One policy is to operate their business activities more commercially and the other is to be stand financially on their own. These policies were established and implemented so that SEEs will act more commercially in line with the market economic system and not be a financial burden on the State. It differs in the fact that SEE account has strict regulations for transactions and SOE OA can facilitate transactions quickly.

The SOE other account is opened at Myanmar Economic Bank and it should include all the incomes including the revenues generated the Oil&Gas and mining contracts and all the expenditures related to these contracts while calculating the profit and loss accounts in "Other accounts". For the case of the MOGE, the incurred expenditures include the oil and gas subsidies for the domestic market.

We understand that all expenditures debited on the SOE other account are submitted to the prior approval of of the Union Government to Pyidaungsu Hluttaw (Union Parliament). If SOEs need modifying their expenditures estimates as required by their operations, they can make modifications after submitting them with the agreement of the Union Government to Pyidaungsu Hluttaw (Union Parliament) for approval. We also understand that SOEs other accounts are used under the supervision of the Ministry of Planning and Finance.

After paying income tax according to the Income Tax Law, State contribution, the remaining balance of SOE "Other Accounts" can be carried forward to the next financial year. If SOEs have surplus and if they want to make these funds as financial investment, they can only invest in Treasury Bills. But they can only invest after they have already paid in full the working capital or any revolving funds borrowed from Myanmar Economic Bank, State contribution and taxes. An Economic Enterprise cannot lend the funds to another.

According to the MoPF, SOEs other account are part of the Union Fund and therefore are part of the Union Budget. Thus, SOEs other accounts are consolidated with the budget accounts and are used for the budget deficit financing which means that Other accounts surplus are in fact spent for SOEs as well as the expenditures of non-revenue making ministries such as Education, Health and Sport, Social Welfare, Relief and Resettlement.

The allocation of extractive revenues can be summarised as follows:

Oil and Gas sector

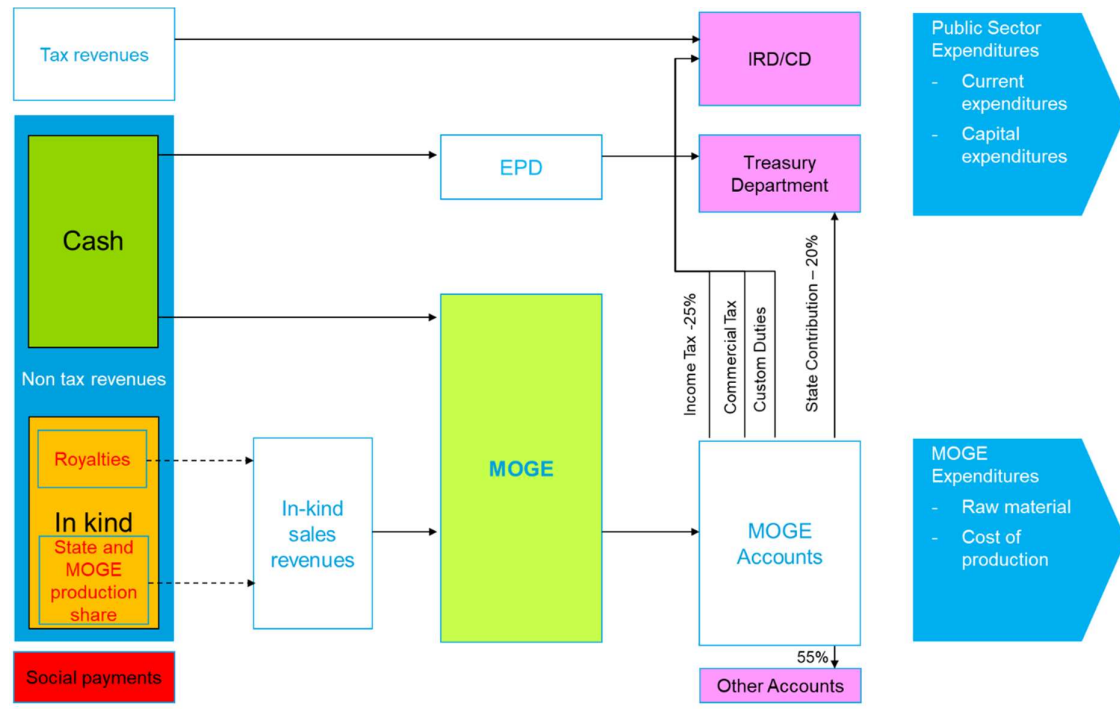

Gems and Jade sector

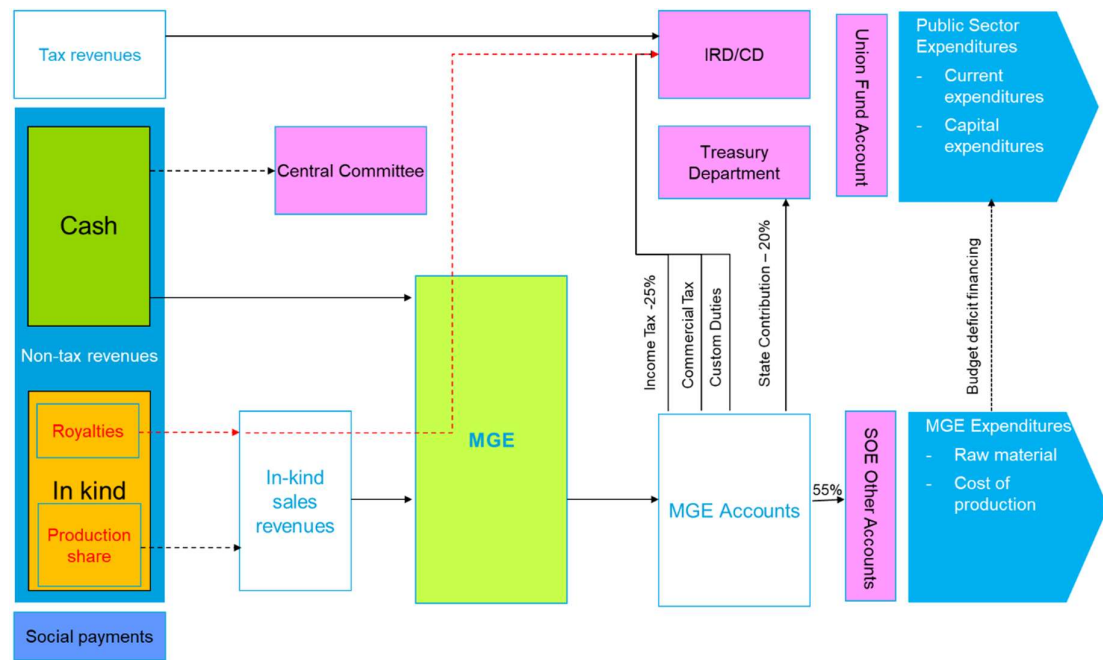

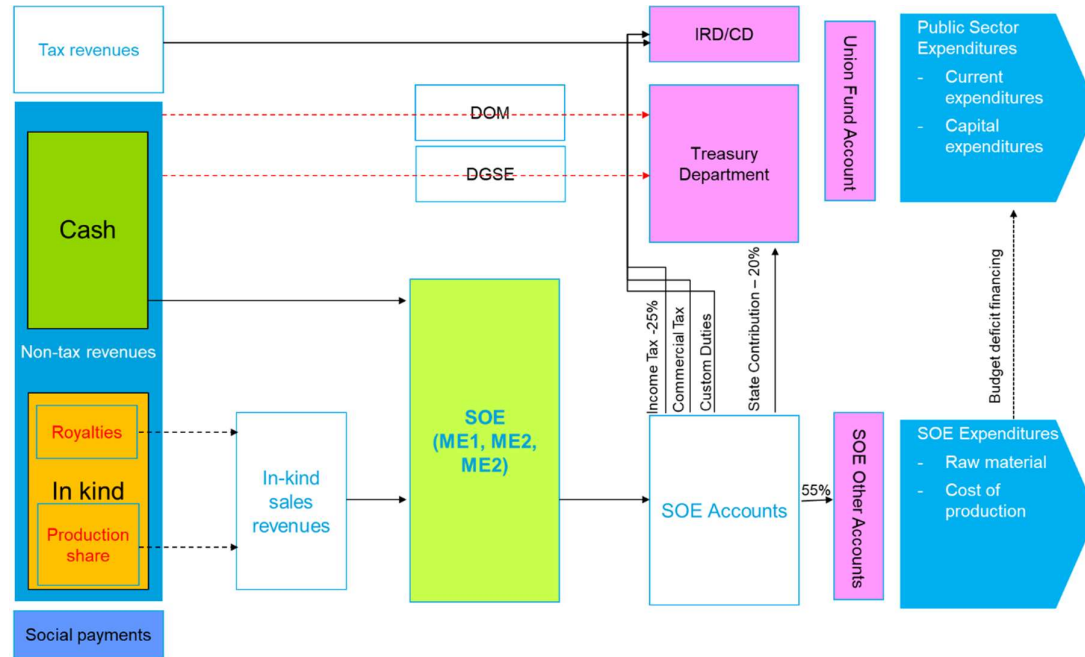
Other minerals sector**3.6.4. The Oil and Gas Subsidy**

The Oil and Gas subsidy for domestic consumption is a medium through which Oil & Gas revenues are shared with citizens. Oil and gas subsidies absorb a part of the total cost of petroleum fuels as a means of protecting consumers from high fuel/energy prices and sharing of the petroleum wealth.

Oil and Gas Subsidy is supported by both the producing companies and the Government. According to the Oil and Gas contracts, 20% of crude oil and 25% of natural gas of contractor's shares should be sold by the latter on the domestic market, at 90% of fair market prices.

The government also subsidises gasoline and other fuels by selling them locally at a price below the comparable international market price, and this subsidy is channelled through MOGE.

Myanmar Oil and Gas Enterprise (MOGE) supplies 250–300 MMCFD of natural gas to domestic consumers. Of this, about 60 MMCFD is from MOGE's onshore production. The remaining amount is from the Yadana gas field, operated by Total E&P; the Shwe gas field, by Daewoo International; and the Zawtika gas field, by PTT International. Yadana gas is priced at the same level as the export price to Thailand; Shwe and Zawtika gas is priced at the level set for the domestic market obligation. The domestic market obligation price is at a 10% discount of the contract price to foreign buyers. Consumers include EPGE for its power plants (run by both independent power producers [IPPs] and EPGE), other government industries, private industries, and compressed natural gas vehicles.⁹³

In 2014-2015 subsidies granted through MOGE, more details are set out in the Section 6.7 of the present report.

⁹³ Myanmar, Energy Sector Assessment, Strategy, and Road Map, ADB, Dec. 2016

3.7. Beneficial ownership

3.7.1. Legal and regulatory framework governing companies

The legal framework governing companies incorporated in Myanmar is the Companies Act 1914 and subsidiary legislation, Myanmar Companies Rules 1940, Myanmar Companies Regulations 1957) and Special Companies Act (1950) (if joint venture with government enterprise) (together, the “Companies Legislation”).

The Companies Legislation provides guidelines for the formation, administration, and winding up of registered corporate bodies. The Companies Legislation is expected to be reformed in the near future to include further transparency and disclosure provisions in the law.

There are various types of companies which can be formed in Myanmar; namely limited by shares, limited by guarantee and unlimited companies. Furthermore, in Myanmar a company can be classified either as a private company or a public company. A “private company” means a private company limited by shares, a company limited by guarantee or an unlimited company. On the other hand, a “public company” means a company incorporated as such, being a company satisfying §13A of the Companies Act 1914.

3.7.2. Beneficial ownership in Myanmar’s legal and regulatory framework

Disclosure requirements for private companies

The definition of “beneficial ownership” should not necessarily be linked to share ownership. Owning more than a certain percentage of shares certainly gives a meaningful indication of beneficial ownership. However, in identifying the real beneficial owner, the focus should also be on contractual and informal arrangements.

The notion of control or beneficial ownership has not been treated by the Companies Legislation and there is no requirement to disclose information about the ultimate beneficial owners.

Disclosure requirements for mining companies

There are no obligation or restrictions on the disclosure of beneficial ownership information by the Government, State Owned Enterprises and private companies under the Mining Legislation. MONREC and mining companies do not currently disclose such information publicly.

It should be noted that beneficial ownership details can be fairly sensitive information for private companies to disclose, and the mining industry in Myanmar is dominated by smaller privately-owned companies with limited experience in transparency standards.

Disclosure requirements for Oil and Gas companies

On the same terms as per the mining sector, the notions of beneficial ownership and control have not been covered by the oil and gas legislation.

Many of the private operators in the Myanmar oil and gas sector are wholly owned by listed companies which would not be subject to BO disclosure. The other main group of industry players in the Myanmar oil and gas sector are foreign government owned enterprises for which disclosure of ownership details should not present too much difficulty with regards to BO disclosure. A potential group of industry players that this reporting requirement would impact are private companies registered in Myanmar which have been set up to partner with foreign companies in the bids for onshore and shallow water offshore blocks.

Disclosure requirements for Government officials

Currently, there are no specific rules for government officials to disclose their interests, incomes or assets in/from the extractive sector.

Only the members of the Anticorruption Commission are required to disclose money, property, assets and liabilities of their respective families including beneficial ownership to the President according to the provisions of the Anticorruption law 2013.

3.7.3. Definition of Beneficial Ownership

Based on the review of Myanmar's legal framework which does not include provisions relating to the beneficial ownership definition or disclosure and taking into account EITI Requirement 2.5, the following definition of Beneficial Ownership was agreed by MSG:

Proposal for a definition of beneficial ownership

A beneficial owner is a natural person(s) who, directly or indirectly, ultimately owns or controls a public or private company or corporate entity. A person is automatically considered to be a beneficial owner if they own or control 5% or more of the public or private company or corporate entity.

- *The individual holds, directly or indirectly, 5% and above of the shares within reporting period which is 2014-2015 & 2015-2016 in the public or private company or corporate entity.*
- *The individual holds, directly or indirectly, 5% and above within reporting period which is 2014-2015 & 2015-2016 of the voting rights in the public or private company or corporate entity. Voting rights held by the public or private company or corporate entity, itself are disregarded for this purpose.*
- *The individual holds, directly or indirectly, the voting rights in the public or private company or corporate entity. Voting rights held by the public or private company or corporate entity, itself are disregarded for this purpose.*
- *The individual holds the right, directly or indirectly, to appoint or remove a majority of the board of directors of the public or private company or corporate entity.*
- *The individual has the right to exercise, or actually exercises, significant influence or control over the public or private company or corporate entity.*

Reference to "ultimately owns or controls" refer to situations in which ownership/control is exercised through a chain of ownership or by means of control other than direct control. This definition should also apply to a beneficiary under a life or other investment."

The following definition of Politically Exposed Persons (PEPs) was agreed by the MSG:

Politically Exposed Persons (PEPs)

PEPs are defined as individuals belong to one of the following categories:

- ***Domestic PEPs:*** *individuals who are or have been entrusted domestically with prominent public functions, for example, Cabinet Members at Union level & State and regional level, Members of Parliament both Union level and state and regional level, senior government (Deputy Ministers, Permanent secretaries, DGs, DDGs, Directors, Auditor General, Central Bank, etc..) , judicial or military officials including Ethnic Armed Organizations' senior leaders and officials, senior executives of state owned corporations, important political party central committee members and key influencers.*
- ***Foreign PEPs:*** *individuals who are or have been entrusted with prominent public functions by a foreign country, for example Heads of State or of government, senior politicians, senior government Officials, judicial or military officials, senior executives of state owned corporations, important political party officials and diplomats.*
- ***International organization PEPs:*** *persons who are or have been entrusted with a prominent function by an international organization, refers to members of senior management or individuals who have been entrusted with equivalent functions, i.e. directors, deputy directors and members of the board or equivalent functions, International Financial institution's leaders and senior staffs.*

PEPs shall also be defined to include:

- ***Family members*** *who are related to a PEP in one of the categories above either directly (consanguinity) or through marriage or similar (civil) forms of partnership, to the second degree of relation.*
- ***Close associates*** *who are closely connected to a PEP in one of the categories above, either socially or professionally.*

As the country moves towards compliance for this EITI requirement, a roadmap was developed by the MSG that would address the definition of beneficial ownership and the threshold or percentage of ownership to be considered material. Details of the roadmap can be found in the following link: https://eiti.org/sites/default/files/documents/bo_roadmap_-_myanmar.pdf

3.7.4. Beneficial ownership declaration

According to the above proposed definition, the companies selected in the scope were required, on a voluntary basis, to submit a beneficial ownership declaration according to the format approved by the MSG. Accordingly, the following information should be made available:

- **Name of beneficial owner.** full name(s) of the company's beneficial owner(s) and information on their identity (ies) including:
 - **Name of any politically exposed person**, where any owner is also a 'politically involved person', this should be mentioned.
 - **Identifying details.** Additional details are required in order to narrow down a beneficial owner to one individual.
- **Contact.** A means of contacting the beneficial owner such as a business address.
- **Means of control.** A description of how the beneficial owner and any politically engaged persons exercise control over the company. If there is a chain of companies between the beneficial owner and the natural resource asset, for example, this would mean the name of every company within the chain. In some cases, there may be an additional link, such as a private agreement between the beneficial owner and the owner of the last company in the chain, in which case this additional link should also be declared. Third parties should then be in a position to verify some, if not all, information declared in the shareholder registers.
- **Signed statement of accuracy:** a senior official from the company should sign a statement to confirm that the information provided is accurate.

None of the selected companies submitted its beneficial ownership declaration.

In February 2014, Global Witness sent information requests on beneficial ownership to each of the companies that were awarded Oil and Gas onshore blocks in October 2013, or which were involved in the bidding for offshore blocks. Of the 47 companies contacted, 18 provided responses to Global Witness' ownership questions. Survey results can be found in the following link: <https://www.globalwitness.org/fr/archive/real-winners-myanmars-oil-and-gas-blocks-remain-hidden/>

3.8. Audit and assurance practices in Myanmar

3.8.1. Private companies

Under the Myanmar Companies Act (MCA) companies must keep proper books of accounts at their registered office. Financial statements must be prepared in accordance with Myanmar Accounting Standards (MAS).

Accounting practices in Myanmar have been historically based on British accounting standards and Generally Accepted Accounting Principles (GAAP). For several years, Myanmar adopted International Accounting Standards for reporting purposes, while the Myanmar Accountancy Council (MAC), through the Myanmar Institute of Certified Accountants (MICPA) has adopted the majority of International Accounting Standards that existed in 2003 and 2004. In 2010, MAC withdrew all 30 of International Accounting Standards and replaced them with 29 new Myanmar Accounting Standards and 8 new Myanmar Financial Reporting Standards that were identical to the 2010 International Financial Reporting Standards (IFRS). Such standards were published in the Official Gazette and became effective on 4 January 2011.

Public companies and financial institutions are required to apply MFRS (Myanmar Financial Reporting Standards, which are a word-for-word equivalent of IFRS). SMEs must apply MFRS for Small and Medium Enterprises (SMEs) (word-for-word equivalent of IFRS for SMEs).

Recently, Myanmar Accountancy Council has signed the agreement for the Supply of Data for the Adoption and Publication of IFRS Standards between Myanmar Accountancy Council and IFRS Foundation Cooperation in order to adopt International Financial Reporting Standards (IFRS) in Myanmar. Notifications on adoption IFRS will be issued later. After issuing the notification, all Public Interest Entities (PIEs) are required to apply IFRSs from effective date.

The tax assessment year runs from 1 April to 31 March. This is mandatory even for branches of foreign companies which may have a different financial year-end.

The Myanmar Companies Act 1914 and subsidiary legislation (Myanmar Companies Rules 1940 and Myanmar Companies 18 Detailed Report Regulations 1957) (together, the Companies Legislation) govern the conduct of companies and company affairs in Myanmar today. The Companies Legislation contains annual reporting requirements for companies registered in Myanmar, including the preparation of statutory reports setting out the share capital and details of the receipts and payment of a company (Section 77 of the Companies Act) and financial reports containing balance sheets and profit and loss statements (Section 131 of the Companies Act). Such reports are required to be audited and sent to the Companies Registrar as well as members of the companies. The Companies Legislation also imposes certain auditing requirements for companies in which the Government holds shares (Section 145A of the Companies Act). The Myanmar Companies Act also requires companies to appoint an auditor and companies are required to submit audited financial statements to the tax authorities annually by 30 June.

Section 145(1) of the Myanmar Companies Act requires an auditor to report to the members of a company on the financial statements examined by the auditor at the annual general meeting. The auditor's report must state, amongst others, whether or not in their opinion the balance sheet and profit and loss account referred to in the auditor's report are drawn up in accordance with law, whether or not the balance sheet gives a true and fair view of the state of affairs of the company. The opinion should also state whether the company's accounting records have been kept by the company as required by law.

In practice, however, the financial reporting and auditing provisions of the Companies Legislation are not comprehensively or consistently applied and there is limited transparency on the financial affairs of companies in Myanmar today.

Myanmar Companies Law was enacted by the Pyidaungsu Hluttaw on December 6, 2017, replacing the Myanmar Companies Act of 1914. The requirements of Financial Reports and Audit are prescribed in Division 24 of the Law. The requirement of Repeal of certain existing Regulations and continued effect of others is prescribed in Article 471,472 of the Law.

The companies selected in the EITI scope were asked to confirm whether their financial statements for the period covered by this report had been audited. Details on the confirmations received can be found in Appendix 1.

3.8.2. Public sector and SOEs

In Myanmar there is a special Government Agency – Office of the Auditor General of the Union (OAGM) – the supreme audit institution of Myanmar, which is accountable to the President and the Parliament simultaneously. This body carries out controls over the execution of the State's budget and payment of taxes and other mandatory payments, including payments from SOEs and partners.

OAGM was set up under the 2008 Constitution as an independent agency, for the appointment of the Auditor General. This was made by the President with the approval of the Parliament.

OAGM performs audits consistent with Generally Accepted Auditing standards comparable with International Organisation of Supreme Audit Institutions (INTOSAI) audit standards.

All SOEs are required to submit bi-annual financial reports which have been prepared in accordance with Generally Accepted Accounting Standards to OAGM. According to OAGM, the annual audit includes all tax and non-tax payments made by all partners to the extractive industries sector project. Other Accounts, held by the SEEs, are state fund accounts that are audited by the OAGM, as are all the state accounts held at MEB.

We have received from the respective SOEs the following SOEs audit reports:

SOE	Period	
	From April to September 2014	From October 2014 to March 2015
MOGE	✓	✓
MGE	✓	✓
ME1	✓	✓
ME2	✓	✓
ME3	✓	✓

However, we note that these audit reports are not publicly available.

Union Auditor General has the authority to audit government ministries, SOEs and to give comment on the appointment of their Joint Ventures auditors. According to the amendment of Union Auditor General Law (2018), Union Auditor General has a duty to audit the Joint Ventures companies jointly owned by the Government if necessary. The Myanmar Economic Corporation (MEC), a military-affiliated company, remains exempt from auditing or taxation. Union Auditor General also has a duty to re audit the accounts of private companies which have been already audited by a certified public accountant and practicing accountant relating to taxes and revenues to be paid to the Union if necessary, but currently lacks the capacity and the resources to do so. OAG's effectiveness and capacity to hold government ministries, SEEs and the Parliament to account has yet to be determined, and its reports are not disclosed to the public.

OAGM sends bi-annual summary reports both to the President and the Parliament simultaneously. However, there are no penalties for delayed submissions.

The Union General is also Chairman of the Myanmar Accountancy Council which deals with accounting standards in Myanmar. Accounting standards have been developed for the commercial sector which is also applicable to SOEs in the "commercial" form of their accounts. But, to date, there are no standards or statements of practice that apply to the Government's financial statements which include SOEs activities prepared on a cash basis in parallel.

Government departments maintain their accounting system on cash basis and SOEs maintain their accounting system in accrual basis, however, the current form of the financial statements does not fully reflect the IPSAS requirements.

3.9. Contribution to the Economy

3.9.1. GDP Contribution

The most widely used indicator of how well a country is performing economically is the Gross Domestic Product (GDP). In simple terms, the GDP of a country refers to the total value of all of the goods and services produced within the borders of that country in a given year.

In fiscal year 2014-2015, the total value of goods and services produced in Myanmar stood at MMK 65,261,890.2 million⁹⁴, of which 7.4% or MMK 4,797,493⁹⁵ million was accounted for the extractive sector. This figure not include midstream, downstream and transportation contribution and available data does not allow a systematic analysis by subsectors (e.g. exploration and production, refining, petrochemicals, service contractors, transportation, distribution and production).

⁹⁴ Source: Central Statistical Organization

⁹⁵ Source: Central Statistical Organization

3.9.2. Revenues contribution

The extractive sector contributes significantly to the revenues received by the Government. EITI Data reported by government shows that in fiscal year 2014/2015, the extractive sector generated MMK 3,408,193 million, which amounted 20.6% of total Government revenue. The analysis of contribution by sector is detailed as follows:

	Amount (in million MMK)	%
Oil & Gas	2,882,206	17.43%
Gems & Jade	387,029	2.34%
Other minerals	124,848	0.75%
Pearl sector	14,110	0.09%
Total extractive sector	3,408,193	20.61%
Total budget of the Union	16,538,398	100%

We note that the contribution to the revenues above was calculated on the basis the budget revenues as per the Union Budget 2014-2015 because we were not able to obtain the actual executed revenues for 2014-2015. We note also that information about the actual executed revenues for 2014-2015 are not available online in English version.

According to the Union budget in Myanmar, revenues are organised by category such as Ministries and department revenues, State Owned Enterprises Revenues and NPT development committee and not by sector. Accordingly, there's no available data of the contribution of the extractive sector in the State revenues. The detail, by category, of the Union budget for the year 2014-2015 is as below:

Collecting Government Agency	Amount (in million MMK)	%
Ministries and department revenues	6,990,969	42.27%
Of which tax on income and property	1,664,933	10.07%
Of which tax on trade	1,291,082	7.81%
Of which tax on State Owned Enterprises	527,880	3.19%
State Owned Enterprises Revenues	9,528,935	57.62%
Of which SOE Energy	4,070,670	24.61%
Of which SOE Mines	317,681	1.92%
Other SOE	5,140,585	31.08%
NPT development committee	17,315	0.10%
Union Institutions Revenues	1,178	0.01%
Total	16,538,398	100%

Source: Union Budget Law 2014

3.9.3. Export contribution

The extractive sector accounts on average for almost 38.5% of exports earning over the period 2014-2015 with a large contribution of oil and gas subsector which accounts for over 29.5% of the total exports as shown in the table below:

	Amount (million US\$)	Amount (million MMK)	% contribution
Total Exports	12,523.71	12,464,350	100%
Extractive sector exports	6,648.07	6,616,559	53%
<i>Oil and gas</i>	<i>5,178.55</i>	<i>5,154,005</i>	<i>41%</i>
<i>Gems and Jade</i>	<i>1,027.15</i>	<i>1,022,281</i>	<i>8%</i>
<i>Other minerals</i>	<i>442.37</i>	<i>440,273</i>	<i>4%</i>

(Source: Central Statistical Organization)

It is worth noting that export statistics published by CSO above are different from those reported by SOE's in their reporting templates. Details of export figures reported are set out in the Section 6.1 of the present report.

3.9.4. Labour Contribution

We did not find any recent statistic concerning the employment by sector in Myanmar during the period covered by the present report. (See recommendation n°7). The only statistic available was the total employment in Myanmar in 2014-2015 is 21,24 million⁹⁶.

According to reporting instructions approved by MSG, companies selected in the scope have reported the number of employees. The detail by sub-sector is set out in the table below:

Sub-sector	Average number of direct local employees	Average number of direct foreign employees	Average number of direct employees
Extractive companies	23,778	1,443	26,334
Oil and Gas	2,247	256	2,959
Oil and Gas transportation	261	26	287
Gems and Jade	10,389	0	10,942
Other minerals	10,881	1,161	12,146
SOEs	0	0	10,980
MOGE			9,441
MGE			642
ME1+ME-3			349
ME2			548
Total	23,778	1,443	37,314

Due to the lack of statistics, only data reported by selected companies was used for the estimation the labour contribution of the extractive sector. The selected companies employ directly about 37,314 people representing 0.2% of total employment in 2014-2015.

⁹⁶ Source: Central Statistical Organization

4. DETERMINATION OF THE RECONCILIATION SCOPE

4.1. Selection of payment flows

The financial flows to be included in the reconciliation and the Government Agencies and companies which were required to report were determined by the MSG based on the scoping study performed before the reconciliation work.

The description of each payment flow detailed as follows, are set out in Appendix 9 of this report.

4.1.1. Common law taxes

The Internal Revenue Department (IRD) and Custom Department (CD) within MoPF are responsible for the collection of tax revenue streams. The list of taxes collected by IRD and CD from the extractive sector (Oil and Gas and mining) and identified through the review of regulations and the interviews held with Government Agencies is as follows:

N°	Payment flows (IRD)
1	Commercial Tax
	Income Tax
2	2.1 Capital Gains Tax
	2.2 Withholding Tax
N°	Payment flows (Customs)
1	Customs duties
2	Commercial Tax

The MSG has decided to include all the identified tax revenue streams in the scope for the 2014-2015 EITI Report without applying a materiality threshold.

4.1.2. Non-tax revenue streams for the Oil and Gas sector

The non-tax revenue streams determined to be within the scope of the 2014-2015 MEITI Report by the MSG are those payments made to the MOGE. The MSG has decided to include all the non-tax revenue streams in the scope of the 2014-2015 EITI Report without applying a materiality threshold.

Based on the above, the payments below were selected in the scope of the 2014-2015 Report:

N°	Payment flows
1	Signature Bonus
2	Royalties
3	Production Split
4	Production Bonus
5	State Participation
6	Baseline payment (IPR/PCC)
7	Risk compensation (IPR/PCC)
8	Payment out of production (-)
9	Dividend
10	Training Fund
11	Research and Development Fund
12	Domestic Market Obligation (DMO)
13	Data fee
14	Land fees/Dead rent fee

4.1.3. Non-tax revenue streams for the Oil and Gas transportation sector

The non-tax revenue streams determined to be within the scope of the 2014-2015 MEITI Report by the MSG are those payments made to the MOGE. The MSG has decided to include all the non-tax revenue streams in the scope of the 2014-2015 EITI Report without applying a materiality threshold.

Based on the above, the payments below were selected in the scope of the 2014-2015 Report:

N°	Payment flows
1	Profit Sharing Oil and Gas transportation
2	Transit fees Oil and Gas transportation
3	Road right fee Oil and Gas transportation

4.1.4. Non-tax revenues streams for the Gems and Jade sector

The non-tax revenue streams determined to be within the scope of the 2014-2015 MEITI Report by the MSG are those payments made to MGE. The MSG has decided to include all the non-tax revenue streams in the scope of the 2014-2015 EITI Report without applying a materiality threshold.

Based on the above, the payments below were selected in the scope of the 2014-2015 Report:

N°	Payment flows
1	Commercial Tax (*)
2	Sale Split
3	Royalty on Sale - 7%/
4	Royalty on Production - 20%
5	Permit Fee (*)
6	Service Fees - 3%
7	Emporium Fees - 1%
8	Incentive - 1%, 1.25%, 1.5% 2% (*)

(*) New payment flow, not included in the reconciliation scope of 2013-2014 MEITI report

4.1.5. Non-tax revenues streams for the other minerals sector

The non-tax revenue streams determined to be within the scope of the 2014-2015 MEITI Report by the MSG are those payments made to ME1, ME2 and ME3. The MSG has decided to include all the non-tax revenue streams in the scope of the 2014-2015 EITI Report without applying a materiality threshold.

Based on the above, the payments below were selected in the scope of the 2014-2015 Report

N°	Payment flows
1	Royalties
2	Signature Bonus / Application Fees (*)
3	Production Split
4	Dead Rent Fees
5	Land fees
6	Environmental Conservation Fees to Forest Department
7	Licence Fees

(*) New payment flow, not included in the reconciliation scope of 2013-2014 MEITI report

4.1.6. In kind payments

The EITI Standard requires disclosure of the sale of the State's share of production or other revenues collected in kind where such flows are material. This includes transfers between State-owned enterprises and other Government Agencies.

As recommended by the Standard, the MSG required that these flows should form part of the reconciliation and templates were issued to Government, State-owned enterprises and companies. The PSCs in Oil and Gas and mining sectors permit the Government to receive certain payments in kind or in cash, as follows:

- Sale of the State's share of production or other revenues collected in kind; and
- Royalty oil and gas and mining: MOGE under MoEE and MEs under the MONREC may choose to receive royalty in kind or to nominate an amount under an agreement with the producing company.

The in-kind payments included in the 2014-2015 MEITI Report scope were:

N	In kind payments for oil and gas	In kind payments for mining sector
1	State production entitlement	Production Split (Government and SOEs share)
2	MOGE production entitlement	Royalties
3	Royalties	
4	Baseline payment (IPR/PCC)	
5	Risk compensation (IPR/PCC)	
6	Payment out of production (-)	

For the sale of the State's Share of production, the MSG decided to disclose the revenues received by SOEs without reconciling with the trading companies.

4.1.7. Transfers from SOEs to the MoPF

According to the MSG decision, the revenue streams in scope for reconciliation include all the transfers made or reported SOEs and revenues received by or reported to the Government Agencies during the fiscal year 2014-2015, accordingly the payments below have been selected in the reconciliation scope:

N°	Transfers from MOGE
Transfers to budget accounts	
1	Income Tax (IT)
2	Commercial Tax
3	Customs Duties
4	Stamp Duties
5	Capital Gains Tax
6	Withholding tax
7	State contribution
8	Signature Bonus
9	Royalties
10	Production bonus
11	Other material transfers (> 50,000 USD)
Other accounts - MOGE Other Accounts	
12	Transfers to MOGE other accounts (+)
13	Transfers from the Government Budget to MOGE (-)

N°	Transfers from MGE
Transfers to budget accounts	
1	Income Tax (IT)
2	Commercial Tax
3	Royalties on Sales
4	Royalties on Production
5	State Contribution
6	Other material transfers (> 50,000 USD)
Other accounts - MGE Other Accounts	
7	Transfers to MGE other accounts (+)
8	Transfers from the Government Budget to MGE (-)

N°	Transfers from ME1, ME2, ME3
Transfers to budget accounts	
1	Income Tax (IT)
2	Commercial Tax
3	State Contribution
4	Royalties
5	Signature Bonus/ Application Fees
6	Production Split
7	Dead Rent Fees
8	Licence Fees
9	Other material transfers (> 50,000 USD)
Other accounts - SEEs Other Accounts	
10	Transfers to other accounts (+)
11	Transfers from Government Budget to MONREC, Department of Mines, ME1, ME2, ME3 (-)

4.1.8. Other information

Social payments and infrastructure provisions

Companies were asked to disclose any social expenditures and infrastructure provisions. According to the MSG decision, these payments were declared by the companies and were not included in the flows to be reconciled.

Other significant payments flows

To avoid omissions that may be considered significant, MSG has decided to include a separate line entitled "Other significant payments flows" in the reporting template for extractive companies to report any significant payment exceeding USD 50,000 including any payment flows which are not shown in the reporting template.

Quasi fiscal expenditures

According to the MSG decision, Government Agencies and SOEs selected in the scope were asked to disclose any quasi fiscal expenditures. These payments were declared by Government Agencies and SOEs and were not included in the flows to be reconciled.

Loans /Loan guarantee granted to Entities operating in extractive sector

EITI requirement 3.6 (c) states where the government and SOE (s) have provided loans or loan guarantees to mining, Oil and Gas companies operating within the country, details on these transactions should be disclosed in the EITI Report. Accordingly, the MSG has decided to disclose loans /loan guarantee granted by SOE's to entities operating in the extractive sector.

4.2. Selection of reporting entities

4.2.1. Selection of Oil and Gas and transportation companies

Oil and Gas companies

The MSG decided to include all the operators and partners in producing fields and exploration companies without applying a materiality threshold.

On this basis, 36 Oil and Gas companies were included in the reconciliation scope for the EITI Report 2014-2015. These companies are presented as follows:

		Company
SOE	1	MOGE (*)
	2	Petronas Carigali Hong Kong Ltd (PCML) (*)
	3	TOTAL (*)
Operators in producing fields	4	Daewoo International Corporation (*)
	5	Goldpetrol Co Ltd (*)
	6	MPRL E&P Pte Ltd (*)
	7	Nippon Oil (*)
Partners in the producing fields	8	PTTEP International Ltd.
	9	ONGC Videsh Ltd (*)
	10	Gail JJ India Ltd (*)
	11	Korea Gas Corporation (*)
	12	Unocal Myanmar Offshore Co., Ltd (*)
Operators in exploration phase	13	Petronas Carigali Myanmar Inc (PCMI) (*)
	14	Geopetrol International Holding Inc
	15	Jubilant Oil & Gas Pte.Ltd
	16	PTTEP South Asia Ltd
	17	IsTech Energy EP5 Pte
	18	Asia Orient International Ltd
	19	CNPC International Ltd
	20	SNOG Pte Ltd (*)
	21	Eni Myanmar BV
	22	Central Asia Oil and Gas (CAOG) Pte. Ltd
	23	Pacific Hunt Energy Corporation
	24	Bashneft International B.V
	25	Brunei National Petroleum Co
	26	Petrovietnam Exploration Production Corporation
Operators awarded O&G Blocks in 2014 and 2015 (in Study phase)	27	Oil India Ltd
	28	Ophir Myanmar Ltd
	29	Barlanga Myanmar Pte. Ltd.
	30	Shell Myanmar Energy Pte.Ltd
	31	BG Exploration & Production Myanmar Pte. Ltd.
	32	Woodside Energy (Myanmar) Pte. Ltd.
	33	CFG Energy Pte.Ltd.
	34	Reliance Industries Ltd
	35	Statoil Myanmar Pte. Ltd.
	36	Tap Energy Pte. Ltd.

(*) Included in the MEITI reconciliation scope 2013-2014

Oil and Gas transportation companies

Given the limited number of companies in Oil and Gas transportation sector, MSG decided to include all the operators in the reconciliation scope without applying a materiality threshold.

On this basis, five oil and gas transportation companies were included in the reconciliation scope of the EITI Report 2014-2015. These companies are presented as follows:

N°	Company
1	Andaman Transportation Limited (ATL)
2	Moattama Gas Transportation Company (MGTC)
3	Taninthayi Pipeline Company (TPC)
4	South-East Asia Gas Pipeline Co (SEAGP)
5	South East Asia Crude Oil Pipeline Co, Ltd (SEACOP)

4.2.2. Selection of mining companies

Gems and Jade

The MSG identified 72 companies to be included in the reconciliation process for the 2014-2015 MEITI Report. The companies listed in table below meet the materiality threshold of **MMK 0.75 billion** revenues collected in FY 2014-2015 and were included in the reconciliation process.

2014/15	Threshold (in bn Ks)	Cov by Gov Ag	Overall Cov	Nbr entities
MONREC	0.75	72%		
IRD	0.75	52%	70%	72
CD	0.75	85%		

For companies which have made payments below **MMK 0.75 billion**, the MSG decided to include through unilateral disclosure by Government Agencies of the combined benefit stream from the companies.

The MSG has also decided to include all payments and transfers made by the MGE to the MoPF regardless of whether they are recorded in the budget accounts or in off-budget accounts.

Gems and Jade companies proposed for the reconciliation scope 2014-2015	
Myanmar Win Gate Gems & Jewellery Mining	Khun Pa-Oh Gems & Jewellery
Sein Lom Taung Tan Gems Ltd. (*)	Kachin National Development
Yar Za Htar Ne Gems Co;Ltd. (*)	Silver Elephant Gems
Myanmar Imperial Jade(Gems & Jewellery) (*)	Myo Nwe Gems & Jewellery
Wai Aung Gabar Gems Co; Ltd. (*)	Shining Star Light Gems & Jewellery (*)
Ayar Jade Co; Ltd.	Myanma Seinn Lei Aung Gems
Myat Yamon Gems Co;Ltd. (*)	Myanmar Naing Group
Kyauk Seinn Nagar (Gems) (*)	Pho Thar Htoo Gems Co; Ltd.
Myanmar Sithu Jewellery (*)	RUBY DRAGON JADE & GEMS Co.,Ltd
Linn Lett Win Yadanar Gems (*)	Thi Raw Mani Gems & Jewellery (*)
Yadanar Taung Tann Gems (*)	Kan Par Ni Gems & Jewellery Co.,Ltd.
Khin Zaw Aung & Brothers Gems & Jewellery (*)	Golden Grate Wall Gems Co., Ltd
Shwe Gaung Gaung Gems	Kyauk Gyi Gone Gems & Jewellery Co., Ltd
Xie Family (*)	Phar Kant Yar Zar Gems & Jewellery Co.,Ltd
Great Genesis Gems Co; Ltd. (*)	Zwe Htet Lwin Gems & Jewellery Co.,Ltd
Richest Gems Co;Ltd. (*)	Lin Yaung Phyar Gems Co.,Ltd
Kyaing International Gems (*)	Kaung Wai Yan Gems Co,Ltd
Phyo Thiha Kyaw Gems	Yadanar San Shwin Gems Co., Ltd
Myanma Gon Yi Gems & Jewellery	SHWE BYAIN PHYU CO
Kyaw Naing & Brothers	NILAR YOMA TRADING
Kyay Sin Phyu	Jade Mountain Gems Co;Ltd. (*)
HTOO JEWELLERY CO.,LTD.	Ever Winner Gems (*)
Ngwe Hein Htet Gems & Jewellery	Than Lwin Aye Yar Gems Co., Ltd.
Lyan Shan Jewellery Co; Ltd.	Jade Padathar Gems + Shwe Gaung Gaung Gems
Yadanar Pyi Phyo Aung Gems And Jewellery Co; Ltd.	Khine Myanmar Gems Co;Ltd.
PAING PHYO THIIHA GEMS	Kan Pwint Oo
EIGHTY THOUSAND GEMS & JEWELLERY Co;Ltd	KHA YANN MYAY GEMS
Tun Naing Aung Gems	Kyay Lin
U Kyaw Min Naing(private)	Kyaw Thet Aung
Chaow Brothers Gemstone	Thirawmani Gems & Jewellery Co.,Ltd
Mann Ayer Family Co.,Ltd.	Aung Hein Min Gems Co.,Ltd
(1.1.1) Gems & Jewellery (*)	YadanarYaungChi Gems Co,Ltd
Oo Ya Gems & Jewellery Co;Ltd.	Yadanar Kaung Kin Gems & JewelleryCo;Ltd

Gems and Jade companies proposed for the reconciliation scope 2014-2015

Yaza Htarne	Big Jade Gems Co.,Ltd.
Myanmar Economics Corporation	Golden Wallet Jewellery Co.,Ltd
Pang Huke Duwa Co; Ltd.	Tun Tauk Sa Gems Co.,Ltd.

(*) Included in the MEITI reconciliation scope 2013-2014**Other minerals**

In the materiality decision adopted by the MSG, 29 companies were to be required to report payments to Government for the 2014-2015 Report. These companies meet the one of the following materiality thresholds:

- **MMK 0.25 billion** of total revenues collected by SOEs and Government Agencies in fiscal year 2014-2015; or
- **80 MT** of in-kind payments (Tin/ Tungsten Mixed Ore) collected by ME2 in fiscal year 2014-2015.

Further, Given the limited number of companies which made in-kind payments (Gold) to ME2, MSG decided to include all the operators in the reconciliation scope without applying a materiality threshold.

For companies which have made payments below the materiality thresholds above, MSG decided to include them through unilateral disclosure of Government Agencies of the combined benefit stream from the companies in accordance with EITI Requirement 4.2.b.

The MSG has also decided to include all payments and transfers made by the SOE's (ME 1, ME 2 and ME 3) to the MoPF regardless whether they are recorded in the budget accounts or in off-budget accounts.

The companies selected in the reconciliation scope for the 2014-2015 MEITI Report are listed below:

N°	Company	Type of mineral
1	Myanmar CNMC Nickel Co; LTD (*)	Ferronickel
2	Myanma Economic Corporation	Copper/Gypsum
3	Ruby Dragon Mining Co., Ltd.	Gypsum
4	Shwe Taung Mining Co., Ltd.	Lime Stone Coal
5	NgweYi Palae Mining Co.,Ltd (*)	Lime Stone
6	Win Myint Mo Industries Co.,Ltd (*)	Lead /Zinc concentrate
7	Tha Byu Mining Co.,Ltd (*)	Antimony Ore
8	GPS Joint Venture Co., Ltd. (*)	Lead Concentrate
9	Electrum Mining Co; Ltd	Iron
10	Max Myanmar Industry Co.,Ltd (*)	Lime Stone
11	Htoo International Industrial Gorup Co.,Ltd	Lime Stone / Coal
12	Tun Thwin Mining Co., Ltd	Coal
13	Shwe Moe Yan Co.,Ltd	Lead/Ore
14	Myanmar Yang Tse Copper Ltd (*)	Copper
15	Sea Sun Star Mining Production & Marketing Co.,Ltd	Gold
16	Eastern Mining Co.,Ltd	Tin & Tungsten
17	Swan Yadanar Htay Mining Co;Ltd	Gold
18	Swan Min Htet Mining Co;Ltd	Gold
19	Aung Brother Mining Co;Ltd	Tin & Tungsten
20	Eternal Mining Co., Ltd (*)	Gold
21	National Prosperity Gold Production Group Ltd.	Gold
22	Geo Asia Industrial and Mining Co., Ltd.	Gold
23	Myanmar Golden Point Family Co., Ltd.	Gold
24	THAN TAW MYAT CO,LTD	Lime Stone
25	BAGAN BUSINESS GROUP	Antimony
26	Delco Co.,Ltd (*)	Tin/ Tungsten Mixed Ore
27	Myanmar Pongpipat Co.,L td (*)	Tin/ Tungsten Mixed Ore
28	Kayar Mine Production Co., Ltd	Tin/ Tungsten/Sheelite/Mixed
29	Ye Htut Kyaw Mining Co.,Ltd	Tin/Tungsten Sheelite/Mixed

(*) Included in the MEITI reconciliation scope 2013-2014

4.2.3. Selection of Government Agencies

The MSG determined that Departments under the MoPF and MONREC and the SOEs under the MoEE and the MONREC that receive extractive-related revenues from companies are in-scope and included for reporting and reconciliation. Based on these criteria, the MSG has identified the following Government Agencies to be in-scope for the MEITI reconciliation:

Government Agencies
Ministry of Electricity and Energy (MoEE)
1. OGPD (formely EPD)
Ministry of Natural Resources and Environmental Cosnervation (MONREC)
2. DOM
3. DGSE
4. Forest Department
Ministry of Planning and Finance (MoPF)
5. IRD
6. Customs Department
7. Budget Department
8. Treasury Department
SOEs
1. Myanmar Oil and Gas Enterprise (MOGE)
2. N°1 Mining Enterprise (ME1)
3. N°2 Mining Enterprise (ME2)
4. N°3 Mining Enterprise (ME3)
5. Myanmar Gems Enterprise (MGE)
6. Myanmar Pearl Enterprise (MPE)
Central Committee

5. RECONCILIATION RESULTS

We present below detailed results of the reconciliation exercise, as well as differences noted between amounts paid by extractive companies and amounts received by Government Agencies. We have highlighted the amounts initially reported and the adjustments made following our reconciliation work, as well as the final amounts and unreconciled differences.

5.1. Payments of Oil & Gas companies

5.1.1. Cash flows reconciliation by company

The tables below summarise the differences between the payments reported by extractive companies and receipts reported by Government Agencies.

The tables include consolidated figures based on the reporting templates prepared by each extractive company and Government Agency, adjustments made by us following our reconciliation work and residual, unreconciled differences.

Amounts in MMK

N°	Company	Per Company			Per Government			Final difference
		Original	Adjust	Final	Original	Adjust	Final	
1	Petronas Carigali Hong Kong Ltd (PCML)	803,110,833,519	(46,680,497,990)	756,430,335,529	760,075,420,909	(3,699,698,052)	756,375,722,857	54,612,672
2	TOTAL	888,238,683,383	(1,019,256,887)	887,219,426,495	545,158,556,855	396,307,811,912	941,466,368,766	(54,246,942,271)
3	Daewoo International Corporation	348,881,393,925	49,297,635,933	398,179,029,859	348,732,104,901	49,446,924,958	398,179,029,859	-
4	Goldpetrol Co Ltd	7,457,777,104	-	7,457,777,104	7,358,665,126	-	7,358,665,126	99,111,978
5	MPRL E&P Pte Ltd	1,000,392,963	-	1,000,392,963	1,000,392,963	-	1,000,392,963	-
6	Nippon Oil	-	-	-	11,938,845,668	-	11,938,845,668	(11,938,845,668)
7	PTTEP International Ltd.	228,135,861,857	(43,796,602,230)	184,339,259,627	1,091,699,496	183,247,560,136	184,339,259,633	(5)
8	ONGC Videsh Ltd	-	-	-	-	-	-	-
9	Gail JJ India Ltd	-	-	-	-	-	-	-
10	Korea Gas Corporation	-	-	-	-	-	-	-
11	Unocal Myanmar Offshore Co., Ltd	21,516,984,100	-	21,516,984,100	21,155,045,972	-	21,155,045,972	361,938,128
12	Petronas Carigali Myanmar Inc (PCMI)	18,265,921,853	-	18,265,921,853	26,222,216,925	-	26,222,216,925	(7,956,295,072)
13	Geopetrol International Holding Inc	250,064,092	-	250,064,092	-	-	-	250,064,092
14	Jubilant Oil & Gas Pte.Ltd	-	-	-	-	-	-	-
15	PTTEP South Asia Ltd	763,062,528	-	763,062,528	763,062,528	-	763,062,528	-
16	IsTech Energy EP5 Pte	-	-	-	-	-	-	-
17	Asia Orient International Ltd	-	-	-	-	-	-	-
18	CNPC International Ltd	-	-	-	-	-	-	-
19	SNOG Pte Ltd	746,445,122	-	746,445,122	-	-	-	746,445,122

N°	Company	Per Company			Per Government		Final difference	
20	Eni Myanmar BV	-	-	-	-	-	-	
21	Central Asia Oil and Gas (CAOG) Pte. Ltd	-	-	-	-	-	-	
22	Pacific Hunt Energy Corporation	-	-	-	-	-	-	
23	Bashneft International B.V	-	-	-	-	-	-	
24	Brunei National Petroleum Co	-	-	-	-	-	-	
25	Petrovietnam Exploration Production Corporation	-	-	-	-	-	-	
26	Oil India Ltd	-	-	-	-	-	-	
27	Ophir Myanmar Ltd	-	-	-	281,976	-	281,976	
28	Barlaga Myanmar Pte. Ltd.	-	-	-	-	-	-	
29	Shell Myanmar Energy Pte.Ltd	-	-	-	-	-	-	
30	BG Exploration & Production Myanmar Pte. Ltd.	-	-	-	-	-	-	
31	Woodside Energy (Myanmar) Pte. Ltd.	-	-	-	-	-	-	
32	CFG Energy Pte.Ltd.	-	-	-	-	-	-	
33	Reliance Industries Ltd	-	-	-	-	-	-	
34	Statoil Myanmar Pte. Ltd.	-	-	-	-	-	-	
35	Tap Energy Pte. Ltd.	-	-	-	-	-	-	
Total payments		2,318,367,420,446	(42,198,721,174)	2,276,168,699,272	1,723,496,293,319	625,302,598,954	2,348,798,892,273	(72,630,193,001)

5.1.2. Cash flows reconciliation by revenue stream

The table below shows the total Basic Payments reported by extractive companies and Government Agencies, taking into account all adjustments:

Amounts in MMK

N°	Description of payment	Per company			Per Government			Final difference
		initial	Adjust	Final	initial	Adjust	Final	
Payments in cash								
	MoPF-IRD-Customs Department	179,440,483,776	(45,246,415,996)	134,194,067,780	109,875,899,555	38,918,358,823	148,794,258,378	(14,600,190,598)
1	Income Tax (IT)	151,111,793,252	(45,246,415,996)	105,865,377,256	100,425,947,177	24,913,079,998	125,339,027,175	(19,473,649,918)
2	Commercial Tax	-	-	-	-	-	-	-
3	Stamp Duties	96,700,000	-	96,700,000	-	96,700,000	96,700,000	-
4	Capital Gains Tax	-	-	-	-	-	-	-
5	Withholding tax	28,092,200,265	-	28,092,200,265	9,449,952,378	13,851,384,519	23,301,336,897	4,790,863,367
6	Commercial Tax on Imports	124,227,170	-	124,227,170	-	55,271,995	55,271,995	68,955,176
7	Customs Duties on imports	15,563,089	-	15,563,089	-	1,922,312	1,922,312	13,640,777
8	Other significant payments (> 50,000 USD)	-	-	-	-	-	-	-
	MOGE	2,138,926,936,670	3,047,694,822	2,141,974,631,492	1,613,620,393,764	586,384,240,131	2,200,004,633,894	(58,030,002,402)
9	Signature Bonus	746,445,122	-	746,445,122	-	-	-	746,445,122
10	Royalties	383,031,559,273	2,308,317,075	385,339,876,348	358,945,103,926	34,106,590,970	393,051,694,896	(7,711,818,548)
11	Production Split (State share- Gas&Oil sales)	1,466,220,768,871	(110,398,841,730)	1,355,821,927,141	901,795,559,016	501,970,822,142	1,403,766,381,158	(47,944,454,017)
12	Production Bonus	3,483,410,569	1,018,800,000	4,502,210,569	4,502,210,569	-	4,502,210,569	-
13	MOGE share (Profit and Cost- G&O sales)	283,137,665,968	111,387,491,404	394,525,157,372	347,437,617,301	50,306,827,019	397,744,444,320	(3,219,286,948)
14	Dividend	-	-	-	-	-	-	-
15	Training Fund	447,453,045	(348,341,057)	99,111,988	-	-	-	99,111,988
16	Research and Development Fund	-	-	-	-	-	-	-
17	Domestic Market Obligation (DMO) (-)	-	-	-	-	-	-	-
18	Data fee	939,902,951	-	939,902,951	939,902,951	-	939,902,951	-
19	Land fees/Dead rent fee	-	-	-	-	-	-	-
20	Other material payments (> 50,000 USD)	919,730,871	(919,730,871)	-	-	-	-	-
	States/regions	-	-	-	-	-	-	-
21	Contribution to the State/region social development fund	-	-	-	-	-	-	-
	Total payments in cash	2,318,367,420,446	(42,198,721,174)	2,276,168,699,272	1,723,496,293,319	625,302,598,954	2,348,798,892,273	(72,630,193,001)

5.1.3. Unreconciled discrepancies

Following the adjustments made (see Appendix 3), the total unreconciled discrepancies amounted to MMK (72,630,193,001) representing (3.09%) of total payments reported by Government Agencies. This is the sum of positive differences of MMK 5,719,016,430 and negative differences of MMK (78,349,209,430). These unreconciled differences are summarised below:

Reasons for differences	Amount in MMK
Cut-off error	(58,875,559,709)
Reporting template not submitted by the extractive company	(11,938,845,668)
Tax not reported by the extractive company	(7,956,295,072)
Tax not reported by the Govt Agency	6,145,729,462
Not material difference	(5,222,014)
Total Differences	(72,630,193,001)

(a) Cut-off errors

In fact, Oil and Gas companies pay the taxes before the end of March and flag receipts are issued in April due to the lengthy process between the transfer date and the date of the receipt. This is explained by the fact that the transfers in USD are made to Myanmar Economic Bank (MEB) and then MOGE receive the equivalent in MMK in its own bank account. Accordingly, companies reported final tax payments for the year 2013-2014 which were paid in March 2014. However, MOGE reported final tax payment of the year 2014-2015 according to the date of receipt of the transfer from MEB.

These differences relate to "Total" and are detailed by tax in the table below:

Tax	Amount in MMK
MOGE share (Profit and Cost- G&O sales)	(3,219,286,894)
Production Split (State share- Gas & Oil sales)	(47,944,454,280)
Royalties	(7,711,818,535)
Total Differences	(58,875,559,709)

(b) Reporting template not submitted by the extractive company

This difference is related to Income Tax (IT) declared by IRD as a payment from "Nippon Oil". However, the company failed to submit a reporting template.

(c) Tax not reported by the extractive company

This difference is related to Income Tax (IT) declared by IRD as a payment from "Petronas Carigali Myanmar Inc (PCMI)" for **MMK 7,956,295,072**.

(d) Tax not reported by Government Agency

This difference is related to taxes declared by Oil and Gas companies as payments to Government Agencies. However, the Government failed to report these payments in their reporting templates. The differences are detailed by company and by tax are shown below:

Companies	Total	Withholding tax	Signature Bonus	Income Tax (IT)	Other Taxes
TOTAL	4,628,617,438	4,546,021,485	-	-	82,595,953
Unocal Myanmar Offshore Co., Ltd	366,878,352	-	-	366,878,352	-
SNOG Pte Ltd	746,445,122	-	746,445,122	-	-
Geopetrol International Holding Inc	250,064,092	250,064,092	-	-	-
Goldpetrol Co Ltd	99,111,988	-	-	-	99,111,988
Petronas Carigali Hong Kong Ltd (PCML)	54,612,470	-	-	54,612,470	-
	6,145,729,462	4,796,085,578	746,445,122	421,490,822	181,707,941

The difference related to the withholding tax is explained by the fact that this withholding is paid by TOTAL as tax agent on behalf of its suppliers and sub-contractors. IRD did not maintain in its record the identity of the company that paid this withholding tax and cannot therefore confirm that this amount was paid by TOTAL. The payment receipt (challan) mention only the name of the supplier or sub-contractor and do not include the name of the company that withheld and paid the tax to IRD.

(e) Not material difference

These differences correspond to immaterial differences i.e. differences falling below materiality threshold of **MMK 5,000,000** as described in Section 2.3 above.

5.1.4. In kind reconciliation

The table below summarises the differences, by tax, relating to in kind payments reported by extractive companies and receipts reported by Government Agencies:

N°	Description of payment	Per company			Per Government			Final difference
		initial	Adjust	Final	initial	Adjust	Final	
Payments in kind								
	In Barils	1,259,501	-	1,259,501	1,259,501	-	1,259,501	-
1.1	State production entitlement	-	-	-	-	-	-	-
2.1	MOGE production entitlement	215,256	-	215,256	215,256	-	215,256	-
3.1	Royalties	78,275	-	78,275	78,275	-	78,275	-
4.1	Baseline payment (IPR/PCC)	601,203	-	601,203	601,203	-	601,203	-
5.1	Risk compensation (IPR/PCC)	360,365	-	360,365	360,365	-	360,365	-
6.1	Payment out of production (-)	-	-	-	-	-	-	-
7.1	Domestic Market Obligation (DMO) (-)	4,403	-	4,403	4,403	-	4,403	-
	In MMscf	130,283	-	130,283	645	-	645	129,638
1.2	State production entitlement	126,497	-	126,497	-	-	-	126,497
2.2	MOGE production entitlement	34,502	-	34,502	-	-	-	34,502
3.2	Royalties	32,701	-	32,701	-	-	-	32,701
4.2	Baseline payment (IPR/PCC)	617	-	617	617	-	617	-
5.2	Risk compensation (IPR/PCC)	28	-	28	28	-	28	-
6.2	Payment out of production (-)	-	-	-	-	-	-	-
7.2	Domestic Market Obligation (DMO) (-)	(64,062)	-	(64,062)	-	-	-	(64,062)

5.1.5. Unreconciled discrepancies

Following our reconciliation work, the total unreconciled in kind discrepancies is 129,638 MMSCF, representing 20% of total in kind payments reported by Government Agencies. These unreconciled differences were declared by companies but not by Government Agencies and are summarised as follows:

Company	in MSCF
PTTEP International Ltd.	27,548
TOTAL	102,090
Total discrepancies	129,638

5.2. Payments of Gems and Jade companies

5.2.1. Cash flows reconciliation by company

The tables below summarise the differences between payments reported by extractive companies and receipts reported by Government Agencies.

The tables include consolidated figures based on the reporting templates prepared by each extractive company and Government Agency, adjustments made following our reconciliation work and the residual, unreconciled differences:

Amounts in MMK

No.	Company	Templates originally lodged			Adjustments			Final amounts		
		Extractive company (a)	Government (b)	Difference (c) =(a - b)	Extractive company (d)	Government (e)	Difference (f) = (d-e)	Extractive company (g) = (a+d)	Government (h) = (b+e)	Difference (i) = (g-h)
1	Myanmar Win Gate Gems & Jewellery Mining	29,380,792,750	33,757,318,707	(4,376,525,957)	-	(4,368,922,883)	4,368,922,883	29,380,792,750	29,388,395,824	(7,603,074)
2	Sein Lom Taung Tan Gems Ltd.	15,393,769,616	17,575,218,149	(2,181,448,533)	-	(2,141,419,769)	2,141,419,769	15,393,769,616	15,433,798,380	(40,028,764)
3	Yar Za Htar Ne Gems Co.;Ltd.	11,186,159,260	16,498,722,856	(5,312,563,596)	(33,212,798)	(52,751,185)	19,538,387	11,152,946,462	16,445,971,671	(5,293,025,209)
4	Myanmar Imperial Jade(Gems & Jewellery)	9,914,048,074	10,618,654,104	(704,606,030)	-	-	-	9,914,048,074	10,618,654,104	(704,606,030)
5	Wai Aung Gabar Gems Co; Ltd.	9,047,580,356	10,478,190,391	(1,430,610,035)	-	(1,109,533,541)	1,109,533,541	9,047,580,356	9,368,656,850	(321,076,494)
6	Ayar Jade Co; Ltd.	7,780,850,002	8,906,172,816	(1,125,322,814)	-	-	-	7,780,850,002	8,906,172,816	(1,125,322,814)
7	Myat Yamon Gems Co.;Ltd.	7,504,411,655	8,585,266,361	(1,080,854,706)	-	(1,038,613,931)	1,038,613,931	7,504,411,655	7,546,652,430	(42,240,775)
8	Kyauk Seinn Nagar (Gems)	7,513,302,209	8,406,665,633	(893,363,424)	-	(1,096,442,411)	1,096,442,411	7,513,302,209	7,310,223,222	203,078,987
9	Myanmar Sithu Jewellery	6,738,073,952	7,804,515,978	(1,066,442,026)	397,607,387	(668,834,639)	1,066,442,026	7,135,681,339	7,135,681,339	-
10	Linn Lett Win Yadana Gems	5,782,059,010	7,963,720,939	(2,181,661,929)	799,161,440	(1,262,686,877)	2,061,848,317	6,581,220,450	6,701,034,062	(119,813,612)
11	Yadana Taung Tann Gems	4,282,133,407	5,270,185,142	(988,051,735)	257,731,714	(633,746,143)	891,477,857	4,539,865,121	4,636,438,999	(96,573,878)
12	Khin Zaw Aung & Brothers Gems & Jewellery	4,365,430,184	5,331,058,321	(965,628,137)	-	(700,946,735)	700,946,735	4,365,430,184	4,630,111,586	(264,681,402)
13	Shwe Gaung Gaung Gems	4,896,386,784	5,155,246,997	(258,860,213)	(832,359,602)	(1,169,476,677)	337,117,074	4,064,027,182	3,985,770,320	78,256,862

No.	Company	Templates originally lodged			Adjustments			Final amounts		
		Extractive company (a)	Government (b)	Difference (c) =(a - b)	Extractive company (d)	Government (e)	Difference (f) = (d-e)	Extractive company (g) = (a+d)	Government (h) = (b+e)	Difference (i) = (g-h)
14	Xie Family	3,538,739,007	3,538,739,007	-	-	-	-	3,538,739,007	3,538,739,007	-
15	Great Genesis Gems Co; Ltd.	3,212,932,359	3,614,105,065	(401,172,706)	-	(433,633,486)	433,633,486	3,212,932,359	3,180,471,579	32,460,780
16	Richest Gems Co;Ltd.	2,940,827,877	3,371,756,917	(430,929,040)	-	(450,707,420)	450,707,420	2,940,827,877	2,921,049,497	19,778,380
17	Kyaing International Gems	2,475,950,242	3,229,808,768	(753,858,526)	533,346,581	(336,487,995)	869,834,576	3,009,296,823	2,893,320,773	115,976,050
18	Phyo Thiha Kyaw Gems	2,770,534,895	3,099,345,159	(328,810,264)	(48,186,410)	(380,987,710)	332,801,300	2,722,348,485	2,718,357,449	3,991,036
20	Kyaw Naing & Brothers	1,215,623,601	2,687,116,836	(1,471,493,235)	178,183,754	(508,725,670)	686,909,424	1,393,807,355	2,178,391,166	(784,583,811)
21	Kyay Sin Phyu	-	-	-	-	-	-	-	-	-
22	HTOO JEWELLERY CO.,LTD.	1,403,857,591	1,948,441,251	(544,583,661)	-	(542,134,578)	542,134,578	1,403,857,591	1,406,306,673	(2,449,083)
23	Ngwe Hein Htet Gems & Jewellery	1,371,201,043	2,213,609,921	(842,408,878)	(4,344,461)	(850,116,906)	845,772,446	1,366,856,582	1,363,493,014	3,363,568
24	Lyan Shan Jewellery Co; Ltd.	2,157,340,824	1,714,218,049	443,122,775	(501,832,587)	(216,338,285)	(285,494,302)	1,655,508,237	1,497,879,764	157,628,473
25	Yadanar Pyi Phyo Aung Gems And Jewellery Co; Ltd.	1,627,561,768	2,403,618,902	(776,057,134)	11,687,378	(710,776,326)	722,463,704	1,639,249,146	1,692,842,576	(53,593,430)
26	PAING PHYO THIIHA GEMS	1,222,162,343	2,455,505,660	(1,233,343,317)	436,000,000	(784,874,090)	1,220,874,090	1,658,162,343	1,670,631,570	(12,469,227)
27	EIGHTY THOUSAND GEMS & JEWELLERY Co;Ltd	10,878,690,784	1,143,853,666	9,734,837,118	-	-	-	10,878,690,784	1,143,853,666	9,734,837,118
28	Tun Naing Aung Gems	2,000,109,180	2,049,132,641	(49,023,460)	-	-	-	2,000,109,180	2,049,132,641	(49,023,460)
29	Thit Sar Pan	2,706,634	198,974,970	(196,268,336)	-	(191,414,970)	191,414,970	2,706,634	7,560,000	(4,853,366)
30	Chaow Brothers Gemstone	1,904,329,723	2,087,861,340	(183,531,617)	-	(177,030,052)	177,030,052	1,904,329,723	1,910,831,288	(6,501,565)
31	Mann Ayer Family Co.,Ltd.	-	1,759,651,175	(1,759,651,175)	-	(688,131,744)	688,131,744	-	1,071,519,430	(1,071,519,430)
32	(1.1.1) Gems & Jewellery	1,247,804,456	1,905,701,422	(657,896,966)	94,672,003	(306,371,759)	401,043,762	1,342,476,459	1,599,329,663	(256,853,204)
33	Oo Ya Gems & Jewellery Co;Ltd.	1,055,851,406	1,241,421,112	(185,569,706)	(10,321,256)	(193,998,702)	183,677,446	1,045,530,150	1,047,422,410	(1,892,260)
35	Myanmar Economics Corporation	815,523,234	823,380,303	(7,857,069)	-	-	-	815,523,234	823,380,303	(7,857,069)
36	Pang Huke Duwa Co;	915,148,071	1,398,778,038	(483,629,967)	-	(142,208,351)	142,208,351	915,148,071	1,256,569,687	(341,421,616)

No.	Company	Templates originally lodged			Adjustments			Final amounts		
		Extractive company (a)	Government (b)	Difference (c) =(a - b)	Extractive company (d)	Government (e)	Difference (f) = (d-e)	Extractive company (g) = (a+d)	Government (h) = (b+e)	Difference (i) = (g-h)
	Ltd.									
37	Khun Pa-Oh Gems & Jewellery	2,785,178,383	3,171,202,036	(386,023,652)	-	(355,576,939)	355,576,939	2,785,178,383	2,815,625,097	(30,446,714)
38	Kachin National Development	1,047,597,080	1,536,569,823	(488,972,743)	-	(146,432,561)	146,432,561	1,047,597,080	1,390,137,262	(342,540,182)
39	Silver Elephant Gems	2,291,055,028	2,366,051,496	(74,996,468)	-	-	-	2,291,055,028	2,366,051,496	(74,996,468)
40	Myo Nwe Gems & Jewellery	2,578,265,596	2,701,400,984	(123,135,388)	-	-	-	2,578,265,596	2,701,400,984	(123,135,388)
41	Shining Star Light Gems & Jewellery	2,824,692,936	2,985,606,549	(160,913,613)	-	(744,100,952)	744,100,952	2,824,692,936	2,241,505,597	583,187,339
42	Myanma Seinn Lei Aung Gems	16,614,638	3,056,516,793	(3,039,902,155)	-	(261,674,250)	261,674,250	16,614,638	2,794,842,543	(2,778,227,905)
43	Myanmar Naing Group	1,653,568,928	1,646,801,122	6,767,807	-	-	-	1,653,568,928	1,646,801,122	6,767,807
44	Pho Thar Htoo Gems Co; Ltd.	1,740,783,483	1,884,516,365	(143,732,883)	26,440,443	(254,058,578)	280,499,021	1,767,223,926	1,630,457,788	136,766,138
45	RUBY DRAGON JADE & GEMS Co.,Ltd	1,962,927,030	3,100,820,963	(1,137,893,933)	-	(248,005,818)	248,005,818	1,962,927,030	2,852,815,144	(889,888,114)
46	Thi Raw Mani Gems & Jewellery	1,876,381,368	2,246,409,360	(370,027,992)	-	(231,946,041)	231,946,041	1,876,381,368	2,014,463,318	(138,081,951)
47	Kan Par Ni Gems & Jewellery Co.,Ltd.	536,000,000	622,330,239	(86,330,239)	86,330,239	-	86,330,239	622,330,239	622,330,239	-
48	Golden Grate Wall Gems Co., Ltd	333,743,980	534,366,895	(200,622,915)	-	(198,555,507)	198,555,507	333,743,980	335,811,388	(2,067,408)
49	Kyauk Gyi Gone Gems & Jewellery Co., Ltd	694,476,707	1,114,169,135	(419,692,428)	-	(326,913,287)	326,913,287	694,476,707	787,255,848	(92,779,141)
50	Phar Kant Yar Zar Gems & Jewellery Co.,Ltd	144,901,381	355,206,345	(210,304,964)	-	(101,425,134)	101,425,134	144,901,381	253,781,212	(108,879,830)
51	Zwe Htet Lwin Gems & Jewellery Co.,Ltd	461,401,399	782,458,510	(321,057,111)	24,743,835	(296,313,276)	321,057,111	486,145,234	486,145,234	-
52	Lin Yaung Phyar Gems Co.,Ltd	417,539,158	801,118,229	(383,579,071)	115,434,334	(268,144,737)	383,579,071	532,973,492	532,973,492	-
53	Kaung Wai Yan Gems Co.,Ltd	43,654,775	51,204,929	(7,550,154)	-	(17,977,774)	17,977,774	43,654,775	33,227,154	10,427,620
54	Yadanar San Shwin Gems Co., Ltd	842,147,083	1,156,062,998	(313,915,915)	92,450,000	(213,847,324)	306,297,324	934,597,083	942,215,674	(7,618,591)

No.	Company	Templates originally lodged			Adjustments			Final amounts		
		Extractive company (a)	Government (b)	Difference (c) =(a - b)	Extractive company (d)	Government (e)	Difference (f) = (d-e)	Extractive company (g) = (a+d)	Government (h) = (b+e)	Difference (i) = (g-h)
55	SHWE BYAIN PHYU CO	87,950,224	2,342,207,696	(2,254,257,472)	-	-	-	87,950,224	2,342,207,696	(2,254,257,472)
56	NILAR YOMA TRADING	42,571,951	3,947,983,617	(3,905,411,666)	-	(3,904,922,568)	3,904,922,568	42,571,951	43,061,049	(489,098)
57	Jade Mountain Gems Co.,Ltd.	2,765,747,173	2,922,913,979	(157,166,806)	-	(204,960,483)	204,960,483	2,765,747,173	2,717,953,496	47,793,677
58	Ever Winner Gems	1,457,694,649	2,307,355,795	(849,661,145)	174,326,084	(675,335,061)	849,661,145	1,632,020,733	1,632,020,733	-
59	Kaung Myat Thu Kha Co. Ltd	1,054,934,326	909,874,868	145,059,458	-	-	-	1,054,934,326	909,874,868	145,059,458
60	Jade Padathar Gems + Shwe Gaung Gaung Gems	1,109,601,159	1,635,455,052	(525,853,893)	-	(498,746,854)	498,746,854	1,109,601,159	1,136,708,198	(27,107,040)
61	Khine Myanmar Gems Co.,Ltd.	2,572,702,278	2,910,399,142	(337,696,865)	179,383,165	(156,271,833)	335,654,998	2,752,085,443	2,754,127,310	(2,041,867)
62	Kan Pwint Oo	187,846,252	1,165,838,450	(977,992,198)	-	(82,416,189)	82,416,189	187,846,252	1,083,422,261	(895,576,009)
63	KHA YANN MYAY GEMS	795,091,311	1,305,900,410	(510,809,099)	-	(510,609,099)	510,609,099	795,091,311	795,291,311	(200,000)
64	Kyay Lin	98,689,411	98,428,855	260,556	-	-	-	98,689,411	98,428,855	260,556
65	Kyaw Thet Aung	-	550,000,000	(550,000,000)	550,000,000	-	550,000,000	550,000,000	550,000,000	-
67	Aung Hein Min Gems Co.,Ltd	667,468,317	1,165,165,027	(497,696,711)	281,656,023	(216,040,688)	497,696,711	949,124,340	949,124,340	-
68	YadanarYaungChi Gems Co.,Ltd	499,006,079	725,467,026	(226,460,947)	-	(115,167,359)	115,167,359	499,006,079	610,299,667	(111,293,588)
69	Yadanar Kaung Kin Gems & Jewellery Co.,Ltd	8,310,562,152	7,703,415,867	607,146,285	-	-	-	8,310,562,152	7,703,415,867	607,146,285
70	Big Jade Gems Co.,Ltd.	175,862,598	235,786,003	(59,923,405)	-	(92,206,958)	92,206,958	175,862,598	143,579,046	32,283,553
71	Golden Wallet Jewellery Co.,Ltd	239,152,779	408,788,490	(169,635,711)	-	(150,625,275)	150,625,275	239,152,779	258,163,215	(19,010,436)
72	Tun Tauk Sa Gems Co.,Ltd.	428,164,564	761,152,471	(332,987,907)	-	(297,164,921)	297,164,921	428,164,564	463,987,550	(35,822,986)
Total		209,285,866,469	250,444,902,110	(41,159,035,641)	2,808,897,267	(31,726,752,297)	34,535,649,564	212,094,763,736	218,718,149,813	(6,623,386,077)

5.2.2. Cash flows reconciliation by revenue stream

The table below shows the original payments reported by extractive companies and Government Agencies, taking into account all adjustments:

Amounts in MMK

N°	Description of Payment	Templates originally lodged			Adjustments			Final amounts		
		Extractive company	Govt	Difference	Extractive company	Govt	Difference	Extractive company	Govt	Difference
Payments in Cash										
Ministry of Natural Resources and Environmental Conservation (MONREC)										
Myanmar Gems Enterprise (MGE)										
Dept of Mines (DOM)										
Forest Department										
1	Royalties on production - 20% collected by/paid to MGE	2,960,041,062	2,872,346,051	87,695,011	(534,027,982)	9,908,764	(543,936,746)	2,426,013,080	2,882,254,815	(456,241,735)
2	Royalties on production- 20% collected by/paid to DOM	9,821,334,478	-	9,821,334,478	(128,464,260)	-	(128,464,260)	9,692,870,218	-	9,692,870,218
3	Sale Split - 40%	112,777,128,588	115,215,852,064	(2,438,723,476)	1,169,196,785	13,929,940	1,155,266,844	113,946,325,373	115,229,782,004	(1,283,456,631)
4	Royalties on Sales- 7%	38,549,337,786	40,855,071,290	(2,305,733,504)	728,359,376	(511,309,003)	1,239,668,379	39,277,697,162	40,343,762,287	(1,066,065,125)
5	Service Fees - 3%, 1%	18,724,870,137	17,509,313,873	1,215,556,264	(1,276,870,851)	(103,246,289)	(1,173,624,562)	17,447,999,287	17,406,067,585	41,931,702
6	Permit fees	5,033,543,216	9,829,434,000	(4,795,890,784)	2,314,871,186	-	2,314,871,186	7,348,414,402	9,829,434,000	(2,481,019,598)
7	Incentive fees 1%, 2%	2,924,919,608	2,734,526,526	190,393,081	(110,176,725)	-	(110,176,725)	2,814,742,882	2,734,526,526	80,216,356
8	Commercial Tax - 15%, 5% collected by (paid to) MGE	100,432,388	-	100,432,388	(100,432,388)	-	(100,432,388)	-	-	-
9	Land rental fees	760,485,634	-	760,485,634	(760,000,000)	-	(760,000,000)	485,634	-	485,634
10	Environmental / Plantation fees	-	-	-	-	-	-	-	-	-
11	Other significant payments (> 50,000 USD) MGE	1,117,103,172	1,648,920,937	(531,817,764)	(459,271,777)	-	(459,271,777)	657,831,395	1,648,920,937	(991,089,541)
Ministry of Planning and Finance (IRD)										
Customs department										
12	Income Tax (IT)	2,070,024,457	5,147,151,574	(3,077,127,117)	134,856,839	(2,385,633,988)	2,520,490,827	2,204,881,296	2,761,517,586	(556,636,290)
13	Commercial Tax	8,791,922,237	22,426,838,471	(13,634,916,234)	417,580,652	(11,981,847,295)	12,399,427,947	9,209,502,889	10,444,991,176	(1,235,488,287)
14	Custom Duties	1,773,169,108	3,162,950,495	(1,389,781,387)	132,342,720	(71,068,523)	203,411,243	1,905,511,828	3,091,881,972	(1,186,370,144)
15	Royalties on Sales	710,903,552	21,354,083,479	(20,643,179,926)	(520,526,481)	(16,423,600,192)	15,903,073,712	190,377,071	4,930,483,286	(4,740,106,215)
16	Other significant payments (> 50,000 USD) IRD	16,559,206	-	16,559,206	-	-	-	16,559,206	-	16,559,206
Central Committee (MONREC)										
3,154,091,840 7,688,413,350 (4,534,321,510) 1,801,460,173 (273,885,711) 2,075,345,884 4,955,552,013 7,414,527,639 (2,458,975,626)										

N°	Description of Payment	Templates originally lodged			Adjustments			Final amounts		
		Extractive company	Govt	Difference	Extractive company	Govt	Difference	Extractive company	Govt	Difference
17	Emporium Fees / Sale Fees	3,154,091,840	7,688,413,350	(4,534,321,510)	1,801,460,173	(273,885,711)	2,075,345,884	4,955,552,013	7,414,527,639	(2,458,975,626)
States/Regions		-	-	-	-	-	-	-	-	-
18	Contribution to the State/region social development fund	-	-	-	-	-	-	-	-	-
Total payments		209,285,866,469	250,444,902,110	(41,159,035,641)	2,808,897,267	(31,726,752,297)	34,535,649,564	212,094,763,736	218,718,149,813	(6,623,386,077)

5.2.3. In kind flows reconciliation

The tables below summarise the differences, in-kind production reported by extractive companies and receipts reported by MGE by company:

N°	Description of Payment	Templates originally lodged			Adjustments			Final amounts		
		Extractive company	Govt	Difference	Extractive company	Govt	Difference	Extractive company	Govt	Difference
Jade in Kg										
Payments in Kind										
Production Split (Government and SOEs share)		569,920	31,728	538,192	-	-	-	569,920	31,728	538,192
1	Wai Aung Gabar Gems Co; Ltd.	420,922	-	420,922	-	-	-	420,922	-	420,922
2	Kyauk Seinn Nagar (Gems)	-	22,889	(22,889)	-	-	-	-	22,889	(22,889)
3	Khin Zaw Aung & Brothers Gems & Jewellery	148,608	1,884	146,724	-	-	-	148,608	1,884	146,724
4	Shwe Gaung Gaung Gems	-	6,955	(6,955)	-	-	-	-	6,955	(6,955)
5	Kachin National Development	390	-	390	-	-	-	390	-	390
Total payments		569,920	31,728	538,192	-	-	-	569,920	31,728	538,192

5.2.4. Unreconciled discrepancies

Following our adjustments (See Appendix 4), the total unreconciled discrepancies amounted to MMK (6,623,386,077) representing (3.03%) of total payments reported by Government Agencies. This is the sum of positive differences of MMK 9,832,063,115 and negative differences amounting to MMK (16,455,449,192). These unreconciled differences can be analysed as follows:

Reasons for differences	Unreconciled difference
Tax not reported by the extractive company	(20,285,375,148)
Tax not reported by the Govt Body	13,664,043,763
Not material difference < 5 Million Kyats	(2,054,692)
Total Differences	(6,623,386,077)

(a) Tax not reported by the extractive company

This difference relates to taxes declared by Government Agencies as payments from gems and jade companies. However, the companies failed to report these payments in their reporting templates. The differences are detailed by company and by tax as below:

Company	Total	Royalties on Sales (to IRD)	Custom Duties	Sale Split - 40%	Permit fees	Emporium Fees / Sale Fees	Commercial Tax	Royalties on Sales- 7% (to MGE)	Other Taxes
Yar Za Htar Ne Gems Co.,Ltd.	(5,619,153,097)	(4,843,587,772)	(151,683,239)	-	-	(260,449,984)	-	-	(363,432,102)
Myanma Seinn Lei Aung Gems	(2,778,227,905)	-	-	(1,271,593,731)	(1,056,661,107)	(36,873,064)	-	(255,620,767)	(157,479,237)
SHWE BYAIN PHYU CO	(2,254,257,472)	-	(1,760,298,064)	(267,781,641)	-	(21,883,934)	-	(103,565,585)	(100,728,248)
Ayar Jade Co; Ltd.	(1,131,961,140)	-	-	-	-	-	(1,111,279,260)	-	(20,681,880)
Mann Ayer Family Co.,Ltd.	(1,071,519,430)	-	-	-	-	(88,474,081)	-	(688,131,744)	(294,913,605)
RUBY DRAGON JADE & GEMS Co.,Ltd	(934,400,000)	-	-	-	(934,400,000)	-	-	-	-
Kan Pwint Oo	(896,140,879)	-	-	(148,452,068)	-	(53,072,805)	(497,154,644)	-	(197,461,362)
Myanmar Imperial Jade	(808,087,587)	-	-	-	-	(596,449,817)	-	-	(211,637,770)
Kyaw Naing & Brothers	(791,779,402)	-	-	-	-	-	(565,556,716)	-	(226,222,686)
Kachin National Development	(345,546,019)	-	-	(10,746,019)	(334,800,000)	-	-	-	-
Pang Huke Duwa Co; Ltd.	(342,449,638)	-	-	(95,316,547)	-	(52,329,965)	-	-	(194,803,126)
Wai Aung Gabar Gems Co; Ltd.	(321,076,494)	-	-	-	-	(6,396,157)	-	-	(314,680,337)
YadanarYaungChi Gems Co.,Ltd	(309,489,522)	-	-	-	-	(210,181,042)	-	-	(99,308,480)
(1.1.1) Gems & Jewellery	(299,183,199)	-	-	-	-	(252,835,313)	-	(32,443,142)	(13,904,744)
Shining Star Light Gems & Jewellery	(278,602,590)	-	-	(145,676,392)	(8,000,000)	(17,946,245)	-	-	(106,979,953)
Khin Zaw Aung & Brothers	(260,723,402)	-	-	(242,011,196)	-	(18,712,206)	-	-	-
Myat Yamon Gems Co;Ltd.	(245,079,017)	-	-	-	-	(182,701,054)	-	-	(62,377,963)
Myo Nwe Gems & Jewellery	(226,517,590)	-	-	-	(141,124,000)	(85,393,590)	-	-	-
Thi Raw Mani Gems & Jewellery	(214,235,036)	-	-	-	-	(44,650,579)	-	-	(169,584,456)
Other companies	(1,156,945,730)	-	(50,156,877)	-	(42,280,000)	(572,836,784)	(7,603,074)	(78,981,262)	(405,087,733)
Total	(20,285,375,148)	(4,843,587,772)	(1,962,138,180)	(2,181,577,593)	(2,517,265,107)	(2,501,186,620)	(2,181,593,694)	(1,158,742,501)	(2,939,283,681)

(b) Tax not reported by Government Agency

This difference relates to taxes declared by gems and jade companies as payments to Government Agencies. However, the Government Agencies did not report these payments in their reporting templates. The differences are detailed by company by tax below:

Company	Total	Royalties on production- 20% collected by/paid to DOM	Commercial Tax	Custom Duties	Sale Split - 40%	Service Fees - 3%, 1%	Other Taxes
EIGHTY THOUSAND GEMS & JEWELLERY Co;Ltd	9,860,704,050	9,692,870,218	-	-	-	20,977,705	146,856,127
Shining Star Light Gems & Jewellery	856,613,287	-	678,841,883	100,323,008	-	-	77,448,396
Yadanar Kaung Kin Gems & Jewellery Co;Ltd	606,654,951	-	-	606,654,951	-	-	-
Yar Za Htar Ne Gems Co;Ltd.	326,859,239	-	-	-	49,737,458	267,253,532	9,868,248
Kyauk Seinn Nagar (Gems)	215,130,276	-	-	-	153,874,494	61,255,782	-
Myat Yamon Gems Co;Ltd.	201,880,771	-	-	18,704,862	93,667,830	28,059,519	61,448,560
Yadanar Yaung Chi Gems Co;Ltd	201,654,226	-	125,517,274	-	-	5,841,832	70,295,121
Kyaing International Gems	190,965,060	-	-	-	145,485,489	45,479,571	-
Lyan Shan Jewellery Co; Ltd.	166,425,772	-	-	-	147,391,001	19,034,771	-
Kaung Myat Thu Kha Co. Ltd	145,059,458	-	68,203,099	16,250,526	-	-	60,605,833
Pho Thar Htoo Gems Co; Ltd.	138,810,111	-	71,600,555	39,338,096	-	-	27,871,460
Other companies	753,286,561	-	-	-	308,761,850	116,489,758	328,034,953
Total	13,664,043,763	9,692,870,218	944,162,811	781,271,443	898,918,123	564,392,470	782,428,698

(c) Not material difference

These differences correspond to immaterial differences above i.e. falling below the materiality threshold of **MMK 5,000,000** as described in the Section 2.3 above.

5.3. Payments of other minerals companies

5.3.1. Cash flows reconciliation by company

The tables below shows the differences between the payments reported by extractive companies and receipts reported by Government Agencies.

The tables include consolidated figures based on the reporting templates prepared by each extractive company and Government Agencies, adjustments made following our reconciliation work and the residual unreconciled differences:

Amounts in MMK

No.	Company	Templates originally lodged			Adjustments			Final amounts		
		Extractive company (a)	Government (b)	Difference (c) = (a - b)	Extractive company (d)	Government (b)	Difference (f) = (d-e)	Extractive company (g) = (a+d)	Government (h) = (b+e)	Difference (i) = (g-h)
1	Myanmar CNMC Nickel Co; LTD	40,517,292,405	49,073,776,063	(8,556,483,657)	1,900,654,473	-	1,900,654,473	42,417,946,879	49,073,776,063	(6,655,829,184)
2	Myanma Economic Corporation	1,260,220	17,828,158,685	(17,826,898,465)	-	(17,822,576,328)	17,822,576,328	1,260,220	5,582,357	(4,322,137)
3	Ruby Dragon Mining Co., Ltd.	729,897,506	123,675,307	606,222,199	-	45,026,614	(45,026,614)	729,897,506	168,701,921	561,195,585
4	Shwe Taung Mining Co., Ltd.	163,712,120	907,030,764	(743,318,644)	462,076,959	-	462,076,959	625,789,079	907,030,764	(281,241,685)
5	NgweYi Palae Mining Co.,Ltd	988,506,580	1,234,693,217	(246,186,637)	-	-	-	988,506,580	1,234,693,217	(246,186,637)
6	Win Myint Mo Industries Co.,Ltd	1,674,603,665	2,132,456,070	(457,852,404)	-	-	-	1,674,603,665	2,132,456,070	(457,852,404)
7	Tha Byu Mining Co.,Ltd	406,620,611	363,174,567	43,446,044	(48,077,700)	-	(48,077,700)	358,542,911	363,174,567	(4,631,656)
8	GPS Joint Venture Co., Ltd.	438,140,595	438,140,595	-	-	-	-	438,140,595	438,140,595	-
9	Electrum Mining Co; Ltd	116,220,000	257,492,893	(141,272,893)	-	-	-	116,220,000	257,492,893	(141,272,893)
10	Max Myanmar Industry Co.,Ltd	789,106,723	336,205,612	452,901,111	-	-	-	789,106,723	336,205,612	452,901,111
11	Htoo International Industrial Gorup Co.,Ltd	53,000,000	108,310,700	(55,310,700)	-	-	-	53,000,000	108,310,700	(55,310,700)
12	Tun Thwin Mining Co., Ltd	273,505,200	258,683,700	14,821,500	-	-	-	273,505,200	258,683,700	14,821,500
13	Shwe Moe Yan Co.,Ltd	1,160,447,157	6,704,908	1,153,742,249	-	-	-	1,160,447,157	6,704,908	1,153,742,249
14	Myanmar Yang Tse Copper Ltd	2,718,666,657	8,642,026,482	(5,923,359,826)	-	-	-	2,718,666,657	8,642,026,482	(5,923,359,826)
15	Sea Sun Star Mining Production & Marketing Co.,Ltd	353,193,730	35,573,322	317,620,408	-	-	-	353,193,730	35,573,322	317,620,408
16	Eastern Mining Co.,Ltd	4,415,253	24,463,142	(20,047,889)	-	-	-	4,415,253	24,463,142	(20,047,889)

No.	Company	Templates originally lodged			Adjustments			Final amounts		
		Extractive company (a)	Government (b)	Difference (c) =(a - b)	Extractive company (d)	Government (b)	Difference (f) = (d-e)	Extractive company (g) = (a+d)	Government (h) = (b+e)	Difference (i) = (g-h)
17	Swan Yadanar Htay Mining Co;Ltd	7,500,000	18,945,384	(11,445,384)	-	-	-	7,500,000	18,945,384	(11,445,384)
18	Swan Min Htet Mining Co;Ltd	7,500,000	19,338,276	(11,838,276)	-	-	-	7,500,000	19,338,276	(11,838,276)
19	Aung Brother Mining Co;Ltd	1,307,624	43,297,857	(41,990,233)	-	-	-	1,307,624	43,297,857	(41,990,233)
20	Eternal Mining Co., Ltd	1,126,811,451	1,237,198,501	(110,387,050)	-	-	-	1,126,811,451	1,237,198,501	(110,387,050)
21	National Prosperity Gold Production Group Ltd.	1,625,045,254	106,870,339	1,518,174,915	(1,519,916,100)	-	(1,519,916,100)	105,129,154	106,870,339	(1,741,185)
22	Geo Asia Industrial and Mining Co., Ltd.	19,820,153	6,611,987	13,208,166	-	-	-	19,820,153	6,611,987	13,208,166
23	Myanmar Golden Point Family Co., Ltd.	93,444,044	93,444,044	-	-	-	-	93,444,044	93,444,044	-
24	THAN TAW MYAT CO,LTD	5,056,200	68,610,409	(63,554,209)	-	-	-	5,056,200	68,610,409	(63,554,209)
25	BAGAN BUSINESS GROUP	-	71,713,477	(71,713,477)	-	-	-	-	71,713,477	(71,713,477)
26	Delco Co.,Ltd	324,139,542	50,700,000	273,439,542	-	-	-	324,139,542	50,700,000	273,439,542
27	Myanmar Pongpipat Co.,L td	229,004,966	255,043,510	(26,038,544)	48,058,500	20,876,606	27,181,894	277,063,466	275,920,116	1,143,350
28	Kayar Mine Production Co., Ltd	70,367,195	86,675,295	(16,308,100)	-	-	-	70,367,195	86,675,295	(16,308,100)
29	Ye Htut Kyaw Mining Co.,Ltd	69,461,706	83,889,488	(14,427,782)	-	-	-	69,461,706	83,889,488	(14,427,782)
Total		53,968,046,557	83,912,904,593	(29,944,858,036)	842,796,132	(17,756,673,108)	18,599,469,240	54,810,842,689	66,156,231,485	(11,345,388,796)

5.3.2. Cash flows reconciliation by revenue stream

The table below shows the total Payments reported by extractive companies and Government Agencies, taking into account all adjustments:

Amounts in MMK

N° Description	Templates originally lodged			Adjustments			Final amounts		
	Extractive company (a)	Government (b)	Difference (c) = (a - b)	Extractive company (d)	Government (e)	Difference (f) = (d-e)	Extractive company (g) = (a+d)	Government (h) = (b+e)	Difference (i) = (g-h)
Payments in cash									
MoF-IRD-Customs Department	53,968,046,557	83,912,904,593	(29,944,858,036)	842,796,132	(17,756,673,108)	18,599,469,240	54,810,842,689	66,156,231,485	(11,345,388,796)
1 Income Tax (IT)	7,313,637,325	30,375,692,843	(23,062,055,518)	(1,781,738,365)	(17,778,000,896)	15,996,262,531	5,531,898,960	12,597,691,947	(7,065,792,987)
2 Commercial Tax	2,477,862,462	22,786,990,717	(20,309,128,255)	(27,337,422)	(12,546,898,161)	12,519,560,739	2,450,525,040	10,240,092,556	(7,789,567,516)
3 Commercial Tax on Imports	1,332,295,208	6,753,818,521	(5,421,523,313)	(14,725,759)	(5,254,801,561)	5,240,075,802	1,317,569,449	1,499,016,960	(181,447,511)
4 Customs Duties	885,204,671	125,240,631	759,964,040	-	23,698,826	(23,698,826)	885,204,671	148,939,457	736,265,214
5 Stamp Duties	368,616,722	706,921,389	(338,304,667)	-	-	-	368,616,722	706,921,389	(338,304,667)
6 Capital Gains Tax	1,885,300	-	1,885,300	-	-	-	1,885,300	-	1,885,300
7 Withholding Tax	-	-	-	-	-	-	-	-	-
8 Other significant payments (> 50,000 USD)	528,615,618	2,721,585	525,894,033	(20,517,840)	-	(20,517,840)	508,097,778	2,721,585	505,376,193
MoM (ME 1-ME 2-ME 3)	1,719,157,344	-	1,719,157,344	(1,719,157,344)	-	(1,719,157,344)	-	-	-
9 Royalties	46,469,240,932	53,537,211,750	(7,067,970,818)	2,624,534,498	21,327,788	2,603,206,710	49,093,775,430	53,558,539,538	(4,464,764,109)
10 Signature Bonus	17,831,431,964	23,872,068,602	(6,040,636,638)	22,588,200	-	22,588,200	17,854,020,164	23,872,068,602	(6,018,048,438)
11 Production Split	301,000,000	163,602,500	137,397,500	48,058,500	-	48,058,500	349,058,500	163,602,500	185,456,000
12 Dead Rent Fees	25,172,610,291	27,285,499,658	(2,112,889,367)	2,633,747,098	-	2,633,747,098	27,806,357,388	27,285,499,658	520,857,730
13 Licence Fees	1,108,674,407	1,370,645,597	(261,971,190)	(90,524,300)	21,327,788	(111,852,088)	1,018,150,107	1,391,973,385	(373,823,278)
14 Dividends	1,058,445,500	82,000	1,058,363,500	-	-	-	1,058,445,500	82,000	1,058,363,500
15 Land rental fees	51,000,000	-	51,000,000	-	-	-	51,000,000	-	51,000,000
16 Environmental / Plantation fees	46,474,700	94,014,210	(47,539,510)	10,665,000	-	10,665,000	57,139,700	94,014,210	(36,874,510)
17 Other significant payments (> 50,000 USD)	144,185,100	-	144,185,100	-	-	-	144,185,100	-	144,185,100
States/regions	755,418,970	751,299,182	4,119,787	-	-	-	755,418,970	751,299,182	4,119,787
18 Contribution to the State/region social development fund	185,168,300	-	185,168,300	-	-	-	185,168,300	-	185,168,300
Total	53,968,046,557	83,912,904,593	(29,944,858,036)	842,796,132	(17,756,673,108)	18,599,469,240	54,810,842,689	66,156,231,485	(11,345,388,796)

5.3.3. Unreconciled discrepancies

Following the adjustments made (see Appendix 5), the total unreconciled discrepancies amounted to MMK 11,345,388,796 representing (17.15%) of total payments reported by Government Agencies. This is the sum of positive differences of MMK 3,392,677,125 and negative differences amounting to MMK (14,738,065,920). These unreconciled differences are summarised in the table below:

Reasons for differences	Unreconciled difference
Tax not reported by the extractive company	(16,725,911,173)
Tax not reported by the Govt Body	5,230,965,431
Missing extractive company detail per receipt number	204,451,521
Not material difference < 5 Million MMK	(54,894,575)
Total Differences	(11,345,388,796)

(a) Tax not reported by the extractive company

This difference is related to taxes declared by Government Agencies as a payment from gems and jade companies. However, the companies didn't report these payments in their reporting templates. The differences are detailed by company by tax as below:

		<i>Amounts in MMK</i>						
Company	Total	Income Tax (IT)	Royalties	Commercial Tax	Production Split	Customs Duties	Dead Rent Fees	Other Taxes
Myanmar CNMC Nickel Co; LTD	(7,776,396,247)	(7,653,645,625)	-	-	-	(17,646,006)	(105,104,616)	-
Myanmar Yang Tse Copper Ltd	(6,632,934,016)	-	(6,632,934,016)	-	-	-	-	-
NgweYi Palae Mining Co.,Ltd	(822,562,071)	(216,718,413)	-	(602,799,658)	-	-	-	(3,044,000)
Win Myint Mo Industries Co.,Ltd	(524,910,679)	-	(36,581,932)	-	(478,328,747)	-	-	(10,000,000)
Shwe Taung Mining Co., Ltd.	(280,239,685)	-	-	-	-	(280,239,685)	-	-
Electrum Mining Co; Ltd	(257,492,893)	-	-	-	-	-	(257,492,893)	-
Other companies	(431,375,581)	-	-	(11,449,983)	(11,145,300)	(274,749,802)	(59,265,936)	(74,764,560)
Total	(16,725,911,173)	(7,870,364,038)	(6,669,515,948)	(614,249,641)	(489,474,047)	(572,635,493)	(421,863,445)	(87,808,560)

(b) Taxes not reported by Government Agency

This difference related to taxes declared by gems and jade companies as a payments to Government Agencies. However, these institutions failed to report these payments in their reporting templates. The differences are detailed by company and by tax as shown in the table below:

Amounts in MMK

Company	Total	Licence Fees	Production Split	Royalties	Commercial Tax on Imports	Withholding Tax	Commercial Tax	Customs Duties	Signature Bonus	Other Taxes
Shwe Moe Yan Co.,Ltd	1,156,000,000	1,000,000,000	-	-	-	-	-	-	150,000,000	6,000,000
Myanmar CNMC Nickel Co; LTD	915,880,242	-	-	541,457,696	-	374,422,546	-	-	-	-
Myanmar Yang Tse Copper Ltd	709,574,191	-	-	-	484,876,715	-	-	224,697,476	-	-
NgweYi Palae Mining Co.,Ltd	576,487,188	-	483,191,700	44,755,500	-	-	-	-	-	48,539,988
Ruby Dragon Mining Co., Ltd.	570,193,085	57,743,500	449,955,733	62,493,852	-	-	-	-	-	-
Max Myanmar Industry Co.,Ltd	464,772,611	-	-	6,231,600	-	-	425,446,911	-	-	33,094,100
Sea Sun Star Mining Production & Marketing Co.,Ltd	328,210,560	-	81,816,000	-	-	81,816,000	7,078,560	-	36,500,000	121,000,000
Delco Co.,Ltd	298,339,542	-	-	-	34,678,361	45,711,659	-	15,632,092	50,000,000	152,317,430
Other companies	211,508,012	-	-	-	12,258,617	-	9,000,000	-	-	190,249,395
Total	5,230,965,431	1,057,743,500	1,014,963,433	654,938,647	531,813,693	501,950,205	441,525,471	240,329,568	236,500,000	551,200,913

(c) Missing extractive company detail per receipt number

(d) This difference corresponds to Commercial Tax on Imports reported by “Myanmar CNMC Nickel Co” without payments receipt numbers

(e) Not-material difference

These differences correspond to immaterial differences i.e. below the materiality threshold of **MMK 5 million** set for the reconciliation work as described in Section 2.3 above.

5.3.4. In Kind payment flows reconciliation

Following adjustments of in kind payments, final differences correspond to 1,035 ToZ of Gold and 33 MT of Tin between production split reported by mining companies and ME (2).

The table below summarises the differences, by tax, between in kind payments reported by extractive companies and receipts reported by Government Agencies:

N°	Description	Templates originally lodged			Adjustments			Final amounts		
		Extractive company (a)	Government (b)	Difference (c) =(a - b)	Extractive company (d)	Government (e)	Difference (f) = (d-e)	Extractive company (g) = (a+d)	Government (h) = (b+e)	Difference (i) = (g-h)
Payments in kind										
	Gold in oz-T	14,169	13,134	1,035	0	0	0	14,169	13,134	1,035
1	Production Split (Government and SOEs share)	9,569	13,134	(3,565)	0	0	0	9,569	13,134	(3,565)
2	Royalties	4,600	0	4,600	0	0	0	4,600	0	4,600
	Tin in MT	438	471	(33)	0	0	0	438	471	(33)
1	Production Split (Government and SOEs share)	409	471	(62)	0	0	0	409	471	(62)
2	Royalties	29	0	29	0	0	0	29	0	29
	Copper in MT	1,444	1,444	0	0	0	0	1,444	1,444	0
1	Production Split (Government and SOEs share)	0	0	0	0	0	0	0	0	0
2	Royalties	1,444	1,444	0	0	0	0	1,444	1,444	0

The table below summarises the differences, by company, between the payments in kind reported by extractive companies and receipts reported by Government Agencies:

N°	Description	Templates originally lodged			Adjustments			Final amounts		
		Extractive company (a)	Government (b)	Difference (c) =(a - b)	Extractive company (d)	Government (e)	Difference (f) = (d-e)	Extractive company (g) = (a+d)	Government (h) = (b+e)	Difference (i) = (g-h)
Payments in kind										
Gold in oz-T										
		14,169	13,134	1,035	-	-	-	14,169	13,134	1,035
1	Shwe Moe Yan Co.,Ltd	851	851	0	0	0	0	851	851	0
2	Swan Yadana Htay Mining Co;Ltd	63	63	0	0	0	0	63	63	0
3	Swan Min Htet Mining Co;Ltd	63	63	0	0	0	0	63	63	0
4	Eternal Mining Co., Ltd (*)	6,215	5,054	1,161	0	0	0	6,215	5,054	1,161
5	National Prosperity Gold Production Group Ltd.	4,600	4,613	-13	0	0	0	4,600	4,613	-13
6	Geo Asia Industrial and Mining Co., Ltd.	2,146	2,146	0	0	0	0	2,146	2,146	0
7	Myanmar Golden Point Family Co., Ltd.	231	231	0	0	0	0	231	231	0
8	Sea Sun Star Mining Production & Marketing Co.,Ltd	0	113	-113	0	0	0	0	113	-113
Tin in MT										
		438	471	-33	0	0	0	438	471	-32
1	Eastern Mining Co.,Ltd	15	15	0	0	0	0	15	15	0
2	Delco Co.,Ltd (*)	113	135	-22	0	0	0	113	135	-22
3	Myanmar Pongpipat Co.,L td (*)	126	129	-3	0	0	0	126	129	-3
4	Kayar Mine Production Co., Ltd	103	111	-8	0	0	0	103	111	-8
5	Ye Htut Kyaw Mining Co.,Ltd	81	81	0	0	0	0	81	81	0
Copper in MT										
		1,444	1,444	0	0	0	0	1,444	1,444	0
1	Myanmar Yang Tse Copper Ltd	1,444	1,444	0	0	0	0	1,444	1,444	0

5.4. Payments of Oil and Gas Transportations Companies:

5.4.1. Cash flows reconciliation by company

The tables below show the differences between the payments reported by Oil and Gas Transportation companies and receipts reported by Government Agencies.

The tables include consolidated figures based on the reporting templates prepared by each company and Government Agency, adjustments made following our reconciliation work and the residual, unreconciled differences:

N°	Company	Per Company			Per Government			Final difference
		Original	Adjust	Final	Original	Adjust	Final	
1	Andaman Transportation Limited (ATL)	7,648,641,212	-	7,648,641,212	-	-	-	7,648,641,212
2	Moattama Gas Transportation Company (MGTC)	250,504,868,063	(99,526,016)	250,405,342,047	254,796,886,604	-	254,796,886,604	(4,391,544,558)
3	Taninthayi Pipeline Company (TPC)	229,111,779,925	-	229,111,779,925	229,300,099,348	-	229,300,099,348	(188,319,423)
4	South-East Asia Gas Pipeline Co (SEAGP)	9,303,847,725	-	9,303,847,725	9,174,558,063	-	9,174,558,063	129,289,662
5	South East Asia Crude Oil Pipeline Co, Ltd (SEACOP)	-	-	-	-	-	-	-
Total payments		496,569,136,925	(99,526,016)	496,469,610,909	493,271,544,015	-	493,271,544,015	3,198,066,893

Amounts in MMK

5.4.2. Cash flows reconciliation by revenue stream

The table below shows total Payments reported by Oil and Gas Transportation companies and Government Agencies, taking into account all adjustments:

N°	Description of payment	Per company			Per Government			Final difference
		Initial	Adjust	Final	Initial	Adjust	Final	
Payments in cash								
	MoF-IRD-Customs Department	298,496,650,676	-	298,496,650,676	295,451,955,043	-	295,451,955,043	3,044,695,633
8	Income Tax (IT)	290,751,878,217	-	290,751,878,217	295,427,873,445	-	295,427,873,445	(4,675,995,228)
12	Withholding tax	7,744,772,459	-	7,744,772,459	24,081,598	-	24,081,598	7,720,690,862
	MOGE	198,072,486,249	(99,526,016)	197,972,960,232	197,819,588,972	-	197,819,588,972	153,371,260
21	Dividend	-	-	-	187,126,459,255	(187,126,459,255)	-	-
22	Training Fund	252,897,276	(99,526,016)	153,371,260	-	-	-	153,371,260
26	Land fees/Dead rent fee	-	995,260,163	995,260,163	10,693,129,717	(9,697,869,555)	995,260,163	-
27	Dividend/Profit Sharing on Oil & Gas transportation	187,126,459,255	-	187,126,459,255	-	187,126,459,255	187,126,459,255	-

Amounts in MMK

N°	Description of payment	Per company			Per Government			Final difference
		Initial	Adjust	Final	Initial	Adjust	Final	
Payments in cash								
29	Road right fee Oil & Gas transportation (Right of way)	9,697,869,555	-	9,697,869,555	-	9,697,869,555	9,697,869,555	-
30	Other material payments (> 50,000 USD)	995,260,163	(995,260,163)	-	-	-	-	-
Social payments								
32 Mandatory Corporate Social Responsibility		4,500,070,258	-	4,500,070,258				
32	Mandatory Corporate Social Responsibility	-	-	-				
33	Voluntary Corporate Social Responsibility	4,500,070,258	-	4,500,070,258				
Total payments in cash		496,569,136,925	(99,526,016)	496,469,610,909	493,271,544,015	-	493,271,544,015	3,198,066,893

5.4.3. Unreconciled discrepancies

Following our adjustments (see Appendix 5), the total unreconciled discrepancies amounted to MMK 3,198,966,020 representing (0.65%) of total payments reported by Government Agencies. This is the sum of positive differences of MMK 7,874,062,122 and negative differences of MMK (4,675,995,228). These unreconciled differences are summarised in the table below:

Amounts in MMK

Reasons for differences	Unreconciled difference
Tax not reported by the Govt Agency	7,898,143,719
Tax not reported by the extractive company	(4,700,076,826)
Total Differences	3,198,066,893

(a) Tax not reported by Government Agency

This difference is related to taxes declared by gems and jade companies as a payment to Government Agencies. However, the Government Agencies didn't report these payments in their reporting templates. The differences are detailed by company and by tax as shown in the table below:

Company	Total	Withholding tax	Training Fund
Andaman Transportation Limited (ATL)	7,648,641,212	7,648,641,212	-
South-East Asia Gas Pipeline Co (SEAGP)	153,371,260	-	153,371,260
Moattama Gas Transportation Company (MGTC)	96,131,248	96,131,248	-
Total	7,898,143,719	7,744,772,459	153,371,260

(b) Tax not reported by the extractive company

This difference is related to taxes declared by Government Agencies as payments from gems and jade companies. However, the companies failed to report these payments in their reporting templates. The differences are detailed by company and by tax as shown in the table below:

Company	Total	Income Tax (IT)	Withholding tax
Moattama Gas Transportation Company (MGTC)	(4,487,675,805)	(4,487,675,805)	-
Taninthayi Pipeline Company (TPC)	(188,319,423)	(188,319,423)	-
South-East Asia Gas Pipeline Co (SEAGP)	(24,081,598)	-	(24,081,598)
Total	(4,700,076,826)	(4,675,995,228)	(24,081,598)

5.5. Transfers from SOEs to MoPF

Following MSG's decision, we reconciled the transfers made by SOE to MoPF and other Government Agencies such as DoM, IRD and Customs department.

A net difference of MMK (773) million was raised between transfers declared by SOEs and revenues received by Government Agencies. Details by SOE are set out in the table below:

Figures in million MMK

SOE	SOE		Government Body		Final difference	
	Transfers to MoPF and DoM	Other accounts - SOE own Accounts	Transfers to MoPF and DoM	Other accounts - SOE own Accounts	Transfers to MoPF and DoM	Other accounts - SOE own Accounts
MOGE	1,031,993	1,179,203	1,031,993	1,179,246	-	(43)
MGE	137,236	112,394	137,236	113,007	-	(613) (1)
ME (1)	4,021	4,365	4,021		-	
ME (2)	14,180	22,319	14,180	54,335	-	(117)
ME (3)	1,627	27,534	1,627		0	
Total	1,189,057	1,345,815	1,189,057	1,346,588	0	(773)

(1) This difference is due to the declaration by MOPF of the balances of MGE "other accounts" used for the collection of the museum fees and incentive fees which have not been declared by MGE.

Individual tax templates by SOE showing the reconciliation are presented in Appendix 8 of this report.

5.6. Production and Exportation:

5.6.1. Oil and Gas

(a) Oil and Gas Production

The table below shows the differences between the production reported by Oil and Gas companies and MOGE.

OFFSHORE Production		Company		MOGE		Difference	
Block	Company	Final		Final		Volumes	
		Oil (Barrels)	Gas (MMscf)	Oil (Barrels)	Gas (MMscf)	Oil (Barrels)	Gas (MMscf)
M5-M6	Total E&P Myanmar	-	293,307	-	293,307	-	-
M12,M13,M14,	PC Myanmar (Hong Kong) Limited	3,071,247	127,845	2,869,870	136,746	201,377	(8,901)
A1,A3	POSCO Daewoo Corporation	-	137,429	-	137,429	-	-
M9	PTTEP International Limited	-	84,102	-	84,102	-	-

ONSHORE Production		Company		MOGE		Difference	
Block	Company	Volumes		Volumes		Volumes	
		Oil (Barrels)	Gas (MMscf)	Oil (Barrels)	Gas (MMscf)	Oil (Barrels)	Gas (MMscf)
MOGE-1	GOLDPETROL JOINT OPERATING COMPANY INC. (GJOC INC.)	593,448		593,448		-	-
IOR-2	GOLDPETROL JOINT OPERATING COMPANY INC. (GJOC INC.)	606,992		606,992		-	-
Mann Oil Field	MPRL E&P Pte Ltd. (Yangon Branch)	543,877	645	543,877	645	-	-

(b) Oil and Gas Exportation

The table below shows the differences between the exports reported by Oil and Gas companies and MOGE.

OFFSHORE Exportation		Company			MOGE			Difference		
Block	Company	Volumes		Value	Volumes		Value	Volumes		Value
		Oil (Barrels)	Gas (MMscf)	USD	Oil (Barrels)	Gas (MMscf)	USD	Oil (Barrels)	Gas (MMscf)	USD
M5-M6	Total E&P Myanmar		216,879	1,822,522,945		216,862	1,811,105,499	-	16	11,417,446
M12,M13,M14,	PC Myanmar (Hong Kong) Limited	1,393,989	127,845	1,587,692,888	1,376,527	127,846	1,500,930,579	17,462	(1)	86,762,309
A1,A3	POSCO Daewoo Corporation		127,963	1,098,609,134		128,135	1,098,546,283	-	(172)	62,851
M9	PTTEP International Limited		57,625	511,982,019		57,625	511,982,019	-	-	-

5.6.2. Gems and Jade

(a) Gems and Jade Production

The table below shows the differences between the production reported by Gems and Jade companies and MGE.

Production Company		Company		MGE		Difference	
		Volume	Unit	Volume	Unit	Volume	Unit
YAR ZA Htar Ne	Gems	-	KG	-	N/A	-	-
	Jade	346,713	KG	346,713	KG	-	-
Myanmar Imperial Jade	Gems	-	KG	-	KG	-	-
	Jade	226,168	KG	670,981	KG	(444,813)	-
WAG	Gems	-	KG	-	-	-	-
	Jade	1,052,305	KG	1,052,305	KG	-	-
MYAT Yamon Gems	Gems	-	KG	-	KG	-	-
	Jade	40,822	KG	40,822	KG	-	-
Si Thu	Gems	-	KG	-	KG	-	-
	Jade	240,895	KG	240,895	KG	-	-
EITI-LLW	Gems	-	KG	-	-	-	-
	Jade	201,771	KG	282,549	KG	(80,778)	-
YADANAR TAUNG TANN	Gems	-	N/A	-	KG	-	-
	Jade	-	N/A	460,625	KG	(460,625)	-
Khin Zaw Aung	Gems	-	KG	-	KG	-	-
	Jade	371,521	KG	381,302	KG	(9,781)	-
Shwe Gaung Gaung Gems	Gems	-	KG	-	KG	-	-
	Jade	365,665	KG	190,398	KG	175,267	-
GMH	Gems	-	KG	-	KG	-	-
	Jade	6,350	KG	-	KG	6,350	-
Richest Gems Co	Gems	-	KG	-	KG	-	-
	Jade	23,620	KG	76,080	KG	(52,460)	-
KYAING INTERNATIONAL GEMS	Gems	-	-	-	-	-	-
	Jade	75,044	KG	75,044	KG	-	-
Phyo Thiha Kyaw	Gems	-	KG	-	KG	-	-
	Jade	45,267	KG	45,267	KG	-	-
Kyaw Naing	Gems	-	KG	-	KG	-	-
	Jade	33,168	KG	37,987	KG	(4,819)	-
HTOO_JEWELLERY_CO	Gems	-	KG	-	KG	-	-
	Jade	16,058	KG	35,905	KG	(19,847)	-

Production		Company		MGE		Difference	
Company		Volume	Unit	Volume	Unit	Volume	Unit
NGwe Hein Htet	Gems	-	KG	-	KG	-	
	Jade	40,631	KG	40,631	KG	-	
lyanshan_jewellery	Gems	111,900	Cr	203,400	Cts	(91,500)	
	Jade	-	Cr	-	Cts	-	
YPPA	Gems	-	KG	-		-	
	Jade	29,977	KG	104,851	KG	(74,874)	
TUN NAING Aung	Gems	-	N/A	-	KG	-	
	Jade	-	N/A	1,851	KG	(1,851)	
Chaow Brothers	Gems	-	KG	-		-	
	Jade	11,995	KG	11,995	KG	-	
1.1.1 Gems & Jewellery Co.	Gems	-	KG	-	KG	-	
	Jade	81,100	KG	81,100	KG	-	
Khun Pa Oh	Gems	-	N/A	3,500	Cts	(3,500)	
	Jade	-	N/A	114,660	KG	(114,660)	
Kachin National Dev	Gems	-	N/A	-		-	
	Jade	390	KG	91,055	KG	(90,665)	
Silver Elephant	Gems	-	N/A	-		-	
	Jade	-	N/A	30,770	KG	(30,770)	
Myo Nwe Gems	Gems	-	KG	-		-	
	Jade	126,083	KG	136,883	KG	(10,800)	
Myanma_Seinn_Lej_Aung_Gems_Co.	Gems	-		-		-	
	Jade	1,004	KG	25,301	KG	(24,297)	
Ruby_Dragon_Jade_&_Gems	Gems	101,014	CARAT	101,014	Cts	-	
	Jade	-	N/A	-		-	
Thi Raw Mani Gems	Gems	-	KG	-		-	
	Jade	54,722	KG	54,722	KG	-	
Kaung Wai Yan	Gems	-	N/A	-	KG	-	
	Jade	-	N/A	2,240	KG	(2,240)	
SHWE Byain Phyu	Gems	-	N/A	-		-	
	Jade	-	N/A	63,233	KG	(63,233)	
Nilar yoma Gems Co.	Gems	159,500	CARAT	159,500	CARAT	-	
	Jade	-	N/A	-		-	
Jade Mountain Gems	Gems	-	KG	-	KG	-	
	Jade	501,880	KG	504,902	KG	(3,022)	
EVER WINNER GEMS COMPANY LIMITED	Gems	-		-		-	

Production		Company		MGE		Difference	
Company		Volume	Unit	Volume	Unit	Volume	Unit
	Jade	38,088	KG	38,088	KG	-	
KMTK	Gems	-		-	KG	-	
	Jade	77,849	KG	77,849	KG	-	
Jade Padhar Gems+Shwe	Gems	-		-		-	
	Jade	51,591	KG	-	KG	51,591	
Khine Myanmar	Gems	-		-		-	
	Jade	187,257	KG	187,257	KG	-	
Kan Pwint Oo Gems & Jewellery	Gems	-		-	KG	-	
	Jade	148,374	KG	146,550	KG	1,824	
Aung Hein Min	Gems	-	N/A	-		-	
	Jade	14,040	KG	5,040	KG	9,000	
Yadanar Yaung Chi G&J	Gems	-	N/A	-		-	
	Jade	-	N/A	307,348	KG	(307,348)	
Tun Tauk Sa Gems	Gems	-	N/A	19,950	cts	(19,950)	
	Jade	-	N/A	-	KG	-	
Sein Long Taung Tan	Gems	-	N/A	-		-	
	Jade	-	N/A	278,365	KG	(278,365)	
Ayar Jade Co; Ltd	Gems	-	N/A	-	cts	-	
	Jade	-	KG	321,946	KG	(321,946)	
Pang Huke Duwa Co; Ltd	Gems	-	N/A	-		-	
	Jade	-	N/A	44,802	KG	(44,802)	
Shinning Star Light	Gems	-	N/A	-	cts	-	
	Jade	-	KG	67,958	KG	(67,958)	

(b) Gems and Jade Sales

The table below shows the differences between the sales reported by Gems and Jade companies and MGE.

Description of payment		Per company				Per Government				Final difference			
		Sales in Euro		Sales in Kyat		Sales in Euro		Sales in Kyat		Sales in Euro		Sales in Kyat	
		Volume	Value €	Volume	Value kyat	Volume	Value €	Volume	Value kyat	Volume	Value €	Volume	Value kyat
Myanmar WIn Gate	Gems									-	-	-	-
	Jade	7,855	26,219,477	-	-	4,528	49,540,959			3,327	23,321,482	-	-
Sein Lom Taung Tan	Gems									-	-	-	-
	Jade	9,377	23,256,771	765,000	3,951,845,212	11,119	38,707,777	760,665	3,920,124,975	(1,742)	-	4,335	31,720,237

Description of payment		Per company				Per Government				Final difference			
		Sales in Euro		Sales in Kyat		Sales in Euro		Sales in Kyat		Sales in Euro		Sales in Kyat	
		Volume	Value €	Volume	Value kyat	Volume	Value €	Volume	Value kyat	Volume	Value €	Volume	Value kyat
										15,451,006			
YAR ZA Htar Ne	Gems									-	-	-	-
	Jade	-		-		10,555	16,866,546	230,950	2,350,448,013	(10,555)	16,866,546	- 230,950	(2,350,448,013)
Myanmar Imperial	Gems									-	-	-	-
Jade	Jade	199,972	71,119,382	14,138	1,478,307,964	205,029	72,358,425	19,526	2,135,996,852	(5,057)	1,239,043	- 5,388	(657,688,888)
WAI AUNG GABAR	Gems									-	-	-	-
GEMS COMPANY LIMITED	Jade	34,600	12,581,447	114,575	1,428,667,100	34,600	12,581,447	127,735	1,509,568,893	-	-	- 13,160	(80,901,793)
AYAR JADE CO	Gems									-	-	-	-
	Jade	-	-	-	-	38,300	12,211,870	120,125	895,600,505	(38,300)	12,211,870	- 120,125	(895,600,505)
MYAT Yamon	Gems									-	-	-	-
Gems	Jade	10,414	11,877,448	140,551	1,550,271,255	11,109	12,008,554	141,261	1,550,271,255	(695)	131,106	- 710	-
Kyauk_Seinn_Naga	Gems									-	-	-	-
r	Jade	51,612	12,451,763	102,547	671,416,356	51,612	12,125,419	103,836	671,416,356	-	326,344	- 1,289	-
Myanmar Si Thu	Gems									-	-	-	-
	Jade	79,865	9,776,469			79,865	9,776,469			-	-	-	-
Linn Lett Win	Gems									-	-	-	-
Yadanar Gems Company Limited	Jade	21,510	9,561,824			11,105	9,561,824	113,069	981,113,962	10,405	-	- 113,069	(981,113,962)
YADANAR TAUNG TANN	Gems									-	-	-	-
	Jade	14,023	21,188,259	81,885	567,005,723	7,585	7,186,292	79,735	560,905,784	6,438	14,001,967	2,150	6,099,939
Khin Zaw Aung	Gems									-	-	-	-
	Jade	8,810	7,948,316			8,810	7,948,316	31,150	677,340,271	-	-	- 31,150	(677,340,271)
Shwe Gaung	Gems									-	-	-	-
Gaung Gems Co.Ltd	Jade	51,857	12,705,009	344,153	1,702,909,047	24,214	6,098,097	372,343	1,811,781,786	27,643	6,606,912	- 28,190	(108,872,739)
Xie_Family_Co.Ltd.	Gems									-	-	-	-
	Jade	24,015	5,966,234			24,015	5,966,234	-	-	-	-	-	-
Great Genesis	Gems									-	-	-	-
Gems Co.,Ltd	Jade	2,525	4,917,144			2,525	4,917,144	15,510	182,318,719	-	-	- 15,510	(182,318,719)
Richest Gems Co	Gems									-	-	-	-
	Jade		5,110,751		360,071,207	34,419	5,110,751	24,895	363,071,207	(34,419)	-	(24,895)	(3,000,000)
Kyaing International	Gems									-	-	-	-
	Jade	1,193	3,815,577	30,502	374,911,073	439	3,815,577	293,030	1,213,262,142	755	-	- 262,528	(838,351,069)

Description of payment		Per company				Per Government				Final difference			
		Sales in Euro		Sales in Kyat		Sales in Euro		Sales in Kyat		Sales in Euro		Sales in Kyat	
		Volume	Value €	Volume	Value kyat	Volume	Value €	Volume	Value kyat	Volume	Value €	Volume	Value kyat
Phyo Thiha Kyaw	Gems									-	-	-	-
Gems	Jade	13,579	4,320,173	62,264	463,598,105	13,579	4,321,403	62,264	463,598,105	-	1,230	-	-
Kyaw Naing	Gems									-	-	-	-
	Jade	2	8,733,772			268	13,099,999	2,827	202,535,886	(266)	4,366,227	-	2,827 (202,535,886)
HTOO_JEWELLER Y_CO	Gems									-	-	-	-
	Jade	1,547	6,105,793			1,547	6,105,793	5,970	28,579,231	-	-	-	5,970 (28,579,231)
NGwe Hein Htet	Gems									-	-	-	-
	Jade	5	9,582,300			1,379	9,639,809	-	-	(1,375)	57,509	-	-
lyanshan_jewellery	Gems	201,825	1,635,277			223	347,937			201,603	1,287,340	-	-
	Jade	3,102	804,229			3,102	1,635,277	6,447	662,377,883	-	831,048	-	6,447 (662,377,883)
Yadanar Pyi Phyo Aung Gems & Jewellery Company Limited	Gems									-	-	-	-
	Jade	12,809	9,227,847			2,360	9,227,847	11,339	444,579,264	10,449	-	-	11,339 (444,579,264)
PAING PHYO THIHA GEMS CO	Gems									-	-	-	-
	Jade	285	8,900,008			260	8,900,008			25	-	-	-
Eighty Thousand Gems	Gems									-	-	-	-
	Jade					2,510	8,080,007	9,649	699,256,825	(2,510)	8,080,007	-	9,649 (699,256,825)
TUN NAING Aung	Gems									-	-	-	-
	Jade	2,150	9,260,471			2,147	8,482,694	-	-	3	777,777	-	-
U Kyaw Min	Gems									-	-	-	-
	Jade									-	-	-	-
Chaow Brothers	Gems									-	-	-	-
	Jade	10,150	1,997,258	10,103	168,078,187	10,150	1,997,258	10,103	168,078,187	-	-	-	-
1.1.1 Gems & Jewellery Co.	Gems									-	-	-	-
	Jade	9,762	4,007,139			9,762	4,007,139	137,866	6,793,504,674	-	-	-	137,866 (6,793,504,674)
Oo Ya	Gems									-	-	-	-
	Jade	41,490	4,179,833			42,780	2,199,833	19,280	206,468,603	(1,290)	1,980,000	-	19,280 (206,468,603)
Pank Huke Duwa	Gems									-	-	-	-
	Jade					4,633	1,612,557	19,294	1,032,527,309	(4,633)	1,612,557	-	19,294 (1,032,527,309)
Khun Pa Oh	Gems									-	-	-	-
	Jade	39,128	2,184,221	240,940	562,512,797	32,012	4,032,024	245,156	982,478,249	7,116	-	-	4,216 (419,965,452)

Description of payment		Per company				Per Government				Final difference			
		Sales in Euro		Sales in Kyat		Sales in Euro		Sales in Kyat		Sales in Euro		Sales in Kyat	
		Volume	Value €	Volume	Value kyat	Volume	Value €	Volume	Value kyat	Volume	Value €	Volume	Value kyat
										1,847,803			
Kachin National Dev	Gems									-	-	-	-
	Jade	390	5,247,612			190	1,660,451	10,040	66,111,000	200	3,587,161	-	10,040 (66,111,000)
Silver Elephant	Gems									-	-	-	-
	Jade	13,363	11,591,287			7,056	3,818,069			6,307	7,773,218	-	-
Myo Nwe Gems	Gems									-	-	-	-
	Jade	2,372	7,535,105	131,078	2,706,401,881	1,849	5,535,105	43,208	608,492,641	(523)	2,000,000	87,870	2,097,909,240
Myanma Seinn Lei Aung Gems Co.	Gems									-	-	-	-
	Jade	1,004	32,969			787	2,859,796	20,683	140,604,620	217	2,826,827	-	20,683 (140,604,620)
Pho Thar Htoo Gems Company Limited	Gems									-	-	-	-
	Jade	2,547	2,880,865			9,765	2,880,865	11,030	68,132,441	(7,218)	-	-	11,030 (68,132,441)
Ruby_Dragon_Jade & Gems	Gems									-	-	-	-
	Jade	189,269	2,812,728			369	175,886	-	-	188,900	2,636,842	-	-
Thi Raw Mani Gems	Gems									-	-	-	-
	Jade	22,303	3,036,551			9,781	2,630,135	12,898	352,789,488	12,522	406,416	-	12,898 (352,789,488)
Kan Par Ni	Gems									-	-	-	-
	Jade							71,150	1,575,896,777	-	-	-	71,150 (1,575,896,777)
Golden Grate Wall Gems Co.	Gems									-	-	-	-
	Jade					2,045	2,288,997	28,977	142,315,421	(2,045)	2,288,997	-	28,977 (142,315,421)
Kyauk Gyi Gone -	Gems									-	-	-	-
	Jade	2,155	3,706,998			1,725	3,638,998	47,104	3,550,001,586	430	68,000	(47,104)	(3,550,001,586)
Phar Kant Yarzar	Gems									-	-	-	-
	Jade	1,030	1,150,100			1,030	1,150,100	49,260	2,499,540,445	-	-	-	49,260 (2,499,540,445)
Zwe Htet Lwin	Gems									-	-	-	-
	Jade	1,460	3,360,008			1,460	3,360,008	65,845	850,049,490	-	-	-	65,845 (850,049,490)
Lin Yaung Phyar	Gems									-	-	-	-
	Jade	1,243	3,040,598			1,243	3,040,598	58,430	2,080,003,768	-	-	-	(58,430) (2,080,003,768)
Kaung Wai Yan	Gems									-	-	-	-
	Jade	-	278,868	-	-	1,258	203,864	1,226	5,008,999	(1,258)	75,004	-	1,226 (5,008,999)
Yadanar San Shwin	Gems									-	-	-	-
	Jade	8,178	3,286,294			7,752	3,098,406	3,168	284,953,039	425	187,888	(3,168)	(284,953,039)
SHWE Byain Phyu	Gems									-	-	-	-

Description of payment		Per company				Per Government				Final difference				
		Sales in Euro		Sales in Kyat		Sales in Euro		Sales in Kyat		Sales in Euro		Sales in Kyat		
		Volume	Value €	Volume	Value kyat	Volume	Value €	Volume	Value kyat	Volume	Value €	Volume	Value kyat	
	Jade					9,082	1,174,371	43,380	391,227,450	(9,082)	-	-	43,380	(391,227,450)
Nilar yoma Gems Co.	Gems	220,700	271,110			220,700	271,110			-	-	-	-	-
	Jade	-	-							-	-	-	-	-
Jade Mountain	Gems									-	-	-	-	-
	Jade	19,464	2,337,976	298,452	1,854,672,211	17,924	2,303,346	298,452	1,854,672,211	1,540	34,630	-	-	-
Ever Winner	Gems									-	-	-	-	-
	Jade	12,050	8,101,718			522	8,296,655	18,453	740,647,793	11,528	194,937	-	18,453	(740,647,793)
Kaung Myat Thukha Company Limited	Gems									-	-	-	-	-
	Jade	23,805	1,530,690					76,490	317,406,799	23,805	1,530,690	-	76,490	(317,406,799)
Jade Padathar Gems Company Limited	Gems									-	-	-	-	-
	Jade	5,772	6,836,259			5,772	6,836,259	7,857	827,410,676	-	-	-	7,857	(827,410,676)
Khine Myanmar	Gems									-	-	-	-	-
	Jade		1,772,029		442,099,518	5,168	1,772,029	37,505	460,799,594	(5,168)	-	-	37,505	(18,700,076)
Kan Pwint Oo Gems & Jewellery	Gems									-	-	-	-	-
	Jade		934,550			3,747	934,550	167,640	2,037,816,546	(3,747)	-	-	167,640	(2,037,816,546)
KHA YANN MYAY	Gems									-	-	-	-	-
	Jade					281	5,789,996	-	-	(281)	5,789,996	-	-	-
Kyei Lin	Gems									-	-	-	-	-
	Jade	282	602,996			439	680,551	630	165,817,999	(157)	77,555	-	630	(165,817,999)
Aung Hein Min	Gems									-	-	-	-	-
	Jade	3,390	2,449,775	11,295	647,641,691	3,390	2,449,775	11,295	647,641,691	-	-	-	-	-
Yadanar Yaung Chi G&J	Gems									-	-	-	-	-
	Jade					470	1,088,000	31,639	7,575,275,333	(470)	1,088,000	-	31,639	(7,575,275,333)
Yanadar Kaung Kin	Gems									-	-	-	-	-
	Jade	1,840	3,584							1,840	3,584	-	-	-
Big Jade Gems	Gems									-	-	-	-	-
	Jade	12,000	420,000,000			352	1,045,577			11,648	418,954,423	-	-	-
Golden Wallet	Gems									-	-	-	-	-
	Jade					2,257	1,707,996			(2,257)	1,707,996	-	-	-
Tun Tauk Sa Gems	Gems		3,088,166							-	3,088,166	-	-	-

Description of payment	Per company				Per Government				Final difference				
	Sales in Euro		Sales in Kyat		Sales in Euro		Sales in Kyat		Sales in Euro		Sales in Kyat		
	Volume	Value €	Volume	Value kyat	Volume	Value €	Volume	Value kyat	Volume	Value €	Volume	Value kyat	
	Jade					4,776	3,369,672			(4,776)	-	-	-
Myanma Economic Coporation	Gems	201,518	1,147,406			201,518	1,147,406			-	-	-	-
	Jade	4,468	4,827,174			-	-			4,468	4,827,174	-	-

5.6.3. Other Minerals

(a) Other Minerals Production

The table below shows the differences between the production reported by the other minerals companies and MONREC:

Company	Type of mineral produced	Company		MONREC		Difference
		Volume	Unit	Volume	Unit	
Myanmar CNMC Nickel Co; LTD	Ferro Nickel	20,993	MT	90,620	MT	(69,628)
Ruby Dragon Mining Co., Ltd.	Gypsum	10,000	MT	10,400	MT	(400)
	Gold	336	Tical			336
	Antimony	4,895	MT	6,732	MT	(1,837)
Shwe Taung Mining Co., Ltd.	Coal	-	-	42,594	MT	(42,594)
	Line Stone	-	-	44,790	MT	(44,790)
NgweYi Palae Mining Co.,Ltd (*)	Coal	-	-	139,450	MT	(139,450)
	Line Stone	-	-	357,000	MT	(357,000)
	Bauxite	-	-	3,750	MT	(3,750)
	Gypsum	-	-	7,900	MT	(7,900)
Win Myint Mo Industries Co.,Ltd (*)	Lead	904	MT	904	MT	-
	Zinc	383	MT	382	MT	1
Tha Byu Mining Co.,Ltd (*)	Anitimony Ore	-	-	650	MT	(650)
	Anitimony Concentrate	-	-	895	MT	(895)
GPS Joint Venture Co., Ltd. (*)	Lead comcentrate	3,750	MT	3,750	MT	-
Htoo International Industrial Gorup Co.,Ltd	Coal	-	-	6,400	MT	(6,400)
	Line Stone	-	-	36,000	MT	(36,000)
Tun Thwin Mining Co., Ltd	Coal	18,578	MT	18,578	MT	-
Shwe Moe Yan Co.,Ltd	Lead	-	-	570	MT	(570)
Myanmar Yang Tse Copper Ltd (*)	Cathode Copper	32,401	MT	36,003	MT	(3,602)
Sea Sun Star Mining Production & Marketing Co.,Ltd	Copper	-	-	1,495	MT	(1,495)
Eastern Mining Co.,Ltd	Tin & Tungsten	30	MT	-	-	30
Swan Min Htet Mining Co;Ltd	Gold	48	Tical	-	-	48
Delco Co.,Ltd (*)	Tin & Tungsten	342	MT	-	-	342
Kayar Mine Production Co., Ltd	Tin & Tungsten	337	MT	-	-	337
Ye Htut Kyaw Mining Co.,Ltd	Tin & Tungsten	247	MT	-	-	247

(b) Other Minerals Exports

The table below shows the differences between the exportation reported by the other minerals companies and MONREC:

Company	Type of mineral produced	Volume	Unit	Value	Currency	Volume	Unit	Value	Currency	Diff Volume	Diff Value
Myanmar CNMC Nickel Co; LTD	Nickel	20,993	MT	242,297,076	US\$	90,662	MT	23,642,309	US\$	(69,669)	(218,654,766)
Ruby Dragon Mining Co., Ltd.	Antimony	600	MT	3,417,779	US\$	6,732	MT	1,542,100	US\$	(6,132)	1,875,679
Win Myint Mo Industries Co.,Ltd	Lead	1,806	MT	1,518,742	US\$					1,806	1,518,742
	Zinc	754	MT	278,763	US\$					754	278,763
Tha Byu Mining Co.,Ltd	Antimony Ore	800	MT	1,069,000	US\$	800	MT	1,033,200	US\$	800	35,800
GPS Joint Venture Co., Ltd.	Lead concentrate	4,000	MT	2,595,880	US\$	4,000	MT	2,595,880	US\$	-	-
Myanmar Yang Tse Copper Ltd	Cathode Copper	23,125	MT	156,440,718	US\$	30,125	MT	156,440,000	US\$	(7,000)	718
Sea Sun Star Mining Production & Marketing Co.,Ltd	Copper					500	MT	207,000	US\$	(500)	(207,000)
Aung Brother Mining Co;Ltd	Tin & Tungsten	8	MT	65,381,185	MMK					8	65,381,185
Delco Co.,Ltd	Tin & Tungsten	230	MT	2,174,521	US\$					230	2,174,521
Kayar Mine Production Co., Ltd	Tin, Tungsten, Scheelite Mixed	123	MT	1,061,697	EUR					123	1,061,697

5.7. Reconciliation between EITI data and other sources of information

5.7.1. SOEs revenues

The reconciliation between the total revenues collected by each SOE based on their reporting templates compared to the total revenues of each SOE according to their respective annual statements of revenues and expenditure indicated the following discrepancies:

In million MMK

SOE	Revenues collected by SOEs (EITI)	Total revenues SOEs	Difference
MOGE	2,428,650	1,884,439	544,211
MGE	331,329	262,067	69,262
ME 1	4,982	5,107	(125)
ME 2	32,342	34,436	(2,094)
ME 3	28,195	29,321	(1,126)
MPE	14,110	11,541	2,569
Total	2,839,610	2,226,911	612,699

As shown in the table above, the total revenues collected by the Oil and Gas and Gems and sectors according to the EITI reporting templates exceeds the total revenues according to the annual statements of revenues and expenditures.

Regarding the Other Minerals sector the total revenues according to the annual statements of revenues and expenditures exceeds the total revenues according to the EITI reporting templates.

Hence, it appears that there are material discrepancies between the various information sources published and a need for greater detail and consistency of definition and presentation. These material differences emphasise a risk regarding the accuracy of the reported data. These differences shall be analysed and reconciled in order to identify their causes and resolve them.

5.7.2. Gems and Jade production

The total production of Gems and Jade according to the data provided by MOGE when reconciled with the production data in the Gemstone Sector Review published in July 2016 showed the following discrepancies:

Production	EITI data		Gemstone Sector Review data ¹		Difference	
	Volume	Unit	Volume	Unit	Volume	Unit
Gems	11,039,786	Carat	13,631,510	Carat	(2,591,724)	Carat
	8,832	Kg	0	Kg	8,832	Kg
Jade	16,893	Ton	16,683	Ton	210	Ton

As shown in the table above, the production reported by MGE exceeds by 2,591,724 Carat and 8,832 Kg the volume of the production of Gems according to the Gemstone Sector Review. Moreover, the production reported by MGE exceeds by 210 tons the volume of the production of Jade according to the Gemstone Sector Review.

Hence, it appears that there are material discrepancies between the various information sources published and a need for greater detail and consistency of definition and presentation. These material differences emphasize a risk regarding the accuracy of the reported data. These differences shall be analysed and reconciled in order to identify their causes and resolve them.

¹ Source: Gemstone Sector Review – Emma Irwin – July 2016

5.7.3. Gems and Jade production and exports data

According to MGE, the volume of production and Emporium sales of Gems and Jade in FY 2014-2015 is as follows:

	Gems (Carat)	Gems (Kg)	Jade (Ton)
Production	11,039,786	8,832	16,893
Emporium Sales	1,667,416	433	9,576

As shown in the table above, there is an inconsistency between the volume of production and the volume in Emporium sales as the production seems to be much more than the Gems and Jade sold in the Emporium. We noted the same inconsistency when comparing the value of production and the amount of Emporium sale as declared by MGE:

	Gems (in million MMK)	Gems (in million USD)	Jade (in million MMK)	Jade (in million USD)
Production (EITI data)	986.13	0.99	36,733	36.92
Emporium Sales (EITI data)	10,861	10.92	1,126,371	1,132.03

According to the above, the Emporium sales of Gems and Jade amount to USD 1,142.9 million in FY 2014-2015. However, the value of Gems and Jade exports according to CSO amount to USD 1,027.1 million in FY 2014-2015 which is far above the figures declared by MGE in the table above.

Hence, it appears that there are material discrepancies between the various information sources published and a need for greater detail and consistency of definition and presentation. These material differences emphasize a risk regarding the accuracy of the reported data. These differences shall be analysed and reconciled in order to identify their causes and resolve them.

5.7.4. Oil and Gas and Other Minerals exports

The reconciliation of Oil and Gas and Other Minerals exports according to the data provided by MOGE and the mining SOEs with the exports according to CSO raised the following discrepancies:

In million USD

	Exports (EITI)	Exports (CSO)	Difference
Oil & Gas	4,921.0	5,178.6	(257.6)
Other minerals	194.5	442.4	(247.9)
Total	5,115.5	5,621.0	(505.5)

Hence, it appears that there are material discrepancies between the various information sources published and a need for greater detail and consistency of definition and presentation. These material differences emphasize a risk regarding the accuracy of the reported data. These differences shall be analysed and reconciled in order to identify their causes and resolve them.

5.8. Field visit verification

As agreed by the MSG, we conducted a field visit for 3 companies operating in the Gems and Jade sector as follows:

Company	Location	Map Ref	Area
111 Co. Ltd	Kachin State, Phar Kant Township, Saiya , War Kyae'	92- C/6(C.964773)	JV with MGE, 7 Plots- 108 Acres
Great Genesis Gems	Kachin State, Phar Kant Township, War Kye Hmaw , War Kyae'	92- C/6(C.951776)	JV with MGE , 4 Plots- 72 Acres
Myanmar Win Gate	Kachin State, Phar Kant Township	N/C	N/C

The field visit was carried out between 7 and 10 December 2017 in Phar Kant Township in Kachin State. We visited also MGE regional office in Phar Kant Township. The overall objective is to validate data such production data, social payments and tax payments from the selected companies.

In carrying out the field visit, we performed the following procedures:

- trace the tax payments reported in the companies' EITI reporting templates to the related tax payments receipts;
- obtain the minutes of production evaluation committees and trace them to volume and value of production reported by the selected companies in their respective EITI reporting templates. These minutes were also reconciled with the royalties on production reported by companies in their respective EITI reporting templates;
- obtain the financial statements of the companies and check their consistence with the EITI reporting templates;
- obtain the list of social payments made by the companies and check their existence and accuracy on the ground; and
- obtain the production records from the field and trace them to the volume of production reported by the selected companies in their respective reporting templates.

The results of the field visit can be summarized as follows:

- the check of the reported tax payments and production data with the related payments receipts and minutes of the valuation committees revealed many discrepancies mainly due to errors in the reporting and misunderstanding of the reporting instructions. After our meeting with the companies' representatives (111 Co. Ltd and Great Genesis Gems) and discussion of these discrepancies, the companies corrected these errors and submitted revised reporting templates with the correct figures;
- a list of social payments was communicated by 2 companies (Great Genesis Gems and Myanmar Win Gate) during the field visit. We have been able to check the existence of some social payments on the ground. However, we note that none of the selected companies has reported these CSR payments in their EITI reporting templates; and
- the production records obtained from all the companies were hand written and did not mention the date. Therefore, it we were not able possible to trace the volume of production in these records with the EITI reporting templates.

6. OTHER INFORMATION

6.1. Production and exports/Sold declared by SOEs

SOEs were asked to report production for the Fiscal Year 2014-2015. The production reported, is shown in Appendix 6. For Oil & Gas, the estimate of the production value was calculated based on the average price of Oil and Gas exports as declared by MOGE for the Condensate and Gas and based on the Average Price of the Brent in 2014¹ for the Oil.

Aggregated figures as declared by SOE's are detailed in the table below:

	Production (In million MMK)	Export/Sold (In million MMK)
Oil & Gas	6,281,647	4,899,232
Gems & Jade	36,733	1,137,231
Other minerals	478,293	193,599
Extractive Sector	6,796,673	6,230,062

The chart below compares the production to exports in terms of value by sub-sector.

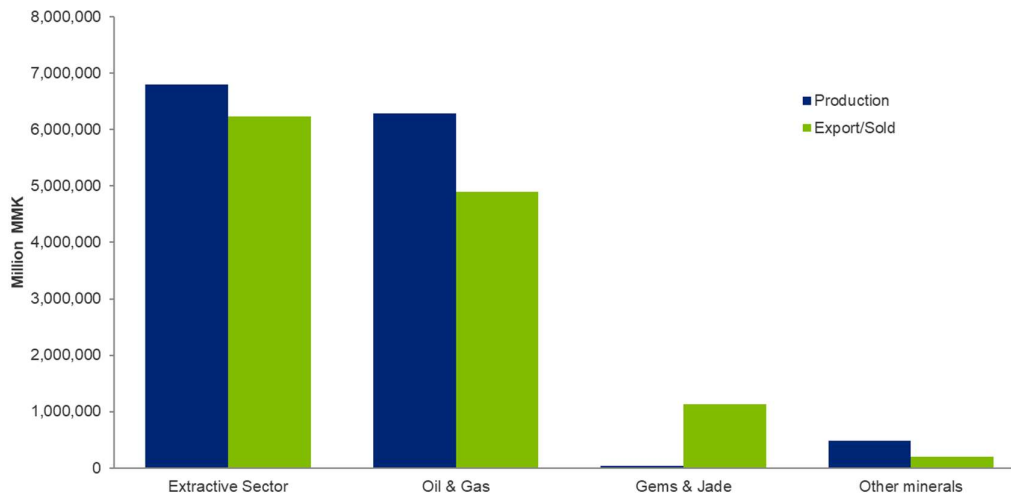

6.2. Government receipts from companies not selected in the reconciliation scope

According to MSG's decisions, SOEs were required to disclose aggregated revenues received from extractive companies not selected in the reconciliation scope. Unilateral revenues received by Government Agencies amounted to MMK 151,193,553,828 and are summarised as follows:

Revenues	Amount in MMK
ME (1)	2,678,951,647
Signature Bonus	244,500,000
Production Split	2,342,894,748
Other significant payments (> 50,000 USD)	91,556,899
ME (2)	1,680,428,000
Signature bonus/Application fees	816,000,000
Other significant payments (> 50,000 USD)	864,428,000

¹ Average Price of the Brent in 2014 is USD 99.02

Revenues	Amount in MMK
ME (3)	2,569,579,880
Signature Bonus	203,000,000
Production Split	2,366,579,880
DoM	3,158,367,617
Royalties	789,811,486
Signature Bonus	26,003,150
Dead Rent Fees	2,340,593,116
Licence Fees	1,959,865
Forest Department	436,454,950
Land rental fees	436,454,950
Custom Departement	2,523,753,672
Customs Duties	2,523,753,672
IRD	12,388,242,044
Commercial Tax	5,448,893,059
Income Tax	6,651,746,114
Withholding Tax	69,850,271
Capital Gain Tax	217,752,600
Sub-total (Other minerals)	25,435,777,809
MGE	133,840,062,446
Royalties on production - 20%	4,397,493,510
Sale Split - 40%	7,636,322,539
Royalties on Sales- 7%	28,379,373,647
Service Fees - 3%, 1%	12,162,588,706
Permit fees	72,073,329,715
Incentive fees 1%, 2%	185,070,361
Other significant payments (> 50,000 USD)	3,645,329,861
Emporium Fees / Sale Fees	5,360,554,108
Custom Departement	4,822,220,928
Customs Duties	4,822,220,928
IRD	29,630,883,582
Commercial Tax	4,569,416,181
Royalty	22,350,747,468
Income Tax	2,091,258,147
Withholding Tax	616,601,787
Capital Gain Tax	2,860,000
Sub-total (Gems& Jade)	168,293,166,957
Pearl	102,145,737
Signature Bonus/ Application Fees	100,455,937
Licence/application Fees	1,689,800
Total unilateral disclosure	193,831,090,504

6.3. Oil & gas transportation volume and tariff

The volume transported by each Oil & Gas transportation company and the average tariff applied in the FY 2014-2015 are as follows:

Company	Volume transported	Unit	Average Tariff rates (USD/MMBTU)	Amount received in cash	Currency
MGTC	200,645	MMSCF	3.4885	78,945.13	million MMK
TPC	101,219	MMSCF	3.2366	102,279.29	million MMK
ATL	84,031	MMSCF	3.3723	No payment in 2014-2015 - Loan repayment period	
SEAGP	182,847	MMSCF	2.8658	-	-

The breakdown by month and by company of the volumes transported is presented in Appendix 13 of the report.

6.4. Revenues from the sale of the State's production share

Reporting entities were requested to report contributions in kind made to or received by Government or State Owned Entities. An in-kind flow is where the Government receives minerals, crude oil or natural gas instead of cash, and monetises the physical commodity in some way. SOEs were also requested to report quantities and revenues received from the sale of the State's production share.

In kind flows

In kind flow as reported by SOE detailed by commodity for the fiscal period 2014/15 are set out in the table below:

SOE	Commodity	Quantity	Unit
MGE	Jade	31,728.00	Kg
ME (2)	Tin	201.70	MT
	Tungsten	1.60	MT
	Tin/Tungsten Mixed	163.40	MT
	Tin/Tungsten /ScheeliteMixed	201.40	MT
	Gold	12,880.30	ToZ
MOGE offshore blocks	Condensate (State share)	535,763.00	Barrel
	Natural Gas I (State share)	81,589.50	MMscf
	Condensate (royalties)	291,037.52	Barrel
	Natural Gas I (royalties)	53,867.21	MMscf
MOGE onshore blocks	Crude oil (State share)	215,255.91	Barrel
	Crude oil (royalties)	78,274.88	Barrel
	Crude oil (Baseline payment)	601,202.65	Barrel
	Crude oil (Risk compensation)	360,364.99	Barrel
	Natural Gas (Baseline payment)	616.85	MMscf
	Natural Gas (Risk compensation)	28.15	MMscf
MPE	Pearl	171,759.70	Momme
	Shell	137.40	Ton

Furthermore, the Gold in-kind debts of the Other Minerals companies due to ME2 amount to 30,813.58 Tical (58,692.53 ToZ) as at 31 March 2015. The breakdown by company is presented in the Appendix 22 of the report.

Revenues from sales**MOGE**

According to MOGE reporting templates, the revenues collected from the Sale of the State's Share of production in offshore blocks amount to MMK 1,403,766 million which represents 59% of the total Oil and Gas revenues in FY 2014-2015. Moreover, the revenues collected from the royalties amount to MMK 393,051 million which represents 16% of the total Oil and Gas revenues in FY 2014-2015.

We understand that according to the PSCs, the State share on production is calculated in volume on the basis of the range of volume produced. The Joint Ventures partners sell all gas revenues in accordance with a long-term gas sales contracts and the revenues received are thereafter allocated on cash basis to MOGE and the partners in accordance to the PSCs provisions.

Furthermore, the revenues collected from the Sale of the State's Share of production in offshore blocks in 2014-2015 are as follows:

Blocks	Volume	Unit	Amount (in USD)	Amount (in million MMK)
Goldpetrol - Yenangyaung	65,729	Barrels	5,606,869	5,580
Goldpetrol - Chauk	149,527	Barrels	12,790,222	12,730
MPRL - Oil	153,241	Barrels	12,555,810	12,496
MPRL - Gas	12	MMscf	19,724	20
Total			30,972,625	30,826

MOGE did not provide the information required by the EITI standard with regards to Sale of the State share of production (individual buying company, unit price, volume sold, country/market destination).

MGE

According to MGE reporting templates, the revenues collected from the Sale of the MGE's Share in Joint Ventures (Sale Split) amount to MMK 122,866 million which represents 31.7% of the total Gems and Jade revenues in FY 2014-2015.

According to the official letter received from MGE, the revenues collected in-kind by MGE as presented in the table above are maintained in the museum or transformed to value added products and not sold in the Emporium. Therefore, no revenues from the sale of this jade are received by MGE in 2014-2015. According to the same official letter the value of these in-kind revenues amount to MMK 38,720.05 million in 2014-2015.

ME 2

Sales of State's share of production operated by ME (2) amounted to MMK 30,390.7 million and is detailed, by Commodity below:

Minerals	Qty	Unit	Amount (in million MMK)
Gold	21,547	ToZ	27,159.55
Tin	181.1	MT	1,532.20
Refined Tin	132.8	MT	1,698.98
Total			30,390.73

The detail of these sales by individual buying entity is as follows:

Gold

No.	Buyers	Date	Payment Voucher	Type of Product	Amount (Kyattha or Toz)	Unit	Value
1	Ministry of Home Affairs	11.4.2014/5.6.2014	22616	Refined Gold	170.88	672,000.00	114.83
2	Department of Myanmar Cinema Development	13.8.2014	138	Refined Gold	18.98	674,000.00	12.79
3	Central Bank	12.9.2014	193	Refined Gold	24,662.38	665,000.00	16,400.48
4	Uppatasanti Pagoda Trustee	19.11.2014	251	Refined Gold	2,187.73	640,000.00	1,400.15
5	Shwedagone Pagoda Trustee	12.11.2014	16	Refined Gold	2,001.17	637,000.00	1,274.75
6	Religious Development Trustee	17.12.2014	302	Refined Gold	97.00	667,000.00	64.70
7	Uppatasanti Pagoda Trustee	24.12.2014	317	Refined Gold	1,001.21	640,000.00	640.77
8	Central Bank	19.2.2015	425	Refined Gold	5,364.00	688,000.00	3,690.43
9	Central Bank	19.3.2015	468	Refined Gold	5,362.42	664,000.00	3,560.65
Total							27,159.55

Tin/Refined Tin

N o.	Buyers	Date	Payment Voucher	Type of Minerals	Amount (Ton)	Price (million MMK)
1	Engineering Director Office	11.7.2014	94	Refined Tin (PRT)	1.74	39.33
2	Weaponry Director Office	16.7.2014	103	Refined Tin (PRT)	0.42	9.42
3	Oo-Saung-Thu Mining Co; Ltd.	26.8.2014	11	Refined Tin	69.98	1,305.92
4	Oo-Saung-Thu Mining Co; Ltd.	26.8.2014	11	Refined Tin/Tungsten	41.57	
5	U Ye Myat Phy (Identification No. - 7/TaKaNa (N) 041894)	22.7.2014	8	Refined Tin (PRT)	19.12	344.32
Sub-total						1,698.98
6	Shwe Lan Kabar Industrial Company	22.8.2014	10	Tin/Tungsten Scheelite Mixed	115.83	1,532.20
7	Shwe Lan Kabar Industrial Company	22.8.2014	10	Tin/Tungsten Scheelite Mixed (Low)	48.77	
8	Shwe Lan Kabar Industrial Company	22.8.2014	10	Tin/Tungsten Mixed (Confiscated)	16.50	
Sub-total						1,532.20
Total						3,231.18

ME 1 and ME 3

ME1 and ME3 did not receive payments in kind and there are no revenues received under this category.

6.5. Transfers from SOEs to Government Agencies

The total revenues collected by oil, gas and mining SOE's for the fiscal year 2014/2015 amounted MMK 2,839,610 million, of which MMK 1,188,859 million was transferred to MoPF (IRD, Customs and Treasury Department), MMK 332,946 million to OGPD (formerly EPD), MMK 7,415 million to Central Committee and MMK 3,227 million to DoM. These transfers include payments made by SOEs under CT, CIT, State contribution and Royalties levied in kind. The receipts and transfers made by SOEs are summarised as follows:

Figures in million MMK

SOE	Amount received by SOE	Transfer from SOE to Gov Agencies during the fiscal year 2014/15					Transfers to SOE other accounts	Total
		IRD-Customs	OGPD (formerly EPD) ¹	Central Committee	DoM	State contributions		
MOGE	2,428,650	745,888	332,946	-	-	286,106	1,179,204	2,544,143
MGE	331,329	75,741	-	7,415	-	61,495	112,395	257,045
ME 1	4,982	2,162	-	-	-	1,860	4,366	8,387
ME 2	32,342	5,607	-	-	3,227	5,346	22,320	36,500
ME 3	28,195	904	-	-	-	723	27,534	29,162
MPE	14,110	1,847	-	-	-	1,180	6,776	9,804
Total	2,839,610	832,149	332,946	7,415	3,227	356,710	1,352,594	2,885,041

6.6. Social Expenditures and Infrastructure Provisions

Companies were requested to disclose social expenditure incurred and infrastructure provisions. Amounts reported are shown in the table below. These amounts were declared unilaterally by the companies and were not included in the reconciliation flows.

No.	Company	Mandatory Corporate Social Responsibility	Voluntary Corporate Social Responsibility	Total
Oil & Gaz		-	4,809,582,527	4,809,582,527
1	Petronas Carigali Hong Kong Ltd	-	812,083,177	812,083,177
2	Daewoo International Corporation	-	1,171,259,302	1,171,259,302
3	Goldpetrol Co Ltd	-	158,798,400	158,798,400
4	MPRL E&P Pte Ltd	-	313,450,321	313,450,321
5	PTTEP International Ltd.	-	913,927,502	913,927,502
6	Unocal Myanmar Offshore Co., Ltd	-	1,266,262,538	1,266,262,538
7	PTTEP South Asia Ltd	-	111,597,527	111,597,527
8	Woodside Energy Pte. Ltd.	-	62,203,760	62,203,760
Oil & Gas Transportation		-	4,500,070,258	4,500,070,258
1	Moattama Gas Transportation Company	-	3,897,313,991	3,897,313,991
2	South-East Asia Gas Pipeline Co (SEAGP)	-	602,756,267	602,756,267
Gems and Jade		-	17,887,000	17,887,000
1	Ngwe Hein Htet Gems & Jewellery	-	6,687,000	6,687,000
2	Lyan Shan Jewellery Co; Ltd.	-	11,200,000	11,200,000
Other Minerals		261,955,000	2,603,427,912	2,865,382,912
1	Myanmar CNMC Nickel Co; LTD	-	383,444,772	383,444,772
2	NgweYi Palae Mining Co.,Ltd	-	201,272,500	201,272,500

¹ These transfers include the royalties, production and signature bonuses as reported by OGDPA

No.	Company	Mandatory Corporate Social Responsibility	Voluntary Corporate Social Responsibility	Total
3	Win Myint Mo Industries Co.,Ltd	-	21,288,840	21,288,840
4	Tun Thwin Mining Co., Ltd	-	29,491,850	29,491,850
5	Shwe Moe Yan Co.,Ltd	261,955,000	-	261,955,000
6	Sea Sun Star Mining Production & Marketing Co.,Ltd	-	70,000,000	70,000,000
7	Eastern Mining Co.,Ltd	-	2,040,000	2,040,000
8	Eternal Mining Co., Ltd	-	148,509,000	148,509,000
9	National Prosperity Gold Production Group Ltd.	-	500,466,069	500,466,069
10	Myanmar Golden Point Family Co., Ltd.	-	239,793,200	239,793,200
11	THAN TAW MYAT CO,LTD	-	24,100,000	24,100,000
12	Delco Co.,Ltd	-	935,731,681	935,731,681
13	Myanmar Pongpipat Co.,L td	-	47,290,000	47,290,000
Total		261,955,000	11,930,967,697	12,192,922,697

The breakdown of the social payments by beneficiary and by project is presented in the Appendix 15 of the report.

6.7. Quasi-fiscal expenditures

SOEs falling under the responsibility of MoEE and MONREC were requested to disclose quasi-fiscal contributions made to Government. Only MOGE declared a domestic gas subsidy for an amount of MMK 181,176,491,619.

6.8. Loans and loan guarantees

SOEs and Government Agencies were requested to disclose the loans and loan guarantees provided to extractive companies with the details of these transactions. Only the Treasury Department within MoPF disclosed the following transactions:

Oil and Gas sector:

Amounts in million

Beneficiary (Name of Entity operating in O&G sector)	Terms of the transaction						Outstanding amount not reimbursed on 31/03/2015	Amount reimbursed during the year
	Date of the Agreement	Maturity period	Interest rate	Currency	Total amount of the loan			
Myanmar Oil & Gaz Enterprise								
(1) China loan								
				USD	80.55	60.38		
				Euro	638.36	603.70		
				RMB	7,358.41	5,148.26		
(i) Drilling Rigs & Oil field Equipments & Materials Project	9/27/2007	15(5)	3%	USD	80.55	60.38		
(ii) Yadanar-Yangon 24" Natural Gas pipeline	9/20/2009	20(5)	4.5%	Euro	185.61	185.61		
(iii) Offshore Natural Gas pipeline Shwe project	11/30/2010	20(5)	4.5%	Euro	334.09	334.09		
(iv) Onshore Natural Gas Pipeline Shwe project	11/30/2010	20(5)	4.5%	Euro	118.66	84.01		
(v) Oil Pipeline Project	11/30/2010	20(5)	4.5%	RMB	7,358.41	5,148.26		
(2) Indian loan								
(i) Yangon-Nyaung Tone Natural Gas Pipeline	10/24/2003	14(5)	1.21688%	USD	7.00	1.72		
(3) Thailand Loan								
Purchase of Machinery & Equipment for Maintenance of Drilling	6/25/2004	12(5)	3%	THB	66.44	14.05		
(4) Japan Loan								
(i) The Offshore Petroleum Exploration & Oil Development Project (MY-CI, JICA)	1/15/2003	40(10)	0.01%	JPY	11,629.73	11,623.88		
(ii) Oil Development Project (NEXI)	10/30/1994	15(0)	1%	JPY	5,370.86	773.04		
Total				USD	87.55	62.10		
				Euro	638.36	603.70		
				RMB	7,358.41	5,148.26		
				THB	66.44	14.05		
				JPY	17,000.58	12,396.92		

Other Minerals:

Amounts in million

Beneficiary (Name of Entity operating in Mining sector)	Terms of the transaction						Outstanding amount not reimbursed on 31/03/2015	Amount reimbursed during the year
	Date of the Agreement	Maturity period	Interest rate	Currency	Total amount of the loan			
I. N0(3) Mining Enterprise								
(i) Japan Loan								
(i) Steel Mill Renovation (MY-CI, JICA)	1/15/2013	40(10)	0.01%	JPY	3,051.09	3,049.552		
Total				JPY	3,051.09	3,049.552		

We understand that these loans are used to fund projects with robust cash flow for which equity funding through mining contracts was not available. These projects have been funded under this shareholder loan agreements signed between the SoEs and the contractors. These agreements are not made public and therefore the sharing mechanisms remain unclear.

Except as provided above, no loans or guarantees were granted during the fiscal year 2014-15 to the extractive companies including Military Holding Companies.

6.9. Infrastructure provisions and barter arrangements

SOEs and Government Agencies were requested to disclose the Infrastructure provisions and barter arrangements with the companies operating in the extractive sector. All the SOEs and Government Agencies did not disclose such arrangements.

7. RECOMMENDATIONS

The recommendations below are based on the findings and weaknesses that we noted during the scoping and reconciliation phases for the preparation of the 2014-2015 MEITI report. In the meantime, many reforms have been implemented in Myanmar and some of them may cover the issues detailed in the recommendations below. Details about the implemented and on-going reforms are presented in Section 3.4.2 of the report. Therefore, the following recommendations must be considered in conjunction with the different reforms being implemented.

7.1. Governance of the extractive revenues

7.1.1 Strengthen the institutional capacities of the IRD

Myanmar has significant mineral and other natural resources which are being extracted widely. However, these resources contributed only about 17.8% of total revenue in 2015-2016. The Asian Development Bank (ADB) estimates that its revenue to GDP is 4.0% in 2011-2012, which is well below the region average and even below the fragile states average of 22%.

Potential revenue from minerals is lost due to:

- weak mineral and other extractive industries revenue collection capacity at the IRD;
- weak mineral and extractive industries revenue policy analysis and revenues forecasting capacities at MoPF;
- weak capacities to monitor compliance with Oil & Gas and mining contracts and verify production amounts, exports, and global prices at the SOEs; and
- lack of an effective extractive industries governance structure to promote transparency, accountability, and responsibility in the management of extractive industries.

Recommendation

Therefore, we recommend:

- *the establishment of an Extractive Industries Revenue Unit within the IRD. The establishment of this unit will enhance the institutional capacity of the IRD to collect adequate revenue from the extractive industries;*
- *to conduct training needs assessment covering the areas of tax audit, risk-based tax audits, data exchange, transfer pricing,*
- *the establishment of procedures and systems to administer extractive industries revenue including an assessment and audit strategy;*
- *to set up a data base of all companies and other entities in the extractive industries for taxation purposes;*
- *to set up a Research Team responsible for drafting research and policy documents; and*
- *to conduct a study on the Harmonisation of Mineral Taxation Regimes and the consolidation of fiscal regulations.*

IRD Comments

Although the reasons contained in the EITI report is partially correct it cannot represent the whole picture of the process. The most important basic principle shall be the Government must have the capabilities to collect the data regarding the extractive industries, auditing of works/accounts, taking action practicing relevant laws. If there are no such capabilities it shall be most difficult for the revenue departments to collect the volume of revenue which should be collected from the relevant extractive industries. The Government has such capabilities only in the Oil and Gas sector. Such capabilities are weak in minerals, gems and forestry resources and the Government's capacity to take action especially in the border areas where many resources are extracted.

For the effective management of extractive industries, the Internal Revenue Department needs to have higher capacities as well as law enforcement and abilities to take action are needed in these areas where these industries are located. Another most important point is more information exchange and cooperation and coordination are needed among the relevant government departments. The present status of information exchange and cooperation and coordination has never reached up to the satisfactory stage.

It is recognized that the Internal Revenue Department is weak in its internal capacity in tax policy and tax governance.

The Internal Revenue Department has been implementing and performing basic reforms in these two areas. Such reforms will help build internal capacity in managing extractive industries. However, it would have to take time to reach up to the stage of effectively managing the extractive industries while capacity building works are rapidly performed.

Suggestions relevant to EITI

To establish a revenue collection unit (Branch) for extractive industries at the Internal Revenue Department (IRD). By establishing such unit, internal capacity of collection of revenue which should be collected from the extractive industries will be enhanced.

Response from the Internal Revenue Department (IRD)

In order to establish the modernized and capable tax revenue management system, and the initial phase of reform programme, the Internal Revenue Department (IRD), Ministry of Planning and Finance has established the LTO (Large Taxpayer Office), which is using the Self-Assessment System since 1st April 2014 after receiving the approval on 30th August 2013. In addition to that the MTO (Medium Taxpayer Office) no. (1) has also been set up and using the Self-Assessment System since 1st April 2017. As these offices are taxpayer offices are the largest taxpayer offices in Myanmar and they are collecting tax revenue not only from the extractive industries but also for the commerce and manufacturing sectors.

Most of the Companies under the extractive industries sector are places in the Large Tax-payer Office (LTO Office). In this LTO Office there are (3) audit teams formed and capacity building training courses for Oil and Gas sector have significantly been provided. Such training courses have been supported by the NORAD. According to the present status/situation there is no sufficient manpower in the Internal Revenue Department to manage all extractive industries. According to the reforms programs, arrangements have been made to implement sustainable capacity building works from time to time. It is reviewed that there can be decrease in the long run by scattering the human resources/manpower and aid and support to (many sectors) even in this condition of less capacity.

EITI Sub-Recommendation (1)

To study and identify the training needs assessment to cover the areas such as the revenue auditing, risk-based tax auditing, data exchanging, transferred pricing.

Response from the Internal Revenue Department (IRD)

Internal Revenue Department has assigned the staffs as per their relative levels to study the tax auditing, transfer pricing, tax reform management training, trainings for the avoidance of double taxation agreement, oil and gas revenue management training, tax policy and expenditures related with tax revenues workshop, policy and activities training, technical support training and more-effective and efficient Integrated Tax Administration System (ITAS) trainings in order to be able to work efficiently and effectively.

All of these training had already been conducted by foreign experts from World Bank, OTA, IMF, NORAD, etc.

After conducting the above-mentioned trainings, the staffs are able to apply the skills and expertise that they learned from the trainings and it enhanced the capacity of staff for sustainable development

The training needs assessment works were conducted and the implementation of reform programs have also been approved. As a result of training needs assessment, the risk-based tax auditing work is provided to be mainly done. The NORAD has provided trainings for the Oil and Gas works

and the auditing works are also practically being performed. Similarly, the World Bank supports the trainings related to transfer pricing. The purpose of these trainings is to do audit efficiently according to the staff qualification/efficiency or to extend the qualification of the staff.

EITI Sub-Recommendation (2)

To establish and perform the procedures and systems including tax supervision and revenue auditing strategy for the collection and management of revenue from the extractive industries

Response from the Internal Revenue Department (IRD)

The audit strategy is already finished and the auditing on the general accounts and auditing on the oil and gas sector has been implemented phase by phase in LTO (Large Taxpayer Office) collaborating with NORAD. Furthermore, the auditing is implementing in line with risk management and the audit manual is already set up. All of these steps are already included in Reform Process and currently implementing on it.

The IRD would like to say that higher efficiency of performance is badly needed for the management as the extractive industries sector is complicated. At present the Internal Revenue Department has no such kind of efficiency.

The auditing strategy has been drawn up and the procedures for general works auditing and oil and gas sector auditing have been provided. It is also important to understand the limitation of efficiency in this part. The individual staff ability must be enhanced and more difficulties can be encountered if starting with more complicated sectors from time to time.

EITI Sub-Recommendation (3)

To establish and perform data base for all companies and firms/teams for revenue collection in the extractive industries sector

Response from the Internal Revenue Department (IRD)

In accordance with the Tax Reform Programme of Internal Revenue Department, Ministry of Planning and Finance 2014-2024, the Data Centre is started establishing in Nay Pyi Taw and Yangon using the ITAS (Integrated Tax Administration System) for taxation. It will be practiced not only for the extractive industries but also for the other industries as per the project: MMPFM (Myanmar Modernization for Public Financial Management). This system will be started in December 2019.

The present running system of the Internal Revenue Department is based on the manual system. At the LTO office, it has been performed with small scale computer system and all organizations under extractive industries sector are recorded. At present the procurement of an Integrated Tax Administration System (ITAS) is under way. Although it takes several years to use in the whole country, a data base system can be drawn up and used for the policy objectives.

EITI Sub-Recommendation (4)

To establish and perform a research team (unit) to undertake to prepare the research and policy papers/reports.

Response from the Internal Revenue Department (IRD)

Internal Revenue Department, Ministry of Planning and Finance restructures the organization in line with the tax reform process as per the meeting decision of Union Government's cabinet meeting no. (12/2014) dated 19 June 2014. There are 11 units in new organization structure and the research and policy department is included as one of the 11 units.

At this moment, a policy division has been established. The IMF team and the NORAD team are also helping this unit to build capacity regarding extractive industries. The re-writing of income tax law in order to build a basic of law to effectively collect the revenue from the extractive industries and the building of capacity are included in their helps. In re-writing the new income tax law the provisions of international revenue collection such as the transfer pricing (not included in the present income tax law) shall be included. Because of this long-term work, it is able to provide certainty, clarity and accuracy for both the tax payer and the Internal Revenue Department (IRD) from time to time.

EITI Sub-Recommendation (5)

To conduct a study and assessment for balanced performance of revenue collection of extractive minerals and integrated performance of financial regulations

Response from the Internal Revenue Department (IRD)

The new income tax law is currently drafting and the extractive industries are included as separated section. Once this new law is enacted, it will be more beneficial and effective for the extractive industries.

7.1.2 Lack of unique Taxpayer Identification Number (TIN) used by all Government Agencies for the identification of the extractive companies

During the scoping phase, we noted that the statements of revenues obtained from MoEE, MONREC, IRD and Customs Department did not include the unique TIN of each company. The names of some companies were spelt differently from one Government Agency to another. These differences may be also due to the translation of these statements from Myanmar to English.

Moreover, we noted that IRD and the Customs Department did not hold a comprehensive list of the extractive companies neither any specific identification number for Oil and Gas and mining companies.

This situation led to:

- IRD and Customs Department identified the extractive companies on the basis of their names which bears a huge risk regarding the comprehensiveness of their statements of revenues;
- because of the differences in the spelling of these names, we were not able to compile the statements of revenues received from these Government Agencies in order to perform a materiality analysis on the basis of total payments made by each extractive company. The analysis of the materiality threshold was done separately for each Government Entity without compiling all the data; and
- IRD and Customs Department were not able to identify some payments made by the extractive companies which led to some differences between their reporting templates and those of the extractive companies. These differences were identified during the reconciliation phase.

Recommendation

We recommend that all the Government Agencies use a unique TIN to record the payments received from extractive companies. This will require continued close cooperation between the different Government Agencies in order to address the situation of existing companies.

With regards to the new companies, the TIN should be allocated at the moment they are set up. The TIN should be communicated to all Government Agencies and should be quoted for every company to avoid any ambiguity.

IRD Comments

Internal Revenue Department has started using the Taxpayer Identification Number (TIN) at (Large Taxpayer Office) LTO using the computer system since financial year 2014-2015 and the use of TIN is being expanded phase by phase at MTO (Medium Taxpayer Office). It is targeted that the new tax management system will be applied to the whole of the Internal Revenue Department on 1 April 2019 during the financial year 2019-2020. On the other hand, not only the extractive industries but also other government agencies related to ITD should use the TIN as same as TIN number used by IRD.

In order to use the same TIN and develop the system, the information technology and network system is required to be installed as well as the new law is needed to be enacted in compliance with the International Standard.

7.1.3 Consider setting a resource revenue sharing system for extractive revenues

Oil, natural gas and mineral revenues are generated in nearly every state and region in Myanmar, with the most important onshore interests lying in Bago, Kachin, Magway, Mandalay, Sagaing, Shan and Tanintharyi. In these areas and others, extractive activities have significantly impacted livelihoods and the local environment.

Taxes and fees collected from extractive companies form part of the State Fund Accounts and are programmed to be spent towards projects and expenses for the entire country. There are no specific projects for which revenues collected from mining companies are allocated to.

Recommendation

Given that local communities are the ones directly affected by extractive activities, the government should consider setting up a special fund arising from revenues earned from extractive companies or revenue sharing mechanisms so that these may be allocated towards projects that would contribute to:

- *the rehabilitation and development of communities impacted by extractive operations.*
- *mitigate or prevent violent conflicts;*
- *respond to local claims for benefits, based on ideas of local ownership; and*
- *promote regional income equality between resource and non-resource rich regions.*

For better transparency and efficiency, the revenue sharing system would require stakeholder consensus on any revenue sharing formula, as well as legal codification.

7.1.4 Lack of transparency of SOEs

Information disclosure and higher standards of accountability in SOEs, when accompanied by other governance reforms such as centralisation of State ownership, listing, board improvements and financial restructuring – can contribute to improved efficiency and performance of SOEs. Information disclosure including both financial and non-financial data is essential for the government, so it can be an effective owner; the Parliament to evaluate the performance of the state as an owner; the media to raise awareness on SOE efficiency; and taxpayers and the general public to have a comprehensive picture of SOE performance.

We understand that MOGE has started to disclose total production figures for each offshore field, amounts for export and domestic use, blocks currently under contract and companies engaged. However, there are still improvements that can be made in transparency and corporate governance. SOEs falling under MoNREC are less transparent than those of the oil and gas sector, although MoNREC is reportedly taking greater steps this year to standardise requirements for SOEs and private companies. SOEs under MoNREC disclose very few details about the joint ventures in which they participate, their revenues, expenditure, or relationships with subcontractors. Moreover, no steps have been taken to make military-affiliated enterprises more transparent or accountable.

Furthermore, the legal nature, powers and duties of SOEs are unclear from publicly available information. Some have dual roles, both as a business partner in operations and as a regulator.

Recommendation

We recommend that MoNREC and MoEE take reasonable steps to publish an annual aggregate report that covers all SOEs and make it a key disclosure tool directed to the relevant stakeholders including the general public, the parliament and the media. The following information may be included in the annual aggregate report:

- *A general statement on the State's ownership policy and information on how the State has implemented this policy (i.e. Information on the organisation of the ownership function as well as an overview of the progress of SOEs, the relationship between SOEs and the Government, SOEs mandate, role in licensing, conflict of interest management);*
- *Aggregate financial information and reporting on changes in SOEs' boards;*
- *Key financial indicators including revenues collected, profit, cash flow from operating activities, gross investment, transfers to the government, spending); and*

- *Information on individual reporting on the SOEs.*

We also recommend to complete the transformation of SOEs and separate their current regulatory function into another part of the MoNREC/MoEE, to remove conflicts of interests, leading to better long-term regulation of the extractive sector.

DoM comments

Although the Ministry of Natural Resources and Environmental Conservation has prepared their step in this year to set out the standard requirements of the State-owned Economic Enterprises and private Companies, the State-owned Economic Enterprises under the Ministry of Natural Resources and Environmental Conservation is less transparent than the Oil and Gas sector. The State-owned Economic Enterprises under the Ministry of Natural Resources and Environmental Conservation are less disclosure on information regarding their joint venture businesses, income, expenditures (or) conditions in relationship with the sub-contractors. Besides there are no performances to be more transparent (or) accountable with the works related to the Military/Tatmadaw (Armed Forces).

According to the information obtained by the general public, the legislation, nature of work, mandates and duties and responsibilities are not clear. In some cases, there are dual roles and responsibilities as business partner as well as regulator in running the businesses.

In the annual consolidated report, the following points may be included and contained:

- (a) General declaration on the information about the State-owned policies and how these policies are being implemented (for example information about who own and how possess and summary of the progress of the State-owned Economic Enterprises, relationship between the State-owned Economic Enterprises and the Government, the mandate of the State-owned Economic Enterprises, the role of obtaining licenses, conflict of interest management)
- (b) Issuance of news regarding the change of Boards of the State-owned Economic Enterprises and consolidated financial information.
- (c) Income collected, profits, income flow from running businesses, net investment, transfer to the Government, financial spending.
- (d) Information regarding the individual reporting on the State-owned Economic Enterprises.

7.2. Management of the Gems and Jade sector

7.2.1 Lack of certification, traceability and valuation of the gemstones

One of the major criticisms NGOs have made of the Jade and Gems sector is that there are inadequate checks throughout the production and distribution process. Based on interviews with a range of stakeholders for the purpose of this report it is estimated that more than half of gemstones produced in Myanmar are not declared and therefore bypass the formal system.

As described in Section 3.3.6 above, the valuation of gemstones in Myanmar is performed by a Valuation Committee which comprises representatives from MGE, other government agencies (IRD, Customs, Parliament), MGJEA and an external expert. The chairman of this committee is an MGE officer. We understand from the meetings held with MGE representatives and from the field visit to the MGE regional office that there are no post independent audits or verifications of the valuation of the gemstones.

The current practices represent a gap with international good practices for gemstone valuation. It is not clear whether the representatives from MGE and the other government agencies have the appropriate skills and market knowledge to independently assess the value of the gemstones. The valuation is restricted to the discretion of MGE and one external expert only.

Furthermore, we note that the process of declaration of gemstone does not follow proper and effective procedures. The only legal provisions on this matter are mentioned in the Gemstone Law which stipulates that “failure to register the rough gemstone produced or failure to register the rough gemstone actually produced and instead registering a substituted rough gemstone shall, on conviction, shall be punished by imprisonment for a minimum of 7 years to a maximum of 15 years, and shall also be liable to a fine” and that non declared gemstones cannot be sold in the Emporium.

Traceability from mines to market in Myanmar need to be improved in order to meet international standards, which demand increasing responsible sources of gemstones, supply chain and ethical and sustainable business models. In the gemstones sector, transparency, traceability and certification are crucial and reflect the increasing global trend towards greater accountability across all economic sectors.

A further issue is that the number of public and private labs in Myanmar which can independently certify gemstones to international standards remains extremely limited.

Recommendations

1. Capacity building

We recommend to perform a capacity review of MGE staff and to consider developing employees’ skills and hiring technically skilled experienced gemstones experts.

MONREC and MGE’s capacity and technical expertise must be strengthened to begin addressing poor monitoring and oversight, which in turn leads to foregone revenue and growth of the informal sector. The capacity of government agency staff to monitor and enforce legal compliance should also be built.

2. Gemstone Governance Framework

We recommend the development of a national Gemstone Sector Policy and a corresponding review of the Gemstone legal framework, to improve governance, including production as well as allocation of permits, valuation, export and sales; and the development of appropriate systems and procedures for the monitoring and reporting of gemstone production.

3. Valuation Procedures

We recommend that MONREC:

- *reviews and strengthens the valuation process of gemstones by involving external values with extensive knowledge of the sector markets and valuation methods and by requiring checks against fair value/market price;*

- opts for a clear description of the valuation method in the minutes of the valuation committee and perform random audits and reconciliations between the valuation of gemstones and their sale prices at the Emporium to determine if there were any shortfalls when collecting the royalties on production.

4. Responsible Mining and Traceability

We recommend that MONREC considers:

- Encouraging gemstone mines to begin adopting international standards for responsible mining, to meet the increasing global demand for responsibly sourced gemstones
- Exploring the future potential of establishing a mine-to-market traceability system, in line with other similar emerging international initiatives (see footnote for some examples¹). The Kimberley Process is an international multi-stakeholder certification mechanism that was established in diamond producing countries to stem the flow of rough 'conflict' diamonds. There are several other international initiatives emerging, most of which focus on diamonds and precious metals (not colored gemstones). Nevertheless, Myanmar may wish to begin engaging in talks with local stakeholders and importing countries to consider the viability of establishing a similar sort of certification process to prevent conflict gemstones from entering the legitimate trade. The creation of an international certification could help in combating the informal sector and breaking the link between the illicit trade in rough gemstone and human rights abuses associated with armed conflict. However, any such activity must be preceded by implementation of other recommendations in this report, including clarification of institutional roles and responsibilities, institutional capacity building, and development of a sector-wide governance framework.

7.2.2 Gemstones sector institutional reform

As described in Section 3.3.6 above, the main role of MGE is to impose taxes in accordance with the Mines Law and Gemstone Law for Gems and Jade production or for the sale of rough and finished products. MGE also participates in Joint Ventures on behalf of the State, manages the Emporium and issues Gems and Jade permits. There is an inherent conflict of interest between its role as a policymaker, a regulator and also as a JV partner.

The existing arrangement does not meet international best practices for governing the State-Owned Enterprises. The cumulation of all these functions coupled with MGE's limited capabilities represent a high risk of conflict of interest.

Human resources capacity is also an issue for MGE in terms of staff with adequate technical skills and experience to manage its varied roles. During our field visit to the MGE regional office in Lone Khin and through our interviews with MGE representatives, we noted that MGE used to allocate three staff members in each production field. Currently, MGE allocates only one staff number in each production field as a result of the limited number of staff.

Recommendation

We recommend to revisit MGE roles in any government considerations of institutional reform in Myanmar's gemstone sector and to adapt them to best international practices. The role of MGE and the other departments under MONREC (DoM, DGSE, etc) should be clearly defined in laws and regulations. The segregation between the role of MGE as regulatory body and its role as partner in JVs should be considered.

¹ The Kimberley Process Certification Scheme <https://www.kimberleyprocess.com/>; The Initiative for Responsible Mining Assurance (IRMA) <http://www.responsiblemining.net/>; The OECD Due Diligence Guidance for Responsible Supply Chains of Minerals from Conflict-Affected and High-Risk Areas <http://www.oecd.org/corporate/mne/mining.htm>; and, The Responsible Jewellery Council (RJC) Code of Practice and Chain of Custody Certification Mechanism for Diamond, Gold and Platinum-Group Metals <https://www.responsiblejewellery.com/about-ric/>

7.3 EITI implementation

7.3.1 Completeness of the data reported on license register

The EITI Standard requires implementing countries to maintain a publicly available register or cadastral system including comprehensive information regarding each of the licenses relating to companies covered in the EITI Report. This register should cover the following information:

- i. license holder(s);
- ii. coordinates of the license area;
- iii. date of application, date of award and duration of the license; and
- iv. in the case of production licenses, the commodity being produced.

Where such registers do not exist or are incomplete, the EITI Report should include the above information.

We noted in certain cases that the list of approved mining and Oil and Gas contracts/permits does not include information about the application date, award date, duration and coordinates of the licensed area.

Recommendation

We recommend that MoNREC and MoEE include systematically these information in the register and for it to be accessible by the public via the ministry's website.

DoM comments

The data regarding the license of minerals sector except the application date are described under the heading of the Department of Mining of the Internet Web Page of the Ministry of Mining www.mining.gov.mm and it has been updated monthly.

7.3.2 Unclear licensing process

The information we received from MONREC and MoEE regarding the licensing process in the Oil and Gas and mining sectors do not disclose clearly the technical and financial criteria used to evaluate the license application. Although a bidding process is used in the Oil and Gas sector, the lack of information about the evaluation criteria and the candidates for each license reduces transparency and opens doors to abuses.

Despite the fact that foreign investors are prohibited by law to have gems and jade licenses and cannot even enter into JVs with nationals and local companies, in practice it is well known that the beneficial owners of many mines are in fact foreigners which reveals the vulnerability of the licensing process.

Recommendation

We recommend that "first come first served" should be the basis for licensing in the mining sector. Competitive procedures should only be applied in the cases where there is detailed geological data available or mineral deposits were proved. In the latter case, the valuation of the bidders should be based on clear technical and financial criteria and identity and beneficial owners of all the candidates should be identified.

DoM Comments

In the minerals sector, the foreign companies are allowed to invest 100% in obtaining license for minerals exploration, testing/surveying, and large-scale production and in cooperation with domestic companies. Foreign investment is not allowed in obtaining licenses for other small-scale and manual (bare earner) production.

The policy of the Ministry up to date is “First Come First Serve” and “Known Deposit” and the provisions is included and enacted in the new Rules such as if the facts are meeting with as the would-be-operator who wish to do is more than one person, many people are interested, tender calling will be conducted. According to the new rules the application for obtaining licenses for minerals exploration/ testing and surveying/ mining shall only be accepted and performed at the Minister’s office and the Department of Mining.

The general public may see and study transparently regarding the License Information after installing the Mineral Cadastre.

7.3.3 Lack of availability and accessibility of information -IRD

One of the identified revenue streams under IRD is withholding taxes arising from interest paid to non-resident foreign nationals, royalty payments to claim owners and purchase of goods and services payments. Final withholding taxes, however, are monitored in aggregate under the current reporting system, irrespective of the extractive companies having withheld the tax. Consequently, IRD disclosures will usually be lower due to the inability to readily extract of withholding taxes details.

Recommendation

We recommend that IRD consider customising certain reports generated from the current system that will enable the further disaggregation of information to facilitate reconciliation for future reports.

IRD comments

As Integrated Tax Administration System (ITAS) is currently implemented, the required data for EITI report will be provided comprehensively once this system has been finalized successfully. It is expected that this system will run for the whole IRD department during April, 2019. Up to now, it is used at LTO and MTO offices. Thus, IRD has already purchased a computer system that can support the detail data for EITI process.

7.3.4 Delayed submission of templates

A total of 89 companies completed and submitted their reporting templates on or before 27 October 2017, the deadline date set by MSG (Please refer to Annex 14 for the details of the non-participating companies).

The low number of responses required frequent follow up by telephone calls and emails to these companies.

As a result of the non-submission of the reporting templates by some of the companies, we were not able to confirm the collections reported by the agencies. This precluded the production of a comprehensive report which accurately and comprehensively reflects the aggregate payments of the companies to the government.

Recommendation

Regulatory mechanisms such as the Foreign Investment Legislation could be used in future to impose EITI disclosure requirements on companies in the extractive industries as the MIC can impose specific conditions on investments.

7.3.5 Improvement in the bidding process for O&G blocks

As part of the EITI process, the government has stated its intention to introduce greater transparency in decision making and better oversight mechanisms. Despite notable improvement in transparency during the most recent onshore and offshore oil and gas bidding rounds, including the public advertising of tenders in English, the selection criteria and decision-making process and Environmental Management Plan (EMP) information remains opaque.

Systematic disclosure of the following additional information would improve the governance of the bidding and selection process:

- *who is mandated to make the decision about awards.*

- *the criteria and priorities for selection of successful bidders (these criteria should be revised to seek information on bidders' commitments to environmental and social sustainability by requiring information on policies and management systems for environmental, social, human rights, health and safety, community engagement);*
- *whether there was a signature bonus paid; and*
- *the evaluation criteria and scoring method applied by MOGE, together with a brief justification for the selection of the chosen operators.*

7.3.6 Improvement in the bidding process for gemstone permits

Gemstone concessions are awarded through competitive bidding. The Myanmar Gems Enterprise (MGE) publishes new opportunities to tender in local newspapers and allows prospective investors one month to survey the concession site. MONREC has not made additional information on the application process available on its website. Mineral licenses are currently awarded on a first-come, first-served basis, although the Gemstone Law opens the door for tenders in future. In both cases, very little published data are available on the selection criteria and decision-making process.

Recommendation

We recommend to review and revise bidding processes for mining concessions in consultation with stakeholders for mining states in a bid to promote openness and fairness. This could include the disclosure of:

- *application procedures including all the required steps;*
- *who is mandated to make the decision about awards;*
- *the criteria and priorities for selection of successful bidders (these criteria should be revised to seek information on bidder's commitments to environmental and social sustainability by requiring information on policies and management systems for environmental, social, human rights, health and safety, community engagement);*
- *data on active mineral licenses by state and by region; and*
- *guidance to be followed in the event of conflicts of interest and corruption which take account of the identities and histories of bidders.*

7.3.7 Creation of a reporting system for employment data

In accordance with the EITI Standard, implementing countries must disclose information about employment in the extractive industries in absolute terms and as a percentage of the total employment.

We note that both MONREC and MoEE do not have a reporting system that would determine the direct impact measured through the jobs attributable to the extractive industry. Thus, employment data collected and stated in this report is partial and does not reflect the comprehensive extractive sector contribution.

Recommendation

In order to improve the accuracy and accessibility of contextual information, we recommend that MoNREC and MoEE periodically (at least annually) update their system with information on the contribution of the industry to labour and employment.

DoM Comments

Although the provisions regarding the appointment of mining employees, assigning works, age, salary and wages and other fees and allowances are set out in the chapter (17) of the 1996 Myanma Mines Rules, arrangement shall be made to collect data regarding the network of labour and employment within the own system for the correct data reflecting the present situation and obtaining more data.

7.3.8 Inaccuracy of production data

We understand that the production data provided by SOEs and departments falling under MoNREC was based on the submissions and declarations from the mining companies. MoNREC does not have its own procedures and systems to collect and control production data provided by the mining companies.

Recommendation

We recommend that the agencies falling under MoNREC set up their own mechanisms, processes and procedures to collect and control production data. Also, it is recommended that the agencies under MoNREC carry out periodic reconciliations of the production volumes declared by the mining companies with the measurements of the agency for each reporting year.

DoM Comments

Since May 2017 the system of monthly reporting of the provision of production target coordinated by both sides before starting the production and the system of field monitoring periodically have been performed.

7.3.9 Lack of availability and accessibility of information on companies social and environmental commitments

We understand that there are no regulations to date that require mandatory/voluntary expenditure and funds to be specifically disclosed in companies and SOEs annual financial statements.

Recommendation

Companies and SOEs could consider publicly disclosing mandatory and voluntary expenditure and funds to ensure full transparency of their social and environmental commitments. Many of these expenditure and funds, if not all, are already disclosed to Government Entities, and would therefore not pose a significant challenge in being made available. Including this information in key public documents such as annual reports, press releases and financial statements, would provide an additional layer of credibility and reliability to the disclosures.

DoM Comments

There are no regulations provided to demand to include the compulsory voluntary expenditure and finance in the annual financial statements of Companies and State-owned Economic Enterprises.

The Companies and State-owned Economic Enterprises may present their compulsory/ voluntary expenditure and finance in order to show their full transparency regarding their commitment on corporate social responsibility.

These data shall be included and described in the public documents such as annual reports, press releases, financial statements etc.

7.3.10 Improving the implementation of projects donated by extractive companies

We understand that donations and infrastructure projects by extractive companies are given directly to ultimate beneficiaries. These are not always reported by either the beneficiaries or the company to the respective State/Regions, and as such, municipalities and regions are not fully aware of the extent of the companies' contributions to extractive regions.

Recommendation

It is recommended that MoEE and MoNREC coordinate with State or regional bodies to keep a record of these projects in order to ensure proper accounting of the value of these contributions and to include them in the development plan of the extractive regions to avoid duplication with the efforts made by the central government.

DoM Comments

It is known that the donation and infrastructure projects by the extractive companies are directly provided to the final beneficiaries. The town/city development departments and the region do not aware such kind of provisions (aid and assistance) for the extractive areas due to never acknowledgement to the relevant Regions and States by both beneficiaries and Company.

The overlapping can be avoided by inclusion of the value/ cost of such projects by recording and including the appropriate calculation to be made by the Ministry of Natural Resources and Environmental Conservation in cooperation with the Departments of Region and State and include in the development plan to be implemented in these extractive regions by the Central Government.

It shall be described in the website by asking separately to the relevant Companies.

7.3.11 Lack of reporting at project level

As noted in Section 4.7, the EITI Standard requires reporting at project level in certain circumstances.

The MEITI Report does not contain this level of disaggregation because Government Entities, SOEs and companies do not allocate revenue streams between projects.

Recommendation

We recommend Government Entities, SOEs as well as extractive companies assess how to disaggregate revenue streams between projects wherever possible, in order to report these revenue streams at project level.

DoM comment

The Government departments, State-owned Economic Enterprises (SOE) and Companies have been reporting the project stage financial affairs.

7.3.12 Extracting Data and Information

The purpose of developing an EITI report is to provide reference to the public and shape better understanding of the reconciliation process. To this end, it is vital that the public obtains information and clarification from parties which are directly involved in the extractive governance.

The team of Reconcilers faced numerous difficulties in obtaining data and confirmations due to:

- *red tape which hindered the data gathering process; and*
- *data and information presented by reporting entities inconsistent with the reporting format.*

As a result, the EITI report was not of the expected quality. Given the constraints we faced, there was not enough time to perform data analysis properly, which could have been informative to users of the report.

Recommendation

Focal points in reporting entities should be encouraged to take more active roles in providing data and information as well as to give comprehensive explanations and confirm elements in EITI report. The reporting format adopted by MSG could be used by reporting entities to start the data collection process, prior the Independent Administrator starting the fieldwork.

7.3.13 MSG to consider expanding scope of future MEITI Reports

The first two MEITI reports relate only to upstream entities (i.e., actual mining and extracting companies) and do not cover sub-contractors, which are part and parcel of the extractive industry.

Although coverage of the gemstone sector has expanded in the two last reports, due to massive informal activity they still cover only a fraction of the whole sector.

We recommend for future reports, that MSG considers:

- *the inclusion of upstream sub-contractors in the extractive sector;*
- *expanding the coverage of the gems and jade sector by applying for Adapted Implementation based on the Gemstone Sector reform plan and including the trading companies in the reconciliation process.*

Recommendation

The main objective for the inclusion of these entities is to provide a more comprehensive assessment of the value chain of these industries and their respective economic contribution.

7.3.14 Sale of the State' share of production

According to the EITI requirement (4.2), "where the sale of the state's share of production or other revenues collected in kind is material, the government, including state-owned enterprises, are required to disclose the volumes sold and revenues received. The published data must be disaggregated by individual buying company. Reporting could also break down disclosures by the type of product, price, market and sale volume."

In case of Myanmar, we understand that according to the Oil and Gas PSCs, the State share on production is calculated on the basis of the total volume produced by the field. The Joint Ventures partners sell all gas revenues in accordance with a long-term gas sales contracts and the revenues received are thereafter allocated on cash basis to MOGE and the partners in accordance to the PSCs provisions. MOGE did not disclose the volume sold and revenues received disaggregated by individual buying company. Information about the price and market destination was not disclosed as well.

Recommendation

We recommend to disclose all the information required regarding the first trade of the State's share of production. This information shall include:

- *the volume and value of each sale operation;*
- *the date;*
- *the type of mineral sold*
- *the identity of the buying company;*
- *the Incoterms;*
- *the individual price of sell; and*
- *the market/destination of the sale.*

7.3.15 Implementation of recommendations from the first MEITI report

The recommendations formulated in the first MEITI Report emphasise the need for reforms in existing reporting mechanisms to promote better transparency through enhancement of data quality, and amendments to legislations and existing regulations.

We understand that the current design of monitoring action plans to address the recommendations and observations raised in the first MEITI report is still being strengthened.

Recommendation

Accordingly, we recommend that MSG implements a formal process to document the review its activities and Government Entities of the recommendations be implemented such as inclusion in the agenda of monthly MSG meetings. Also, review activities can be further re-enforced through adoption of a more structured accountability and reporting lines, as well as fixed timetable for implementation.

7.1. Follow up of the previous recommendations

Recommendations	Implemented (Yes, No, Ongoing, Partially)	Descriptions of the actions maintained
<p>Reliability of the data reported</p> <p>According to EITI Requirements, the reliability of data is one of the critical points for the evaluation of a country's transparency and consequently one of the important criteria during the compliance process.</p> <p>The Office of the Auditor General do not publish any reports relating to audits carried out on Government Agencies. We requested audit reports from OAG for the Government Agencies involved in the extractive sector and these documents are not available for the public.</p> <p><i>With the purpose of ensuring the reliability of financial information relating to the extractive sector in accordance with international standards we recommend to review the regulation to make OAG reports publicly available in order to raise awareness and importance of the extractive sector in Myanmar.</i></p>	Partially	<p>OAG communicated to us all the audit reports of the Government Agencies and SOEs involved in the EITI process for the fiscal years 2014-2015 and 2015-2016.</p> <p>However, these reports are not publicly available.</p>
<p>Delay in issuing CIT payment receipts</p> <p>CIT payment receipts are issued by IRD with considerable delay. In fact, extractive companies do not receive payment receipts upon money transfer. Payment receipts can be issued by IRD with a delay that can reach one month.</p> <p>The gap between the payment/transfer date made by the extractive companies and the accounting records of the IRD causes significant discrepancies in the reported data. Several companies reported CIT final payment for the year 2013-2014 and presented proof that transfers were made during March 2014. The IRD did not report these payments as receipts were issued during April 2014 which is outside the reconciliation period.</p> <p><i>We recommend that CIT payment receipts are issued upon receiving transfers from companies. This will avoid cut-off errors in the reported data. IRD should review the process and identify weaknesses that causes the</i></p>	Ongoing	<p>IRD implemented some actions in order to address the issue of delayed payments receipts related to the payment of the Income Tax. These actions are described in the following IRD comment:</p> <p>IRD comment:</p> <p>IRD has made the following efforts to urge companies for tax compliance:</p> <ul style="list-style-type: none"> - Informed to submit income declaration form - Invited for investigation in accordance with their annual tax payment - Checked the submitted reports - Asked to provide more information if required - If completed, calculated the amount for taxation (need to pass different levels of authorities) - Having calculated the amount to be taxed, recorded in a register and made entries in e-RTS, issued Tax Requisition Form (Pa Ta Kha (oc)-(8) as per the provision 53 of the Income Tax Law and three-folds chalan for payment

Recommendations	Implemented (Yes, No, Ongoing, Partially)	Descriptions of the actions maintained
<p><i>delay in producing the receipts.</i></p>		<ul style="list-style-type: none"> - Companies need to pay taxes at the respective Myanmar Economic Bank once they got a chalan. One piece of chalan is to be kept by the tax payer whereas the other one will be kept by the respective bank and the rest by the respective IRD office. <p>If the tax payer paid the tax in foreign currencies in 2013-2014, they had to pay taxes at Myanmar Foreign Trade Bank (MFTB) or Myanmar Investment and Commercial Bank (MICB), then needed to forward the P.O to the respective IRD offices due to the fact that foreign currency accounts can't be opened up at those offices at that time. Only then has the P.O been received, the IRD offices issue a <i>chalan</i> which states equivalent kyats of cooperate income tax to be paid, whereby tax payers can deposit the tax amount as per the <i>chalan</i> at the nearest Myanmar Economic Bank. That's the main reason of why actual payment date and <i>chalan</i> issued date are different. However, after large taxpayers' office have been set up since 2015, unnecessary bureaucratic procedures are being cut off for tax payers to pay tax more easily.</p>
<p>Reporting deadlines</p> <p>The deadline for reporting template submission from reporting entities was set to 6 November 2015. Four (4) extractive companies and two (2) Government Agencies (IRD and Customs Department) failed to submit their reporting templates on time.</p> <p>This situation caused considerable delays in the reconciliation work and led to additional resources being deployed to try to contact entities and collect reporting templates.</p> <p><i>We recommend for future exercises that the timing of the reconciliation exercise is better planned in order to avoid short deadlines and provide sufficient time for reporting entities to prepare their templates. This is likely to promote better cooperation from reporting entities and they will be available to provide better support to the reconcilers.</i></p>	<p>Yes</p>	<p>In general, the reporting deadlines for the 2014-2015 and 2015-2016 EITI reports have been respected.</p> <p>IRD comment:</p> <p>The IRD couldn't submit the information in MEITI template in time because of the following reasons;</p> <ul style="list-style-type: none"> a) According to the provision 49 of Income Tax Law, the IRD needs to comply with Provision 49; <p>All the particulars appearing in the proceedings dealt with under this law shall be deemed to be of confidential nature. Notwithstanding anything contained in the Evidence Act, no Court shall be competent to summon any public servant to produce such particulars or to give evidence in respect thereof.</p> <p>However, it is liable to do so if the Union Government itself is a complainant of a case or get involved as contestant in the case and the parties official assigned by the government agrees to do so.</p> <ul style="list-style-type: none"> b) No public servant shall disclose such particulars except in the case of a matter relating to the Government.

Recommendations	Implemented (Yes, No, Ongoing, Partially)	Descriptions of the actions maintained
		<p>c) Any public servant who contravenes the above provision shall be prosecuted and if he is found guilty, he may be punished with imprisonment up to six months.</p> <p>In addition, the provision 53 of the Commercial Tax Law states;</p> <p>“In addition to that all the particulars in the proceedings shall be kept confidential by law, the provision 49 of the income tax law shall also effect in this law as well, regarding disclosure of those confidential information, enforcing the public servant to present those information, summoning the public servant to give evidence.”</p> <p>In the light of above points, IRD is liable to provide the information that MEITI requested. However, that information couldn't be provided in due course due to the fact that they need to be checked with some internal procedures for better accuracy.</p> <p>Customs Department comment:</p> <p>It is stated that the Customs Department (CD) didn't submit the implementation status for the Recommendation 7.3 related with the Department in the specified MEITI template in time —before the 6th of November 2015 which was the deadline for submitting the template.</p> <p>It was just to fill up the information regarding exports and imports of Gem and Jade Companies, Mining Companies, and Oil and Gas Companies in the template. However, lack of proper details of those companies in the request letter made us difficult in preparing the information necessary for completing the template and thereby causing to delay in submission of those information at that time.</p> <p>A customs committee for MEITI has been formed as per the departmental order of 335/2017 dated 21st July 2017, to submit customs information if requested, to represent CD in MEITI meetings, to response to the questions regarding oil and gas, and mining sectors.</p> <p>The Director General and members of the customs committee for MEITI hosted a meeting with representatives from the independent auditor group on the 1st of August 2017 as part of the scoping studies visit to Myanmar for EITI reporting and discussed with them about the information that need to be provided by CD for the report. For the time being, the CD is preparing</p>

Recommendations	Implemented (Yes, No, Ongoing, Partially)	Descriptions of the actions maintained
		<p>statistics and information of 1019 Gems and Jade Companies, 1203 Mining Companies and 86 Oil and Gas Companies for the budget year 2014-2015 and 2015-2016 as requested so that those statistics and information can be submitted in time.</p> <p>To conclude, the CD is currently working to do timely submission of the implementation status on the recommendations of the first MEITI report and the statistics and information requested.</p>
<p>Future EITI scope</p> <p>EITI requirement 4 requires the production of comprehensive EITI Reports that include full government disclosure of extractive industry revenues and disclosure of all material payments to government by oil, gas and mining companies.</p> <p><i>We make the following recommendations which MEITI could consider in this context:</i></p> <ul style="list-style-type: none"> • <i>Include the production in the reconciliation process;</i> • <i>extending the coverage of the Gems and Jade sub-sector revenues by including all revenues collected and not only those received from emporium; and study the possibility to include hydro, forestry, fisheries and others;</i> • <i>reconcile revenues collected by SOEs from companies with the transfers made by SOEs to the MoF;</i> • <i>extending the coverage of the report by reducing the materiality thresholds and by considering other relevant criteria for Gems, Jade and other minerals;</i> • <i>include transportation revenues in the reconciliation scope; and</i> • <i>disclosure of social expenditures desegregated by project and beneficiary;</i> <p><i>In setting its annual work plan, MEITI should cover the extractive sector in full and consider the progressive extension of the EITI scope.</i></p>	Partially	<p>The scope of the second and third Myanmar EITI reports was widen by the inclusion of payments from Gems and Jade sector beyond the emporium and the Oil and Gas transportation companies and by reconciling the production and exports data. We understand that Myanmar is preparing its First EITI forestry report as well.</p>

Recommendations	Implemented (Yes, No, Ongoing, Partially)	Descriptions of the actions maintained
<p>Definition of the Beneficial Ownership</p> <p>The 2013 EITI Requirement recommends that beneficial owners of companies which bid for, operate and/or invest in the extractive industries are made public (see below for EITI standard provisions on beneficial ownership). This is a mandatory requirement for government and state owned enterprises, and could become a requirement as from 2016 for private or unlisted public companies, including partners in joint ventures.</p> <p>Myanmar does not currently have a publicly available register of the beneficial owners of the corporate entities that bid for, operate or invest in extractive assets. A brief on the proposed definitions for Beneficial Ownership and Politically Exposed Persons was circulated to Steering Committee members at the MEITI scope validation meeting but has yet to be further discussed at the Committee level.</p> <p>The appropriateness of the beneficial ownership definition proposed in the scoping report needs to be addressed by the MSG on the basis that EITI multi-stakeholders will give their feedback in order to agree the percentage shareholding in a company that a person has to hold or controls in order to qualify as a beneficial owner and take necessary action to implement the beneficial ownership reporting process. The MSG should also agree whether Politically Exposed Persons, who otherwise benefit financially from the company, are also considered to be beneficial owners.”</p> <p>In this connexion and after agreeing the BO definition and reporting process, we recommend that MEITI Secretariat should ensure that reporting entities are made aware of the importance of the BO declaration. Particular attention should be given to the ownership of companies which are not owned by listed companies or SOEs.</p> <p>Furthermore, we strongly recommend that training should be provided to companies on BO reporting requirements. During training, the BO template should be presented and instructions and guidance notes should be provided for the preparation of BO declaration.</p> <p><i>It is also recommended that MSG launches a consultation with Government along with extractive industry companies engaged in the country to agree a standard format for companies to display, substantiate and update ultimate</i></p>	Partially	<p>A definition of Beneficial Owners (BO) and Politically Exposed Persons (PEP) has been set up by MSG for the 2nd and 3rd MEITI reports. The extractive companies include in the scope of reconciliation of these reports have requested to disclose information about BO and PEP. However, MSG decided hat this disclosure is voluntary.</p> <p>We noted that all the companies (when applicable) failed to disclose information about BO and PEP in their reporting templates.</p> <p>There is no register of Beneficial Owners in Myanmar.</p> <p>MOGE comment:</p> <p>A consultative workshop was organized in Novotel Hotel on 23rd and 24th of March 2017 and international companies were also invited to submit their expression of interest for the beneficiary ownership.</p> <p>DICA comment:</p> <ul style="list-style-type: none"> - Disclosing the information of an approved investment project at www.dica.gov.mm within 24 hours after the MIC meeting that approved the project, organizing a press conference, uploading investment information by sectors as well as by countries are being conducted. - List of companies registered at DICA is also being uploaded in the DICA's website (www.dica.gov.mm). - The DICA is coordinating with Mspiral International Design and Web Development Agency for the betterment of the DICA's website thanks to the supports of GIZ. - There is no separate section yet at DICA for registering beneficial owners of the cooperate entities. - According to provision 38 of the Myanmar Investment Rules (MIR) enacted on 30th March 2017, it is mentioned that an investor needs to submit a summary of proposed investment in which it is a must to include information regarding the investor and any other person holding a significant direct or indirect interest in the investment and provide other information as directed by the commission if necessary. - The provision 45 of MIR also states that the commission can publish the summary of the proposal for public awareness.

Recommendations	Implemented (Yes, No, Ongoing, Partially)	Descriptions of the actions maintained
<p><i>beneficial ownership information according to EITI Requirement 3.11. For this purpose, the MSG could consider the setting up of a sub-committee in which Civil Society Organisations, regulators, companies, experts and other stakeholders are represented. This committee will allow for an exchange of information on the effectiveness and future developments of disclosure rules and regulations.</i></p>		<ul style="list-style-type: none"> - In addition, the provision 199 of MIR also calls for publication of an annual report submitted by an investor within three days after submission on the investor's website or DICA's website for public information. <p>MONREC comment:</p> <p>In order to submit a beneficial ownership (BO) road map to the international EITI secretariat office on 31st of December 2015, a road map was drafted in a workshop with the presence of the government, the civil society (MATA), the private sector (MFMA) and Natural Resource Governance Institute (NRGI) on 15th of December 2016 at Royal ACE Hotel in Naypyidaw. The draft BO road map was then reviewed in a two-day review workshop organized at Novotel Hotel in Yangon in last March (23-24 March 2017) by presenting all important stakeholders such as the government, MATA, MFMA and NRGI together with Ms. Gay from EITI secretariat office and Ms. Shona from the World Bank, so as to have the road map finalized. In addition, the ministry is also negotiating with subcommittee and MSG in order to hire a BO Consultant.</p>
<p><u>Military holding companies</u></p> <p>The EITI Standard requires the disclosure by SOE(s) their quasi-fiscal expenditures such as payments for social services, public infrastructure, fuel subsidies and national debt servicing and to develop a reporting process with a view to achieving a level of transparency commensurate with other payments and revenue streams, and which should include SOE subsidiaries and joint ventures. SOEs are also required to disclose their level of beneficial ownership in mining, oil and gas companies operating within the country's oil, gas and mining sector, including those held by SOE subsidiaries and joint ventures, and any changes in the level of ownership during the reporting period.</p> <p>We understand that the two large military holding companies, UMEHL and MEC, hold important positions in Myanmar's economy, including in the mining and gems sectors. We also understand that these two conglomerates which report to the Directorates of the Defence Services are organised under laws which provide protections and privileges to state-based companies. We also understand that until 2014, these companies were exempt from certain taxes</p>	On going	<p>MEC has been selected in the reconciliation scope of the 2014-2015 and 2015-2016 MEITI reports in application of the materiality thresholds described in the Section 4 of this report.</p> <p>Payments received from UMEHL will be included in the report through unilateral disclosure from Government Agencies and SOEs.</p> <p>However, MSG may consider Military Holding companies and their subsidies as specific entities which are risky and therefore should be subject to higher level of scrutiny, including request to submit an auditors' specific attestation, specific interviews, and / or analysis and auditing of specific transactions within their accounts.</p>

Recommendations	Implemented (Yes, No, Ongoing, Partially)	Descriptions of the actions maintained
<p>and contributions applied for private mining companies.</p> <p><i>We recommend to address the issue whether UMEHL and MEC should be treated as SOEs for the next EITI Report and included in the scope, irrespective of the materiality threshold. Accordingly, these companies will be required to disclose:</i></p> <ul style="list-style-type: none"> • <i>prevailing rules and practices regarding their financial relationship with the government;</i> • <i>level of beneficial ownership in mining, oil and gas companies;</i> • <i>payments and contribution to the national budget;</i> • <i>their quasi-fiscal expenditures such as payments for social services, public infrastructure, fuel subsidies and national debt servicing; and</i> • <i>transactions relating to loans or loan guarantees granted to mining, oil and gas companies operating within the country.</i> 		
<p>Publication of statistics and information on the extractive industry</p> <p>The EITI standard stipulates the disclosure of contextual information and regulations in the extractive industry, including the disclosure of:</p> <ul style="list-style-type: none"> • an overview of the extractive industry in terms of reserves, regions, current structure and size, significant exploration activities etc.; • contribution to the economy in terms of employment and export levels; • government revenues generated by the extractive industry and funds earmarked for specific programmes / geographic regions and sub-national transfers; and • public information on license allocations, register of licensees, beneficial owners, contract terms, etc. <p>Currently, Myanmar EITI Secretariat does not have a comprehensive database including extractive operators, contextual information and statistics on the sector. The contextual information in this report was collected from dispersed sources and meetings held with Government Agencies. Most of the information collected is not available to the public. Some analyses were</p>	No	<p>Except the information communicated for the purpose of preparation of the 2nd and 3rd MEITI reports, we did note any progress in the publication of contextual information related to the extractive sector by the Government Agencies.</p> <p>MOGE comment:</p> <p>The Myanmar Investment Commission has already enacted the Myanmar Investment Law, in which how employment shall be done by investors to have a balance between international and local personnel is explained. Besides, taxes gained from extractive companies and SOEs are being paid to the Ministry of Planning and Finance on a monthly basis as well as an annual basis whereas those facts and figures are also being publicized through CSOs.</p> <p>MONREC comment:</p> <p>The statistics and information regarding the government revenues generated from the extractive industry and funds allocated for separated plans; license allocations and registration; law, related rules, orders and instructions and sample contracts have been sent to Moore Stephens that will do independent reconciliation for the second MEITI reporting. That</p>

Recommendations	Implemented (Yes, No, Ongoing, Partially)	Descriptions of the actions maintained
<p>limited due to the lack of statistics in the sector such as employment.</p> <p>We also noted that many figures such as exports and production vary from one source to another (See Section 3.11 of this report).</p> <p><i>In order to enhance the integrity, accuracy, reliability and accessibility of contextual information, we recommend that MEITI Secretariat, MoM, MoE and CSOs publish contextual information at least annually including: the industry potential, the contribution to the economy, the strategy for the sector, relevant events and facts, current regulations and upcoming changes, amongst others.</i></p> <p><i>We also recommend that the MSG assists the EITI Secretariat with adequate resources in order to consider implementing reporting requirements that are similar to the international directives regarding accounting and transparency.</i></p>		<p>information will be officially disclosed to the public once through organizing press conferences and launching event. In addition, the website (www.mining.gov.mm) has been being updated with statistics of cadastral mines licensed by the ministry since May 2015.</p>
<p>Register of licenses</p> <p>The EITI Standard requires implementing countries to maintain a publicly available register or cadastral system including comprehensive information regarding each of the licenses pertaining to companies covered in the EITI Report. This register should cover the following information:</p> <ul style="list-style-type: none"> i. license holder(s); ii. coordinates of the license area; iii. date of application, date of award and duration of the license; and iv. in the case of production licenses, the commodity being produced. <p>We noted that the current permit register has the following weaknesses: i) it is not available online; ii) transfers of mineral rights are not computerised; iv) intensive manual manipulation required to extract the list of licenses; v) licences are not systematically pre-numbered.</p> <p><i>We recommend that the Mining Cadastre ensures that all records are computerised and kept up to date. This would then allow the generation of reports of all licensed operators with relevant details.</i></p> <p><i>An online cadastral system should be installed, which includes information on coordinates of concessions and transfers of mineral rights as well as fees</i></p>	<p>On going</p>	<p>The progress on the implementation of unified Mineral Cadastre System is described if the Section 3.3.16 of the report.</p>

Recommendations	Implemented (Yes, No, Ongoing, Partially)	Descriptions of the actions maintained
<p><i>paid. The MoM and the MoE should have official online cadastre maps with details of licences.</i></p>		
<p>Government accounting systems</p> <p><i>During the reconciliation work, we noted that government accounting systems are not always set up in such a way that it is easy for Government Agencies to provide information required for EITI purposes and to report on a timely basis.</i></p> <p><i>The records in departments and SOEs under the MoF, the MoM and the MoE are kept using manual systems. This made the collection of information time-consuming and prone to error. It also makes management of the information and the control over Government revenues more difficult.</i></p> <p><i>Government Agencies do not use Tax Identification Number. Payments are recorded in most cases using companies' names. In several instances, we noted that payments were allocated to the wrong company because the company name was misspelt or because the company name is similar to other companies. This renders the identification of payments per company laborious as payments can be made by other entities on behalf of the company.</i></p> <p><i>We recommend that the Government introduces appropriate computerised systems to record and control information relating to taxation and revenues. We also recommend that the Myanmar Tax Authorities (IRD and Customs Department) implement the use of Unique Tax Identification Numbers for all taxpayers in order to avoid unnecessary confusion and mistakes. TIN would also lead to information being reported reliably and efficiently.</i></p>	Ongoing	<p>Many reforms with relation to the government accounting system are being implemented by the different Government Agencies. These reforms are as follows:</p> <p>IRD comment:</p> <p>A reform process is being undertaken in IRD to have a modern and effective tax management system installed since 2012 with the supports of international organizations such as IMF, World Bank, ADB, ITIC, JICA, OECD and OTA (USA). Two strategies employed in tax reforms include the transformation of taxation system from OAS to SAS, and from current commercial tax system to value added tax system. Similar to other countries, large taxpayer office (LTO) has been set up to enhance transitions towards SAS system since 1st April 2014 and a counsellor from USOTA has been recruited to help the system be in place. Based on the suggestions of international experts from LTO, taxpayer identification numbers (TIN) have been issued using tax revenue management software (TRMS) as taxation software is not yet ready. Likewise, TINs have been granted to medium taxpayers as well from medium tax payer office (MTO). Besides, TINs are being issued to tax payers who want to start using SAS system in accordance with the tax they pay.</p> <p>In order to develop a digital taxation system, IRD is preparing to procure integrated tax administration system (ITAS), which is a commercial off-the-shelf taxation system based on international taxation standards, with the World Bank loan and supports for Myanmar modernization of public financial management project (M-MPFMp) and with the technical expertise being provided by the tax administration and IT experts from the World Bank and IMF. Electronic taxpayer registration system being part of the ITAS, transitions towards the employment of TIN could be properly implemented in accordance with the tax reform plan.</p> <p>MOGE comment:</p> <p>MOGE has started using a computerized accounting system for salary payments and store accounting in the Head Office and the offices in</p>

Recommendations	Implemented (Yes, No, Ongoing, Partially)	Descriptions of the actions maintained
		<p>Yangon Region. When the Naypyitaw Head Office uses a computerized accounting system for monthly reporting of cash budget, commercial budget, trial balance, etc., to the higher authorities and in preparing annual balance sheet, field offices can only employ a computerized accounting system for other accounts rather than salary payments and store accounts.</p> <p>DICA comment:</p> <p>With regard to the introduction of an appropriate computerized system, information of the companies registered at DICA are being recorded using a company registration software developed by Myanmar Information Technology Co., Ltd.</p> <p>DICA is coordinating with the ADB to implement an electronic registry system.</p> <p>DICA is working closely with Data Focus Co., Ltd. to be able to set up an investment database starting from the budget year 2017-2018.</p> <p>In addition, a FDI Pilot Survey is being conducted in order to have a reliable information with the financial supports of EU-ASEAN COMPASS and the technical supports of IMF.</p> <p>Capacity building trainings are also being provided to the staff for documentation and database development.</p> <p>MONREC comment:</p> <p>Since it is planned to include the information about computerized mining cadaster (MCS) that can record all license information in one place in the second MEITI report, the World Bank has committed to support one million dollars for MEITI implementation in 2017-2018. Evidently, the ministry has learnt that one million dollars has now been budgeted by the bank for MCS. At the same time, Mr Morten Larsen, a mining specialist, and Mr. Jesus Jose Artieda, GIS & Cadaster Consultant from the World Bank visited to the ministry in last October 2016 and conducted a pre-feasibility study for a week in order to implement MCS. In addition, Mr. Morten Larsen and Mr. Chorn Nak, a mining cadaster specialist and consultant, visited again and discussed about MCS at the Department of Mines on 8th of August 2017 and subsequently conducted a knowledge sharing workshop on the following day, followed by a meeting with the responsible ministerial</p>

Recommendations	Implemented (Yes, No, Ongoing, Partially)	Descriptions of the actions maintained
		officials on 11st. Moreover, the ministry is actively participating in sub-committee and MSG to be able to recruit an international mining cadaster consultant.
<p>Budget comprehensiveness and transparency</p> <p>The EITI standard requires that the EITI Report should indicate which extractive industry revenues, are recorded in the national budget and whether these include cash or in-kind payments. When revenues are not recorded in the national budget, the allocation of these revenues must be explained.</p> <p>According to the Union budget for the year 2013/2014, the revenues are detailed by source such as revenues from Ministries and department revenues, State Owned Enterprise Revenues and NPT development committee.</p> <p>The Union budget for FY2013/2014 does not show specific line for the extractive sector revenues. Figures mentioned for each ministry or SOEs are detailed by sector or activity and include total revenue collected from all sectors. As a result, we were not able to determine the contribution of the extractive sector in the State revenues. Furthermore, there is extensive use of “other accounts” in the budgetary system in Myanmar. These ‘other accounts’ are essentially accounts held by ministries and SEEs at the Myanmar Economic Bank (MEB) for management of their own resources. Functioning modalities and use of these accounts were not provided to us. As a result we cannot provide explanation on rules and practices governing transfers of funds between the SOE(s) and the State, retained earnings, reinvestment and third-party financing as requested by Requirement 3.6 of the EITI Standard.</p> <p><i>In order to improve the transparency and comprehensiveness of the budgeting process, we recommend that the Ministry of Finance considers whether own-source revenues from extractive sector could be redefined as normal budgetary revenue and whether more information need to be disclosed with regards to “other accounts” in the budget.</i></p>	Partially	<p>The Union Budget Law does not include details related to the revenues from extractive sector and information about the Other Accounts. However, we understand from the below comments from MoPF that these information are included in the Citizens Budget.</p> <p>MoPF comment:</p> <p>The department expressed its receipt (In Cash) and the material collected by (In Kind) from the mineral resource extractive industries in the Current revenue account issued in the annually published Union Budget Law.</p> <p>According to annual Union Budget Law, the revenue of mineral resources extractive industries sector do not mention a specific topic. However, the related revenue & expenditure of mineral resource extractive industries are expressed in details in Citizens Budget (Citizen's Budget) publication which is intended for citizens to ensure open and transparent Budget and to know the revenue of the extractive industries sectors.</p> <p>The status of the purpose of opening OA Account, the opened patterns of OA Account, the expenditures incurred from OA Account, the payments to OA Account are expressed with the title of financial management of State-Owned Enterprises and other information related to accounts published in the Citizen's Budget plan (2016 - 2017) for the clear public understanding.</p> <p>Regarding the recommendation on the revenue from mineral resource extractive industries, it should be separated and should be described with the title of Normal budgetary. Although the revenue of the State-owned enterprises (SEEs) working as the mineral resource extractive industries displayed together, the revenues details of annual current budget submitted to Ministry of Planning and Finance are listed by title of sale revenue, dividends revenues from the service of partnership contract.</p> <p>Budget Department comment:</p> <p>Incomes, either in-cash or in-kind, from the extractive industries gets published as normal incomes in Union Budgetary Law, which is published</p>

Recommendations	Implemented (Yes, No, Ongoing, Partially)	Descriptions of the actions maintained
		<p>every year.</p> <p>The yearly published budgetary law hasn't yet elaborated the detailed headings of extractive industries from which the incomes were generated. However, Citizen's Budget, that is published to improve budget transparency by highlighting how extractive industries play a role in nation's income, entails incomes and expenditures regarding those extractive industries.</p> <p>To enhance peoples' understanding, information regarding OA Accounts such as the purposes of opening up OA Accounts, the status of those accounts set up so far, the settlement of expenditures from those accounts and how incomes are remitted into the accounts is clearly mentioned with the title namely 'Financial management plan of the State Owned Enterprises (SOE)' in the Citizen's Budget published in 2016-2017.</p> <p>With regard to the recommendation 'to make a separate reporting on incomes from extractive industries as normal budget', though the SOEs doing extractive industries illustrate collective incomes in Union's Budgetary Account, they entail separate incomes items such as sale incomes, benefit shares from joint venture and other incomes in the Normal Budgetary Account, that needs to be submitted to the Ministry of Planning and Finance every year.</p>
<p>Enactment of EITI reporting regulations</p> <p>EITI is established by the Presidential Decree 99/2012 of December 2012 which formally established EITI and states the Government's intention and commitment to implement EITI.</p> <p>However, we understand that the EITI reporting obligations are not covered by any other Law organising the process of collection in the current Legislation. This is one of the main reasons which led to delays to submit EITI reporting templates by some extractive companies and also the lack of contextual information's covering the extractive sector in Myanmar.</p> <p><i>We recommend to develop a legal framework for EITI in Myanmar including an EITI law that can be harmonised with existing legislation. The law can</i></p>	No	

Recommendations	Implemented (Yes, No, Ongoing, Partially)	Descriptions of the actions maintained
<p>include provisions relating to:</p> <ul style="list-style-type: none"> ▪ reporting obligations for extractive companies and Government Agencies alike, while specifying the level of disaggregation of the data to be submitted; and ▪ a time schedule for updating and publishing forms and instructions and selection of the reporting entities and submission of declarations and completion of all reconciliation work. 		
<p>Allocation of licenses</p> <p><i>The EITI standard requires the disclosure of information related to the award or transfer of licenses pertaining to the companies covered in the EITI Report, including: a description of the process for transferring or awarding the license; the technical and financial criteria used; information about the recipient(s) of the license that has been transferred or awarded, including consortium members where applicable; and any non-trivial deviations from the applicable legal and regulatory framework governing license transfers and awards.</i></p> <p><i>The mining legislation does not precise if bidding procedure is to be applied for the award of licences or permits or the application of the principle of “first come, first served”. However, the right to the production permit is guaranteed in case of the discovery of a deposit by the holder of prospecting permit.</i></p> <p><i>We recommend that the MoM reviews the current legislation to state clearly the process used for awarding licenses and when a round of bidding should be conducted with the highest bidder obtaining the concession. This will ensure transparency and could also generate higher revenues.</i></p>	Ongoing	<p>We understand that the new Gemstone Law (actually drafted) will include the procedures for awarding licenses for exploration and production.</p> <p>MONREC comment:</p> <p>First come first serve policy is employed in awarding licenses for exploration of minerals. However, an auction system is practised to award licenses if the proposed exploration areas fall into an area with certain mineral reserve, upon which many investors are of interest. On the other hand, according to the provision 25, Section A of the Myanmar Mines Rules (1996), the ministry shall grant a large scale mine production permit if the application is made by a holder of mineral exploration permit. An auction system was once used in awarding licenses for mineral exploration. However, license renewal and awarding of new licenses have been suspended for the time being. On the other hand, the ministry is planning to include the procedures for awarding licenses for exploration and production in the new gemstone rules that is currently being formulated.</p>
<p>Confidentiality provisions in PSCs</p> <p>The model PSC used by MOE contains confidentiality provisions preventing public disclosure of information relating to Oil & Gas operations by both parties (MOGE and the operators). This issue was addressed by the MOGE before the reconciliation stage by providing to each company selected in the scope a letter of consent allowing them to disclose information about the</p>	Yes	<p>MOGE comment:</p> <p>MoEE will disclose confidential contract information once both parties (MOGE and its contractors) agree to do so even though PSCs between them usually contains confidentiality provisions preventing public disclosure of contract information. The MOEG also provided that information when the first MEITI report was being prepared.</p>

Recommendations	Implemented (Yes, No, Ongoing, Partially)	Descriptions of the actions maintained
<p>amounts paid to MOGE and the MoF.</p> <p><i>However, over the long term such provisions should be amended to allow disclosure for EITI purposes and include an EITI reporting obligation on the operators and MOGE. These amendments should be considered for the forthcoming contracts and those currently being negotiated.</i></p>		
<p>Strengthening transparency at the subnational level</p> <p>We understand that there is no regulation or procedure allowing the distribution of extractive revenues to region/states and local population in Myanmar. We also understand that the influence of illegal mining in the regions is particularly problematic in terms of negative health impacts and environmental effects, poor safety standards and monitoring, and in some cases human rights violations.</p> <p>In order to strength transparency and promoting good governance in extractive sector, we recommend to review the mining regulation in order to setup a fair revenue sharing mechanism of extractive revenues between central and local level.</p> <p><i>It is also useful to reflect the establishment of subnational EITI units in mining regions/states such us Mandalay and Magway regions and Rakhine and Shan states. This process can provide a valuable forum for dialogue at the state/regional level on the distribution/collection of extractive revenues and environmental and social issues associated with the extractive industries. We also recommend the involvement of General Administration Department (GAD) in local resource management, which can further improve local efforts to increase transparency.</i></p>	Ongoing	<p>MONREC comment:</p> <p>The Table 2-F of the 2008 constitution defines the rights of state and regional governments and those have been enacted in the provision 6 and 10 of the amended Myanmar Mines Law (2015). The Law Amending Myanmar Gemstones Law Rules is currently being discussed at the Hluttaws and the ministry is trying to enact a new mine rules.</p>

APPENDICES

Appendix 1: Extractive companies profile

Appendix 1.a. Oil and Gas

No.	Company	Registry Number	Establishment date	Core business activities	Secondary business activities	Capital	Certified FS	Auditor Name
1	Petronas Carigali Hong Kong Ltd (PCML)	21 FC of 1991-92	8/12/1991	Petroleum Exploration / Production	N/A	USD 338.5 Million	YES	U Hla Tun & Associates Limited
2	TOTAL	24FC-1992-1993	3/11/1992	Oil & Gas	N/A	N/C	Yes	U Hla Tun & Associate
3	Daewoo International Corporation	1 FC / 2002-2003	6/17/2002	Exploration, Production and Transportation of Oil and Gas		Not Applicable (Branch Office)	Yes	U Hla Tun & Associates Ltd
4	Goldpetrol Co Ltd	177 FC 97-98	1/4/1998	Exploration and Production of Crude Oil	N/A	USD 1,000	Yes	Daw Win Htay (B.Com, C.P.A, DBL)
5	MPRL E&P Pte Ltd	No. 24 FC	8/7/2000	Exploration & Production of Oil and Gas		Nil (There is no initial capital as MPRL E&P is branch company.)	Yes	Khin Su Htay & Associates Ltd.
6	Nippon Oil	N/C	N/C	N/C	N/C	N/C	N/C	N/C
7	PTTEP International Ltd.	84 FC	19.10.1995	To carry out Exploration and Production of Crude Oil and Natural Gas	N/A	THB 20,000,000	Yes	U Hla Tun & Associates Limited
8	ONGC Videsh Ltd	66FC/2014-2015	25th April 2014	Oil and Gas		50,000,000,000 Rupees	Yes	U Hla Tun & Associates Ltd.
9	Gail JJ India Ltd	GAIL (India) LIMITED	16.08.1984	Gas Marketing	Petrochemicals, Gas Transportation, City Gas, E&P	N/A	Yes	U Hla Tun & Associates Ltd
10	Korea Gas Corporation	N/A	N/A	N/A	N/A	N/A	N/A	120, Cheomdan-ro, Dong-gu, Daegu, Korea
11	Unocal Myanmar Offshore Co., Ltd	9FC of 1994-1995	4/21/1994	Oil & Gas	N/A	N/C	YES	U Hla Tun & Associates Limited
12	Petronas Carigali Myanmar Inc (PCMI)	16 FC of 2011-2012	9/19/2011	Petroleum Exploration / Production	N/A	USD 5,050,000	Yes	U Hla Tun & Associates Limited
13	Geopetrol International Holding Inc	415FC	2/15/2013	N/C	N/C	1000000USD	YES	Stuart Smith
14	Jubilant Oil & Gas Pte.Ltd	N/C	N/C	N/C	N/C	N/C	N/C	N/C
15	PTTEP South Asia Ltd	173 FC	01.11.2012	Exploration and Production of Crude Oil and Natural Gas	N/A	USD 50,000	Yes	U Hla Tun & Associates Limited
16	IsTech Energy EP5 Pte	231FC	11/26/2012	Exploration and Production of Crude Oil and Natural Gas	N/C	19,5Million USD	YES	Stuart Smith
17	Asia Orient International Ltd	N/C	N/C	N/C	N/C	N/C	N/C	N/C
18	CNPC International Ltd	5FC	8/9/2002	N/C	N/C	N/C	YES	Stuart Smith
19	SNOG Pte Ltd	44 FC/2012-13	7/6/2012	Shale Oil Produced from Oil Shale	N/C	N/C	YES	Stuart Smith
20	Eni Myanmar BV	N/C	12/2/2013	Exploration & Production of Crude Oil and Natural Gas	N/A	100,000Eur	YES	UTW
21	Central Asia Oil and Gas (CAOG) Pte. Ltd	1250 FC 2014-2015	3/19/2015	Exploration & Production of Crude Oil and Natural Gas		N/C	Yes	Thida and Partners Ltd

No.	Company	Registry Number	Establishment date	Core business activities	Secondary business activities	Capital	Certified FS	Auditor Name
22	Pacific Hunt Energy Corporation	BC0907646	4/1/2011	Oil & Gas	N/A	CAD 13,899,883	N/C	N/C
23	Bashneft International B.V	786/2014	8/23/2014	Oil and Gas		USD 28,000,000	Yes	Win Thin & Associates
24	Brunei National Petroleum Co	786/2014	8/23/2014	Oil & Gas	N/A	USD 28,000,000	Yes	Win Thin & Associates
25	Petrovietnam Exploration Production Corporation	N/C	N/C	N/C	N/C	N/C	N/C	N/C
26	Oil India Ltd	N/C	N/C	N/C	N/C	N/C	N/C	N/C
27	Ophir Myanmar Ltd	1070 FC/2014-2015	1/29/2015	Exploration & Production of Crude Oil & Natural Gas	N/A	USD 10,000,000	Yes	Myanmar Vigour & Associates Limited
28	Barlanga Myanmar Pte. Ltd.	1249 FC 2014-2015	3/19/2015	Exploration & Production of Crude Oil and Natural Gas		N/C	Yes	Thida and Partners Ltd.
29	Shell Myanmar Energy Pte.Ltd	669FC/2014-2015	9/24/2014	Crude Oil and Natural Gas Exploration and Production	N/A	USD 247,450	Yes	UTW (Myanmar) Limited
30	BG Exploration & Production Myanmar Pte. Ltd.	127FC/ 2015-2016 (YGN)	5/12/2015	Crude Oil and Natural Gas Exploration and Production	N/A	763 890 USD	Yes	UTW Limited
31	Woodside Energy (Myanmar) Pte. Ltd.	680FC/2013-2014	11/29/2013	Exploration and Production of Crude Oil and Natural Gas	N/C	N/C	YES	EY
32	CFG Energy Pte.Ltd.	N/C	N/C	N/C	N/C	N/C	N/C	N/C
33	Reliance Industries Ltd	N/C	N/C	N/C	N/C	N/C	N/C	N/C
34	Statoil Myanmar Pte. Ltd.	116FC/2015-2016(YGN)	N/C	N/C	N/C	N/C	N/C	N/C
35	Tap Energy Pte. Ltd.	N/C	N/C	N/C	N/C	N/C	N/C	N/C

Source: information provided by Extractive companies

NA: Not Applicable

NC: Not communicated

Appendix 1.b. Oil and Gas transportation

Company	Registry Number	Establishment date	Core business activities	Secondary business activities	Capital	Certified FS	Auditor Name
Andaman Transportation Limited (ATL)	13FC	9/8/2011	Exploration and Production of Crude Oil and Natural Gas	N/C	62500USD	Yes	U Hla Tun & Associates Limited
Moattama Gas Transportation Company (MGTC)	121FC-1995-1996	15/12/1995	Oil & Gas	N/A	N/C	Yes	U Hla Tun & Associate
Taninthayi Pipeline Company (TPC)	72 FC of 1997-1998	7/17/1997	Petroleum Exploration / Production		USD 100,000	Yes	U Hla Tun & Associates Limited
South-East Asia Gas Pipeline Co (SEAGP)	17FC	3/20/2011	N/C	N/C	200,000USD	Yes	EY
South East Asia Crude Oil Pipeline Co, Ltd (SEACOP)	N/C	N/C	N/C	N/C	N/C	N/C	N/C

Source: information provided by Extractive companies

NA: Not Applicable

NC: Not communicated

Appendix 1.c. Gems and Jade

N°	Company	Registry Number	Founding date	Core business activities	Secondary business activities	Capital	Certified FS	Auditor Name
1	Myanmar Win Gate Gems & Jewellery Mining	636 / 2007 - 2008	10/10/2007	JADE	no	95,000,000 KS	N/C	N/C
2	Sein Lom Taung Tan Gems Ltd.	1273 of 1996-1997	10/25/1996	N/C		50000000Ks	Yes	Daw Hla Than
3	Yar Za Htar Ne Gems Co;Ltd.	1999/2010-2011	1/11/2011	N/C	N/C	500000000ks	Yes	U Zaw Lwin
4	Myanmar Imperial Jade	NO.919 / 1996-1997	13-9-1996	JADE	no	50000000Ks	Yes	OFFICE OF THE COMMANDER-IN-CHIEF (ARMY) (ACCOUNTS DEPARTMENT)
5	Wai Aung Gabar Gems Co; Ltd.	696/2005-2006	7/18/2005	JADE	no	110500000Ks	Yes	Focus Consulting Group Ltd.
6	Ayar Jade Co; Ltd.	92 /2009-2010	5/5/2009	JADE	no	100,000,000	Yes	U Sein Kyaw Win
7	Myat Yamon Gems Co;Ltd.	1043/1995-1996	12/29/1996	JADE	no	1,370,100,000 Kyats	Yes	Ngwe Inzaly (Audit Firm)
8	Kyauk Seinn Nagar	1630/1999-2000	2/23/2000	JADE	no	140700000ks	Yes	U Kyaw Nyunt
9	Myanmar Sithu Jewellery	448/95-96	11/17/1995	GEMS AND JWEWLLERY	no	500000000ks	Yes	Daw Nyunt Nyunt Yi
10	Linn Lett Win Yadanar Gems	7/2000-2001	4/1/2000	GEMS AND JWEWLLERY	no	2000000000ks	Yes	Ngwe Inzaly Audit Firm
11	Yadanar Taung Tann Gems	787/2000-2001	8/28/2000	N/C	N/C	1000 Lakhs	Yes	Win Group
12	Khin Zaw Aung & Brothers Gems & Jewellery	1117/2007-2008	11/30/2007	GEMS AND JWEWLLERY	no	50000000Ks	N/C	N/C
13	Shwe Gaung Gaung Gems	1385	2/6/1996	GEMS AND JWEWLLERY	no	1000000000ks	Yes	Daw Aye Thidar(NGWE INZALY AUDIT Firm)
14	Xie Family	742/1994-1995	10/13/1994	JADE	no	100 millions ks	Yes	Kyu Kyu Win & Associates Services Co.,Ltd.
15	Great Genesis Gems Co; Ltd.	978/2005-2006	26.8.2005	GEMS AND JWEWLLERY	Business of culturing, production and selling of pearls	3000000000	Yes	Daw Thant Myat Win
16	Richest Gems Co;Ltd.	1047/2007-2008	23.11.2007	GEMS AND JWEWLLERY	no	16,050,00	Yes	Daw Thant Myat Win /Focus Consulting Group (Audit Firm)
17	Kyaing International Gems	872/2007-2008	11/15/2007	GEMS AND JWEWLLERY	no	5000000	Yes	Daw Thant Myat Win(Focus Consulting Group Ltd
18	Phyo Thiha Kyaw Gems	990/2006-2007	15.11.2006	JADE	no	1208600000	Yes	U SAN TUN
19	Myanma Gon Yi Gems & Jewellery	N/C	N/C	N/C	N/C	N/C	N/C	N/C
20	Kyau Naing & Brothers	942/1999-2000	10/8/1999	GEMS AND JWEWLLERY	no	50000000	Yes	Daw Thin Thin Soe
21	Kyay Sin Phyu	4361/2012-2013	17.1.2013	JADE	no	5000000(Kyats)	Yes	Daw Khin Thin Kyu
22	HTOO JEWELLERY CO.,LTD.	737/2007-2008	19.10.2007	JADE	no	3356309506,71ks	Yes	Daw Tin Win Yu
23	Ngwe Hein Htet Gems & Jewellery	128/2004-2005	4/26/2004	N/C		5100000	Yes	Daw Nyunt May
24	Lyan Shan Jewellery Co; Ltd.	357/1995-1996	14.11.1995			800,000,000Kyats	Yes	Focus Consulting Group Ltd
25	Yadanar Pyi Phyo Aung Gems And Jewellery Co; Ltd.	268/2001-2002	6/19/2001	GEMS AND JWEWLLERY		500000000	Yes	Top Intergated Accounting & Consultancy Services
26	PAING PHYO THIIHA GEMS	901/2011-2012	16.6.2011	JADE		101000000 kyats	Yes	U Zin Wai
27	EIGHTY THOUSAND GEMS & JEWELLERY Co;Ltd	2302/2011-2012	10/19/2011	N/C	N/C	2000,000,000	Yes	U Zaw Lwin
28	Tun Naing Aung Gems	164/2002-2003	10.6.2002	JADE	No	16100000 MMK		THAUNG AYE & ASSOCIATES

N°	Company	Registry Number	Founding date	Core business activities	Secondary business activities	Capital	Certified FS	Auditor Name
29	Thit Sar Pan	1066/2012-2013	6/19/2012	N/C	N/C	5000000KS	No	
30	Chaow Brothers Gemstone	462 (1995 - 1996)	20.11.1995	GEMS AND JWEWLLERY	Trading	50000000Ks	Yes	Ma Khin Thin Kyu
31	Mann Ayer Family Co.,Ltd.	286(2013-2014)	2013- April-23	N/C	N/C	N/C	N/C	N/C
32	Gems & Jewellery	312/2006-2007	16.5.2006	JADE		500,000,00	Yes	U Zin Wai
33	Oo Ya Gems & Jewellery Co.,Ltd.	598 / 1999-2000	8/10/1999	N/C	N/C	428880000	N/C	N/C
34	Myanmar Economics Corporation	N/C	4/1/1997	Gems & Jade	no	N/C	N/C	N/C
36	Pang Huke Duwa Co; Ltd.	469/1995-1996	20.11.1995	N/C	N/C	40,000,000 MMK		D Tin Tin Kyaw
37	Khun Pa-Oh Gems & Jewellery	1311/1995-1996	1/29/1996	N/C	N/C	100,000,000	Yes	DAW AYE THIDA (NGWE INZALY AUDIT FIRM)
38	Kachin National Development	938/1995-1996	12/27/2005	JADE	no	100000000ks	yes	Than Than Win & Associates
39	Silver Elephant Gems	NO.190/2001-2002	28.5.2001	N/C	N/C	500000000	Yes	Focus Consulting Group Limited
40	Myo Nwe Gems & Jewellery	432/1999-2000	12.7.1999	JADE	no	1,200,000,000 Kyats		Ngwe Inzaly (Audit Firm)
41	Shining Star Light Gems & Jewellery	220/2004-2005	13.5.2005	JADE	no	3500000000 Kyats		Daw Khin Thinn Kyu(B.com CPA)
42	Myanma Seinn Lei Aung Gems	1675/1999-2000	3/6/2000	N/C	N/C	102,200,00MMK	N/C	N/C
43	Myanmar Naing Group	N/C	N/C	N/C	N/C	N/C	N/C	N/C
44	Pho Thar Htoo Gems Co; Ltd.	252/2003-2004	8/15/2003	JADE	N/C	5000000ks	Yes	NGWE INZALY Audit Firm
45	RUBY DRAGON JADE & GEMS Co.,Ltd	816/1995-1996	12/22/1995	JADE		294000000ks	N/C	N/C
46	Thi Raw Mani Gems & Jewellery	363/ 1995-1996	11/14/1995	N/C	N/C	32000000ks	Yes	KHAING WIN B.COM.C.P.A,D.B.L,D.M.L.Dil
47	Kan Par Ni Gems & Jewellery Co.,Ltd.	2098 / 2005-2006	3/1/2006	N/C	N/C	50000000	N/C	N/C
48	Golden Grate Wall Gems Co., Ltd	1113 / 2006-2007	28.11.2006	N/C	N/C	12200000 (Kyats)	N/C	N/C
49	Kyauk Gyi Gone Gems & Jewellery Co., Ltd	2145 / 2005-2006	3/8/2006	N/C	N/C	50000000	N/C	N/C
50	Phar Kant Yar Zar Gems & Jewellery Co.,Ltd	31 / 2006 -2007	4/5/2006	N/C	N/C	5100000	N/C	N/C
51	Zwe Htet Lwin Gems & Jewellery Co.,Ltd	34 / 2006-2007	4/5/2006	N/C	N/C	5100000	N/C	N/C
52	Lin Yaung Phyar Gems Co.,Ltd	51 / 2006-2007	4/10/2006	N/C	N/C	5100000	N/C	N/C
53	Kaung Wai Yan Gems Co,Ltd	411 / 2005-2006	6/24/2015	gEMS AND JWEWLLERY	N/C	N/C	Yes	N/C
54	Yadanar San Shwin Gems Co., Ltd	1188/2000-2001	13.03.2001	N/C	N/C	100000000ks	Yes	Daw Win San
55	SHWE BYAIN PHYU CO	786	13.3.2003	N/C	N/C	N/C	yes	U Zaw Lwin
56	NILAR YOMA TRADING	1297 / 1995-1996	29.1.1996	N/C	N/C	60100000	No	N/A
57	Jade Mountain Gems Co;Ltd.	203/2000-2001	12.5.2000	JADE	no	1597050000ks	Yes	U SUN TUN
58	Ever Winner Gems	952/1995-1996	12/27/1995	Gems		2000000000ks	Yes	NGWE INZALY AUDIT FIRM
59	Than Lwin Aye Yar Gems Co., Ltd.	780/2014 - 2015	5/19/2014	GEMS AND JWEWLLERY	no	5000000ks	Yes	FOCUS CONSULTING GROUP LTD

N°	Company	Registry Number	Founding date	Core business activities	Secondary business activities	Capital	Certified FS	Auditor Name
60	Jade Padathar Gems + Shwe Gaung Gaung Gems	1161/2003-2004	16.02.2004	JADE		1000000000	Yes	Daw Thant Myat Win
61	Khine Myanmar Gems Co.,Ltd.	155/2004-2005	4/5/2005	N/C	N/C	Kyats-6,350,000	Yes	Daw Aye Thida,Ngwe Inzaly
62	Kan Pwint Oo	792/2002-2003	12.3.2003	JADE	no	Kyats-500,000,000	Yes	U Zin Wai
63	KHA YANN MYAY GEMS	No. 602 of 2011-2012	6/2/2011	N/C	N/C	500000000	Yes	Daw Ohn Mar Yi
64	Kyay Lin	88 / 2000-2001	4/19/2000	N/C	N/C	Ks. 70,00,000	N/C	N/C
65	Kyaw Thet Aung	1025	3/15/2002	N/C	N/C	100,000,000 kyauts		Daw Myat Lwin Moe
67	Aung Hein Min Gems Co.,Ltd	617 (2004 - 2005)	8/2/2004	GEMS AND JWEWLLERY	Trading	50000000	Yes	Ma Khin Thin Kyu
68	YadanarYaungChi Gems Co.,Ltd	67/2008-2009	4/8/2008	N/C	N/C	N/C	N/C	N/C
69	Yadanar Kaung Kin Gems & Jewellery Co.,Ltd	137	2010-2011	JADE	Trading	Ks 10,000,000,000	Yes	Daw San Kyi
70	Big Jade Gems Co.,Ltd.	1249/2007-2008	19.12.2007	N/C	N/C	N/C	Yes	ZIN & FRIENDS
71	Golden Wallet Jewellery Co.,Ltd	620 / 2005-2006	11.7.2005	N/C	N/C	1651200000 (Kyats)	Yes	Daw Khin Thin Kyu
72	Tun Tauk Sa Gems Co.,Ltd.	250/1999-2000	6/16/1999	N/C	N/C	20000000MMK	Yes	N/C

Source: information provided by Extractive companies

NA: Not Applicable

NC: Not communicated

Appendix 1.d. Other minerals

No.	Company	Registry Number	Founding date	Core business activities	Secondary business activities	Capital	Certified FS	Auditor Name
1	Myanmar CNMC Nickel Co.; LTD	NO.4FC/2008-2009	2008.09.23	ferronickel production	NA	855.996million US\$	Yes	Sein Pwint Thit Group ACCOUNTING,AUDITING& CONSULTANCY COPMPANY LIMITED
2	Myanma Economic Corporation	N/A	2002	Gypsum	N/A	210546246.3	Yes	Daw Me Me Haing
3	Ruby Dragon Mining Co., Ltd.	1427/2005-2006	10/10/2005	Antimony, Gold, Gypsum Mining		86100000 Kyat	Yes	U Kyaw Nyunt
4	Shwe Taung Mining Co., Ltd.	1363/2005-2006	10/5/2005	Paluzawa Coal Mine, Kalay District, Sagaing Division		50000000MMK	Yes	Daw Naing Naing San,UTW (Myanmar)
5	NgweYi Palae Mining Co.,Ltd	1299/2004-2005	22.12.2004	Crown Cement	Sin Shwe Li Sugar	K.2,055,000,000		Daw Kyu Kyu Win ,Kyu Kyu Win & Associates Services Co., Ltd.
6	Win Myint Mo Industries Co.,Ltd	1928/2007-2008	39685	Mining	NA	100,000,000 Kyats	Yes	Win Group Certified Accountants
7	Tha Byu Mining Co.,Ltd	1117/2000-2001	15.2.2001	Mining - Antimony Ore	N/A	K.60,000,000	Yes	Thaung Aye and Associates
8	GPS Joint Venture Co., Ltd.	314 FC/ 2012-2013	9.1.2013	Mining -Lead Concentrate	N/A	USD -28120000	No (Still Auditing)	Famat Co.,Ltd
9	Electrum Mining Co; Ltd	876/2010-2011	23.08.2010	N/C		50000000Ks	N/C	N/C
10	Max Myanmar Industry Co.,Ltd	1230/2007-2008	39349	Cement Production	Mining	1,000,000,000 Kyats	Yes	Myanmar Vigour Group
11	Htoo International Industrial Gorup Co.,Ltd	1411/2004-2005	1/11/2005	N/C		50000000Ks	Yes	N/C
12	Tun Thwin Mining Co., Ltd	1340 / 1999-2000	1/3/2000	Coal Mining		500000000	No	N/C
13	Shwe Moe Yan Co.,Ltd	2653/2010-2011	3/24/2011	God		14,629,541,302 MMK	Yes	Royal Treasure Audit Firm (Daw Khin Than Oo)
14	Myanmar Yang Tse Copper Ltd	461/2011	40620	Mining , Mineral Processing and Marketing of Cathode copper	NA	USD 10 million	Yes	Stuart Smith & Allan
15	Sea Sun Star Mining Production & Marketing Co.,Ltd	565/2004-2005	41843	Mining	Marketing	51000000.00Ks	Yes	Yee Noo(Ausit Law Firm
16	Eastern Mining Co.,Ltd	(64 / 2007 - 2008)	6/19/2007	Mining (Tin & Tungsten)	DOC Distribution (Day Old Chick)	Ks. 50,000,000	Yes	Focus Consulting group ltd
17	Swan Yadanar Htay Mining Co;Ltd	1270/2009-2010	12/1/2009	N/C	N/C	N/C	N/C	N/C
18	Swan Min Htet Mining Co;Ltd	1270/2009-2010	12/1/2009	N/C	N/C	N/C	N/C	N/C
19	Aung Brother Mining Co;Ltd	1420/2008-2009	2/4/2009	Production of Tin, tungsten and mixed mineral ore		50000000	yes	Daw Khin Win Yi
20	Eternal Mining Co., Ltd	974 / 2006-2007	13.11.2006	Mining-Gold	NA	K 7,500,000,000	Yes	Maung Maung Hteik & Associates
21	National Prosperity Gold Production Group Ltd.	4327 (2011-2012)	3/15/2012	Gold Mining		10000000000 kyats	yes	Focus Consulting Group Limited (Auditor and Financial Consultants)
22	Geo Asia Industrial and Mining Co., Ltd.	(80/2006-2007)	2006/2007	Gold Mining	NA	NA	NA	NA

No.	Company	Registry Number	Founding date	Core business activities	Secondary business activities	Capital	Certified FS	Auditor Name
23	Myanmar Golden Point Family Co., Ltd.	1955 / 1996-1997	2/24/1997	Gold Mining	NA	K 1,000,000,000	Yes	Maung Maung Htek & Associates
24	THAN TAW MYAT CO.,LTD	1593/2009-2010	2/1/2010	Cement Manufacturing	Limestone Mine	143484.00 Million k	Yes	U Than Aung, B.Com(A.A),C.P.A, HGP, Certified Public Accountant and Auditor
25	BAGAN BUSINESS GROUP	N/C	N/C	N/C	N/C	N/C	N/C	N/C
26	Delco Co.,Ltd	No-556 / 2007-2008	25.9.2007	Mining - Tin & Tungsten Production	Mining - Tin & Tungsten Export	K.500,000,000	Yes	Focus Consulting Group Ltd.
27	Myanmar Pongpipat Co.,L td	10FC/1999-2000	8/12/1999	Mining - Tin Concentrates	N/A	K.6000,000	Yes	Daw Than Than Win
28	Kayar Mine Production Co., Ltd	762/2002-2003	28-2-2002	Mining -Tin-Tungsten Scheelite mixed concentrate	N/A	K.52040000	yes	Commander-in-chief(Army)Account Dept
29	Ye Htut Kyaw Mining Co.,Ltd	1229/2009-2010	11/24/2009	N/C	N/C	500,000,000 ks	YEs	Commander-in-chief(Army)Account Dept

Source: information provided by Extractive companies

NA: Not Applicable

NC: Not communicated

Appendix 2: Legal ownership

Appendix 2.a. Oil and Gas

N°	Company	N°	Name/Entity	Level of ownership	Nationality of the owner	Stock exchange quotations (yes/no)	Stock exchange	Owner (if the company's shares are not quoted)
1	Petronas Carigali Hong Kong Ltd (PCML)	1	PC (Myanmar) Holding Limited	100%	Hong Kong	No	N/A	N/C
		2	PETRONAS International Corporation Limited	0%	Malaysia	No	N/A	N/C
2	TOTAL	1	Total E&P Myanmar	100%	French	Yes	Paris	N/A
3	Daewoo International Corporation	1	POSCO DAEWOO Corporation	100%	N/C	No	N/A	N/A
4	Goldpetrol Co Ltd	1	Goldwater Company Limited	60%	Indonesia	Yes	Subsidiary of Interra Resources Limited which is listed in SGX	N/A
		2	North Petrol Operating Inc.	40%	China	No	N/A	N/A
5	MPRL E&P Pte Ltd	1	MPRL E&P Pte Ltd.	100%	British Virgin Island	No	N/A	N/C
6	Nippon Oil	N/C	N/C	N/C	N/C	N/C	N/C	N/C
7	PTTEP International Ltd.	N/C	N/C	N/C	N/C	N/C	N/C	N/C
8	ONGC Videsh Ltd	1	ONGC Videsh Limited	97%	Indian	No	N/A	N/C
		2	M&S Limited	3%	Myanmar	N/C	N/C	N/C
9	Gail JJ India Ltd	1	Government of India	56%	Indian	N/A	N/A	N/A
		2	Public + GDR, ADR	44%	N/C	N/C	N/C	N/C
10	Korea Gas Corporation	1	KOREA GAS CORPORATION	100%	N/C	N/C	N/C	N/C
11	Unocal Myanmar Offshore Co., Ltd	1	Chevron Global Ventures, Ltd.	100%	Bermuda	No	N/A	N/A
12	Petronas Carigali Myanmar Inc (PCMI)	1	PETRONAS International Corporation Limited (PICL)	100%	Malaysia	No	N/C	N/C
13	Geopetrol International Holding Inc	N/C	N/C	N/C	N/C	N/C	N/C	N/C
14	Jubilant Oil & Gas Pte.Ltd	N/C	N/C	N/C	N/C	N/C	N/C	N/C
15	PTTEP South Asia Ltd	N/C	N/C	N/C	N/C	N/C	N/C	N/C
16	IsTech Energy EP5 Pte	N/C	N/C	N/C	N/C	N/C	N/C	N/C

N°	Company	N°	Name/Entity	Level of ownership	Nationality of the owner	Stock exchange quotations (yes/no)	Stock exchange	Owner (if the company's shares are not quoted)
17	Asia Orient International Ltd	N/C	N/C	N/C	N/C	N/C	N/C	N/C
18	CNPC International Ltd	1	CNPC International Ltd	100%	China	N/C	N/C	N/C
19	SNOG Pte Ltd	1	Gouvernement of Myanmar	15%	N/C	N/C	N/C	N/C
		2	SNOG Pte.Ltd	80%	N/C	N/C	N/C	N/C
		3	Singapore UPR Pte.Ltd. China	5%	N/C	N/C	N/C	N/C
20	Eni Myanmar BV	N/C	N/C	N/C	N/C	N/C	N/C	N/C
21	Central Asia Oil and Gas (CAOG) Pte. Ltd			Berlanga Int'l Pte Ltd	100%	Singapore	No	N/A
22	Pacific Hunt Energy Corporation	1	Pacific Hun Energy Corp	100%	Canada	No	N/A	N/C
23	Bashneft International B.V	N/C	N/C	N/C	N/C	N/C	N/C	N/C
24	Brunei National Petroleum Co	1	Ministry of Finance Inc	100%	N/C	No	N/A	N/C
25	Petrovietnam Exploration Production Corporation			N/C	N/C	N/C	N/C	N/C
26	Oil India Ltd	N/C	N/C	N/C	N/C	N/C	N/C	N/C
27	Ophir Myanmar Ltd	1	Ophir Energy Plc	100%	UK	Yes	London Stock Exchange	N/A
28	Barlanga Myanmar Pte. Ltd.	1	Berlanga Int'l Pte Ltd	100%	Singapore	No	N/A	N/C
29	Shell Myanmar Energy Pte.Ltd	1	Royal Dutch Shell plc	100%	Netherlands	Yes	Amsterdam, London, New York	N/A
30	BG Exploration & Production Myanmar Pte. Ltd.	1	Royal Dutch Shell plc	100%	Netherlands	Yes	Amsterdam, London, New York	N/A
31	Woodside Energy (Myanmar) Pte. Ltd.		Woodside Energy (Myanmar) Pte Ltd	100%	Singapore	no	N/A	N/A
			Woodside Energy Holdings Pty Ltd	100%	Australia	no	N/A	N/A
			Woodside Energy Ltd	100%	Australia	no	N/A	N/A
			Woodside Petroleum Ltd	100%	Australia	Yes	Australian Stock Exchange (ASX)	N/A
32	CFG Energy Pte.Ltd.	N/C	N/C	N/C	N/C	N/C	N/C	N/C
33	Reliance Industries Ltd	N/C	N/C	N/C	N/C	N/C	N/C	N/C
34	Statoil Myanmar Pte. Ltd.	N/C	N/C	N/C	N/C	N/C	N/C	N/C
35	Tap Energy Pte. Ltd.	N/C	N/C	N/C	N/C	N/C	N/C	N/C

Appendix 2.b. Oil and Gas transportation

N°	Company	N°	Name/Entity	Level of ownership	Nationality of the owner	Stock exchange quotations (yes/no)	Stock exchange	Owner (if the company's shares are not quoted)
1	Andaman Transportation Limited (ATL)		N/C	N/C	N/C	N/C	N/C	N/C
		1	TEPM	31.24%	French	Yes	Paris	N/A
2	Moattama Gas Transportation Company (MGTC)	2	UGVL	28.26%	American	Yes	America	N/A
		3	PTTEPI	25.50%	Thai	Yes	Thailand	N/A
		4	MOGE	15.00%	Myanmar	No	N/A	N/A
		1	PC Myanmar (Hong Kong) Limited	10.91%	Hong Kong	No	N/A	N/C
3	Taninthayi Pipeline Company (TPC)	2	Myanma Oil and Gas Enterprise	20.45%	Myanmar	No	N/A	N/C
		3	Nippon Oil Exploration (Myanmar)	19.32%	Japan	No	N/A	N/C
		4	PTTEP International Limited	19.32%	Thailand	No	N/A	N/C
		5	PETRONAS Carigali Myanmar III Inc	30.00%	Cayman Islands	No	N/A	N/C
4	South-East Asia Gas Pipeline Co (SEAGP)			N/C	N/C	N/C	N/C	N/C
5	South East Asia Crude Oil Pipeline Co, Ltd (SEACOP)		N/C	N/C	N/C	N/C	N/C	N/C

Appendix 2.c. Gems and Jade

No	Company	N°	Name/Entity	Level of ownership	Nationality of the owner	Stock exchange quotations (yes/no)	Stock exchange	Owner (if the company's shares are not quoted)
1	Myanmar Win Gate Gems & Jewellery Mining	1	U KYAW THIIHA	40%	MYANMAR	No	No	N/C
		2	DAW NWAY EI EI ZIN	20%	MYANMAR	No	No	N/C
		3	DAW THIRI SWE	20%	MYANMAR	No	No	N/C
		4	DAW NU NU SWE	20%	MYANMAR	No	No	N/C
2	Sein Lom Taung Tan Gems Ltd. (*)	1	U YAN CHIN SEIN	21%	MYANMAR	No	No	N/C
		2	DAW ZU HWAM	14%	MYANMAR	No	No	N/C
		3	DAW AYE KYU	7%	MYANMAR	No	No	N/C
		4	U LAN PIYN SITE	14%	MYANMAR	No	No	N/C
		5	U PYIN SHO	14%	MYANMAR	No	No	N/C
		6	U THEIN AUNG	1%	MYANMAR	No	No	N/C
		7	U KYAW SOE TUN	4%	MYANMAR	No	No	N/C
		8	DAW KHIN THET OO	4%	MYANMAR	No	No	N/C
		9	DAW THAN THAN SWE	21%	MYANMAR	No	No	N/C
3	Yar Za Htar Ne Gems Co;Ltd. (*)	1	U Zaw Bo Khant	94%	MYANMAR	No	No	N/C
		2	U Soe Win	6%	MYANMAR	No	No	N/C
4	Myanmar Imperial Jade(Gems & Jewellery) (*)	1	MYANMA ECONOMIC HOLDINGS LTD	100%	MYANMAR	No	No	N/C
5	Wai Aung Gabar Gems Co; Ltd. (*)	1	Daw Htet Hteet Wai	23%	Myanmar	No	No	N/C
		2	U Lee Kyone Yin @ U Myat Htwe	23%	Myanmar	No	No	N/C
		3	U Sai Yee	1%	Myanmar	No	No	N/C
		4	U Sai Shen Twee	23%	Myanmar	No	No	N/C
		5	Daw Let Let Wai	9%	Myanmar	No	No	N/C
		6	Daw Nway Nway Hlaing	9%	Myanmar	No	No	N/C
		7	Daw Yu Yu San	13%	Myanmar	No	No	N/C
6	Ayar Jade Co; Ltd.	1	ဦးလှိုင်နိုင်	90%	MYANMAR	No	No	N/C
		2	ဦးအောင်တန်	10%	MYANMAR	No	No	N/C
7	Myat Yamon Gems Co;Ltd. (*)	1	U Chit Sein	40%	Myanmar	No	No	N/C
		2	U Kyaw Oo	25%	Myanmar	No	No	N/C
		3	U Khin Maung Myint	25%	Myanmar	No	No	N/C
		4	U Tin Myint	10%	Myanmar	No	No	N/C
8	Kyauk Seinn Nagar (Gems) (*)	1	U Nay Win Swe @ U Nay Win Tun	80%	Myanmar	No	No	N/C
		2	Daw Aye Aye Myint	2%	Myanmar	No	No	N/C
		3	Daw Myint Myat Thu	4%	Myanmar	No	No	N/C
		4	U Ye Myat Thu	2%	Myanmar	No	No	N/C

No	Company	N°	Name/Entity	Level of ownership	Nationality of the owner	Stock exchange quotations (yes/no)	Stock exchange	Owner (if the company's shares are not quoted)
		5	U Min Myat Thu	2%	Myanmar	No	No	N/C
		6	U Khin Zaw	2%	Myanmar	No	No	N/C
		7	U Maung Maung Naing	2%	Myanmar	No	No	N/C
		8	U Zaw Weik	2%	Myanmar	No	No	N/C
		9	U Win Naing	2%	Myanmar	No	No	N/C
		10	U Zaw Lay Myint	2%	Myanmar	No	No	N/C
		11	U Nay Soe Kyaw	2%	Myanmar	No	No	N/C
9	Myanmar Sithu Jewellery (*)		U Wang Shan Lyan					
		1	@ U Khin Maung Soe	33%	Myanmar	No	No	N/C
		2	Daw San San Aye	50%	Myanmar	No	No	N/C
			U Chit Lwin Oo					
		3	@U Chit Oo Lwin	7%	Myanmar	No	No	N/C
		4	U SiThu	7%	Myanmar	No	No	N/C
		5	U Chit Khaing	3%	Myanmar	No	No	N/C
10	Linn Lett Win Yadanar Gems (*)	1	Dr. Tun Kyi	50%	Myanmar	No	No	N/C
		2	Daw Kyi Kyi Aye (a) Daw Ah Chin	50%	Myanmar	No	No	N/C
11	Yadanar Taung Tann Gems (*)	1	U Tun Myint Naing	24%	Myanmar	No	No	N/C
		2	U Than Myint	5%	Myanmar	No	No	N/C
		3	U Maung Kyay	5%	Myanmar	No	No	N/C
		4	U Khin Aung	2%	Myanmar	No	No	N/C
		5	U Thet Naing	2%	Myanmar	No	No	N/C
		6	U Myat Cho Win	2%	Myanmar	No	No	N/C
		7	Asia World Company	60%	Myanmar	No	No	N/C
12	Khin Zaw Aung & Brothers Gems & Jewellery (*)	1	U Khin Zaw Aung	7%	Myanmar	No	No	N/C
		2	U Than Tun Aung	3%	Myanmar	No	No	N/C
		3	Daw Chein Yu Yin	20%	Myanmar	No	No	N/C
		4	Daw Nan Lee	20%	Myanmar	No	No	N/C
		5	U Tin Win	10%	Myanmar	No	No	N/C
		6	Shi Shauk Kyi @ U Tin Pe	10%	Myanmar	No	No	N/C
		7	U Aung Aung @ U Aung Tu	30%	Myanmar	No	No	N/C
13	Shwe Gaung Gaung Gems	1	U Chit Lwin	54%	Myanmar	No	No	N/C
		2	U Than Htay(a)U Maung Maung	24%	Myanmar	No	No	N/C
		3	Daw Hmawe Hmawe	13%	Myanmar	No	No	N/C
		4	U Aung Thwin Lay	7%	Myanmar	No	No	N/C
		5	U Shay Reh	1%	Myanmar	No	No	N/C
		6	U Myint Aung	1%	Myanmar	No	No	N/C
14	Xie Family (*)	1	U Tin Maung	20%	Myanmar	No	No	N/C
		2	U Maung Gyi	20%	Myanmar	No	No	N/C
		3	Daw Myint	20%	Myanmar	No	No	N/C

No	Company	N°	Name/Entity	Level of ownership	Nationality of the owner	Stock exchange quotations (yes/no)	Stock exchange	Owner (if the company's shares are not quoted)
		4	Daw Shwe Cynn	20%	Myanmar	No	No	N/C
		5	Daw Law Kyein	12%	Myanmar	No	No	N/C
		6	U Kyaw Kyaw Tun	8%	Myanmar	No	No	N/C
15	Great Genesis Gems Co; Ltd. (*)	1	Daw Nang Saw Htwe	100%	Myanmar	No	No	N/C
16	Richest Gems Co;Ltd. (*)	1	U Win Tin (Chairman)	22%	Myanmar	No	No	N/C
		2	U Hla Htoo (Managing Director)	32%	Myanmar	No	No	N/C
		3	Daw Aye Nyein (Director)	9%	Myanmar	No	No	N/C
		4	U Kyaw Thu (Director)	19%	Myanmar	No	No	N/C
		5	Daw Hla Nu Htwe (Director)	9%	Myanmar	No	No	N/C
		6	Daw Ye Ye Myint (Director)	9%	Myanmar	No	No	N/C
17	Kyaing International Gems (*)	1	KYAING SAN SHWE	80%	Myanmar	No	No	N/C
		2	WIN TIN	20%	Myanmar	No	No	N/C
18	Phyo Thiha Kyaw Gems	1	DAW KHIN THAN KYI	95%	Myanmar	No	No	N/C
		2	U SEIN WIN	3%	Myanmar	No	No	N/C
		3	U KAUNG SI THU	2%	Myanmar	No	No	N/C
		4	U THEIN ZAW	0%	Myanmar	No	No	N/C
		5	U YONE SHWE	0%	Myanmar	No	No	N/C
		6	DAW YIN YIN	0%	Myanmar	No	No	N/C
19	Myanma Gon Yi Gems & Jewellery (Kaung Myat Thukha Company Limited)	1	N/C			No	No	N/C
20	Kyaw Naing & Brothers	1	U KYAW NAING	10%	Myanmar	No	No	N/C
		2	U WAM SEIN YINT	3%	Myanmar	No	No	N/C
		3	U SAING SINT	3%	Myanmar	No	No	N/C
		4	U SAING KYAW SHI	42%	Myanmar	No	No	N/C
		5	U SAING CHIN	42%	Myanmar	No	No	N/C
		6	U AUNG CHAN MIN	0%	Myanmar	No	No	N/C
21	Kyay Sin Phyu	1	Daw Waing Waing Myint	40%	Myanmar	No	No	N/C
		2	Daw Pyone Thandar	30%	Myanmar	No	No	N/C
		3	U Aung Aung	30%	Myanmar	No	No	N/C
22	HTOO JEWELLERY CO.,LTD.	1	U Tay Za	49%	Myanmar	No	No	N/C
		2	U Thiha	16%	Myanmar	No	No	N/C
		3	U Zaw Mynn@Chan Kwang Lu	16%	Myanmar	No	No	N/C
		4	U Thet Naing	2%	Myanmar	No	No	N/C
		5	U Htoo Htet Tay Za	16%	Myanmar	No	No	N/C
		6	U Tin Maung	2%	Myanmar	No	No	N/C
23	Ngwe Hein Htet Gems & Jewellery	1	U Win Naing	73%	Myanmar	No	No	N/C
		2	Daw Wai Wai Mon	24%	Myanmar	No	No	N/C

No	Company	N°	Name/Entity	Level of ownership	Nationality of the owner	Stock exchange quotations (yes/no)	Stock exchange	Owner (if the company's shares are not quoted)
		3	U Min Thein Kha	4%	Myanmar	No	No	N/C
24	Lyan Shan Jewellery Co; Ltd.	1	N/C		N/C			N/C
25	Yadanar Pyi Phyo Aung Gems And Jewellery Co; Ltd.	1	Daw Kyi Kyi Aye	33%	Myanmar	No	No	N/C
		2	Daw Wai Wai Htwe	67%	Myanmar	No	No	N/C
26	PAING PHYO THIIHA GEMS	1	U THIIHA OO	95%	Myanmar	No	No	N/C
		2	DAW KHIN MAY KYI @ MA YU	5%	Myanmar	No	No	N/C
27	EIGHTY THOUSAND GEMS & JEWELLERY Co;Ltd	N/C		N/C				N/C
28	Tun Naing Aung Gems	N/C		N/C				N/C
29	Thit Sar Pan (U Kyaw Min Naing) (private)	N/C		N/C				N/C
30	Chaow Brothers Gemstone	1	U Chaow Yin Htone	60%	Myanmar	No	No	N/C
		2	U Than Naing Win	35%	Myanmar	No	No	N/C
		3	U Zin Lin Tun	5%	Myanmar	No	No	N/C
31	Mann Ayer Family Co.,Ltd.					No	No	N/C
32	(1.1.1) Gems & Jewellery (*)	1	DAW TIN TIN SHWE	63%	Myanmar	No	No	N/C
		2	DAW KHAING KHAING OO	7%	Myanmar	No	No	N/C
		3	DAW HMWAY KHAYAY	1%	Myanmar	No	No	N/C
		4	U SHOUK HOUN	21%	Myanmar	No	No	N/C
		5	DAW WIN WIN KHAING	7%	Myanmar	No	No	N/C
33	Oo Ya Gems & Jewellery Co;Ltd.	1	U Jan Pin Chang	27%	Myanmar	No	No	N/C
		2	Daw Than Kyi	23%	Myanmar	No	No	N/C
		3	U Kyaw Sein	4%	Myanmar	No	No	N/C
		4	U Tin Win	2%	Myanmar	No	No	N/C
		5	U San Wai Chin	15%	Myanmar	No	No	N/C
		6	U Kyaw Wai @ San Wai Hwar	27%	Myanmar	No	No	N/C
		7	U Win Naing Oo	2%	Myanmar	No	No	N/C
34	Myanmar Economics Corporation	1	N/C	N/C	N/C	N/C	N/C	
35	Pang Huke Duwa Co; Ltd.	1	ဦးလှိုင်ဦး	29%	Myanmar	No	No	N/C
		2	ဦးအောင်တန်	22%	Myanmar	No	No	N/C
		3	ဦးဒုန်းစိန်	24%	Myanmar	No	No	N/C
		4	ဦးလှိုင်အောင်	5%	Myanmar	No	No	N/C
		5	ဦးအောင်အောင်	2%	Myanmar	No	No	N/C
		6	ဦးဘဝင်းအောင်	1%	Myanmar	No	No	N/C

No	Company	N°	Name/Entity	Level of ownership	Nationality of the owner	Stock exchange quotations (yes/no)	Stock exchange	Owner (if the company's shares are not quoted)
		7	ဦးမြင့်	1%	Myanmar	No	No	N/C
		8	ဦးအိမ်ငွေ	1%	Myanmar	No	No	N/C
		9	ဒေါ်နီနီ	1%	Myanmar	No	No	N/C
		10	ဦးသန့်ဇော်	14%	Myanmar	No	No	N/C
36	Khun Pa-Oh Gems & Jewellery	N/C		N/C				N/C
37	Kachin National Development	1	U Ma Htu Naw	13%	Myanmar	No	No	N/C
		2	U Lahpai Zaw	13%	Myanmar	No	No	N/C
		3	U Zaw Seng	13%	Myanmar	No	No	N/C
		4	U La Bang Gu Ra	22%	Myanmar	No	No	N/C
		5	U Da Ban Nodele	11%	Myanmar	No	No	N/C
		6	U Hla Tun @ U Hla Tung	8%	Myanmar	No	No	N/C
		7	U Kaung Kwe Pinn @ U Shwe Myint	8%	Myanmar	No	No	N/C
		8	U tu ja	8%	Myanmar	No	No	N/C
		9	U Gum Dan Du	0%	Myanmar	No	No	N/C
		10	U Tun Min	3%	Myanmar	No	No	N/C
38	Silver Elephant Gems	N/C		N/C		N/C	N/C	N/C
39	Myo Nwe Gems & Jewellery	1	U Khin Maung Myint	70%	Myanmar	No	No	N/C
		2	Daw Lily Myint	28%	Myanmar	No	No	N/C
		3	U Nay Aung	2%	Myanmar	No	No	N/C
40	Shining Star Light Gems & Jewellery (*)	1	Daw Nan Lin Lin Tun	98%	Myanmar	No	No	N/C
		2	U Aung Aung Myint	1%	Myanmar	No	No	N/C
		3	U Nyi Nyi	1%	Myanmar	No	No	N/C
		4	U Myint Ko	0%	Myanmar	No	No	N/C
41	Myanma Seinn Lei Aung Gems	1	U Si Thu Myat	0%	Myanmar	No	No	N/C
		2	U Thein Shwe	0%	Myanmar	No	No	N/C
		3	U Hla Win	74%	Myanmar	No	No	N/C
		4	D. Aye Thandar	26%	Myanmar	No	No	N/C
42	Myanmar Naing Group	N/C		N/C		N/C	N/C	N/C
43	Pho Thar Htoo Gems Co; Ltd.	1	U Than Aye	50%	Myanmar	No	No	N/C
		2	Daw Myint Myint Shwe	10%	Myanmar	No	No	N/C
		3	Dr Tun Kyi	10%	Myanmar	No	No	N/C
		4	Daw kyi Kyi Aye	10%	Myanmar	No	No	N/C
		5	U Shauk Fang	10%	Myanmar	No	No	N/C
		6	U Eike Ti	10%	Myanmar	No	No	N/C
44	RUBY DRAGON JADE & GEMS Co.,Ltd	1	U Nay Win Swe @ U Nay Win Tun	64%	Myanmar	No	No	N/C

No	Company	N°	Name/Entity	Level of ownership	Nationality of the owner	Stock exchange quotations (yes/no)	Stock exchange	Owner (if the company's shares are not quoted)
		2	U Ye Myat Thu	7%	Myanmar	No	No	N/C
		3	Daw Aye Aye Myint	1%	Myanmar	No	No	N/C
		4	Daw Myint Myat Thu	2%	Myanmar	No	No	N/C
		5	U Ye Myat Thu	2%	Myanmar	No	No	N/C
		6	U Maung Maung Naing	2%	Myanmar	No	No	N/C
		7	U Khin Maung Than	2%	Myanmar	No	No	N/C
		8	U Nay Soe Kyaw	2%	Myanmar	No	No	N/C
		9	U Zaw Weik	2%	Myanmar	No	No	N/C
		10	U Khin Zaw	2%	Myanmar	No	No	N/C
		11	U Win Naing	2%	Myanmar	No	No	N/C
		12	U Zaw Lay Myint	2%	Myanmar	No	No	N/C
		13	U Nanda Aung	2%	Myanmar	No	No	N/C
		14	U Khun Tun Kyaw	2%	Myanmar	No	No	N/C
		15	U Tun Win	2%	Myanmar	No	No	N/C
		16	U Ye Min Htut	2%	Myanmar	No	No	N/C
		17	U Myint Thein	2%	Myanmar	No	No	N/C
		18	U Soe Than	2%	Myanmar	No	No	N/C
		19	U Sain San Tit	2%	Myanmar	No	No	N/C
		20	Daw Khin Mya Mya Tun	0%	Myanmar	No	No	N/C
		21	U Ye Min	0%	Myanmar	No	No	N/C
45	Thi Raw Mani Gems & Jewellery (*)	1	U HTUN THEIN@ U TUN TUN	56%	Myanmar	No	No	N/C
		2	DAW WAI WAI	18%	Myanmar	No	No	N/C
		3	U TUN SEIN	0%	Myanmar	No	No	N/C
		4	U ZAW TUN NAING	6%	Myanmar	No	No	N/C
		5	U ZAW TUN WAI	6%	Myanmar	No	No	N/C
		6	U ZAW TUN AUNG	6%	Myanmar	No	No	N/C
		7	DAW THAZIN HTUN	6%	Myanmar	No	No	N/C
46	Kan Par Ni Gems & Jewellery Co.,Ltd.	1	Daw Chein Yu Shin	20%	Myanmar	No	No	N/C
		2	U Sai Si Thu	0%	Myanmar	No	No	N/C
		3	U Kyaw Htet Aung	50%	Myanmar	No	No	N/C
		4	U Kyaw Htet Khaing @ Colin	30%	Myanmar	No	No	N/C
47	Golden Grate Wall Gems Co., Ltd	1	Daw Nan Lin Lin Tun	98%	Myanmar	No	No	N/C
		2	U Kyaw Min Latt	2%	Myanmar	No	No	N/C
48	Kyauk Gyi Gone Gems & Jewellery Co., Ltd	1	U Tin Win	30%	Myanmar	No	No	N/C
		2	U Kyaw Htet Aung	30%	Myanmar	No	No	N/C
		3	U Kyaw Htet Khaing @ Colin	40%	Myanmar	No	No	N/C
49	Phar Kant Yar Zar Gems &	1	U Zaw Min Kyaw	10%	Myanmar	No	No	N/C

No	Company	N°	Name/Entity	Level of ownership	Nationality of the owner	Stock exchange quotations (yes/no)	Stock exchange	Owner (if the company's shares are not quoted)
	Jewellery Co.,Ltd	2	Daw Chein Yu Shin	10%	Myanmar	No	No	N/C
		3	U Kyaw Htet Aung	50%	Myanmar	No	No	N/C
		4	U Kyaw Htet Khaing @ Colin	30%	Myanmar	No	No	N/C
50	Zwe Htet Lwin Gems & Jewellery Co.,Ltd	1	U Tin Win	20%	Myanmar	No	No	N/C
		2	U Kyaw Htet Aung	40%	Myanmar	No	No	N/C
		3	U Kyaw Htet Khaing @ Colin	40%	Myanmar	No	No	N/C
51	Lin Yaung Phyar Gems Co.,Ltd	1	U Tun Tun Naing	10%	Myanmar	No	No	N/C
		2	U Tin Win	10%	Myanmar	No	No	N/C
		3	U Kyaw Htet Aung	40%	Myanmar	No	No	N/C
		4	U Kyaw Htet Khaing @ Colin	40%	Myanmar	No	No	N/C
52	Kaung Wai Yan Gems Co.,Ltd	1	Daw Li Kwai Shan	25%	Myanmar	No	No	N/C
		2	U Chein Soak	25%	Myanmar	No	No	N/C
		3	U Myint Zaw Hein	0%	Myanmar	No	No	N/C
		4	U Lwai Khine Wan	25%	Myanmar	No	No	N/C
		5	Daw Myint Kyi	25%	Myanmar	No	No	N/C
53	Yadanar San Shwin Gems Co., Ltd	1	San Hlaing	79%	Myanmar	No	No	N/C
		2	Yi Yi Cho	2%	Myanmar	No	No	N/C
		3	Phone yu Kyauk @ Aye Aye	19%	Myanmar	No	No	N/C
54	SHWE BYAIN PHYU CO	N/C						N/C
55	NILAR YOMA TRADING	1	U Aung Ko Win	42%	Myanmar	No	No	N/C
		2	Daw Nan Than Htwe	33%	Myanmar	No	No	N/C
		3	Daw Nang Lang Kham	25%	Myanmar	No	No	N/C
56	Jade Mountain Gems Co.;Ltd. (*)	1	U SEIN WIN	62%	Myanmar	No	No	N/C
		2	Daw KHIN THAN KYI	37%	Myanmar	No	No	N/C
		3	U KYAW WIN	1%	Myanmar	No	No	N/C
		4	U TIN SHWE	1%	Myanmar	No	No	N/C
57	Ever Winner Gems (*)	1	U AIKE HTWE	40%	Myanmar	No	No	N/C
		2	DAW KYAUK CHI PHONE	30%	Myanmar	No	No	N/C
		3	DAW WAI WAI HTWE	30%	Myanmar	No	No	N/C
58	Than Lwin Aye Yar Gems Co., Ltd. (Kaung Myat Thu Kha Co. Ltd)	1	U Tun Kyi	11%	Myanmar	No	No	N/C
		2	U Hla Myint	11%	Myanmar	No	No	N/C
		3	U Saw Lin	11%	Myanmar	No	No	N/C
		4	Daw Wai Wai Htwe	33%	Myanmar	No	No	N/C
		5	Daw Kyi Kyi Htwe	33%	Myanmar	No	No	N/C
59	Jade Padathar Gems + Shwe	1	Tun Kyaw	2%	Myanmar	No	No	N/C

No	Company	N°	Name/Entity	Level of ownership	Nationality of the owner	Stock exchange quotations (yes/no)	Stock exchange	Owner (if the company's shares are not quoted)
	Gaung Gaung Gems	2	San Hlaing	65%	Myanmar	No	No	N/C
		3	Tun Kyaw Win	2%	Myanmar	No	No	N/C
		4	Phone Yuu Kyauk @ Aye Aye	31%	Myanmar	No	No	N/C
60	Khine Myanmar Gems Co.;Ltd.	1	U Aung Kyaw Myint (Managing Director)	23%	Myanmar	No	No	N/C
		2	U Saw Lin (Director)	41%	Myanmar	No	No	N/C
		3	Daw San San Toe (Director)	35%	Myanmar	No	No	N/C
		4	Daw Shaw Feng (Director)	1%	Myanmar	No	No	N/C
61	Kan Pwint Oo	1	U SHOUK SHAN	50%	Myanmar	No	No	N/C
		2	DAW MYA SEIN	10%	Myanmar	No	No	N/C
		3	U MIN LWIN	19%	Myanmar	No	No	N/C
		4	U CHIT HTWE	10%	Myanmar	No	No	N/C
		5	DAW WIN WIN KHAING	0%	Myanmar	No	No	N/C
		6	DAW KHIN WIN KYI	2%	Myanmar	No	No	N/C
		7	DAW KHIN KHIN HTWE	2%	Myanmar	No	No	N/C
		8	DAW HMWAY KHAYAY	0%	Myanmar	No	No	N/C
		9	U SHOUK HOUN	4%	Myanmar	No	No	N/C
		10	DAW TIN TIN SHWE	2%	Myanmar	No	No	N/C
		11	DAW KHAING KHAING OO	2%	Myanmar	No	No	N/C
62	KHA YANN MYAY GEMS	1	U Tun Kyaw	40%	Myanmar	No	No	N/C
		2	Daw Mie Nge	40%	Myanmar	No	No	N/C
		3	Daw Thandar Oo	20%	Myanmar	No	No	N/C
63	Kyay Lin	1	U MAUNG LAY	50%	Myanmar	No	No	N/C
		2	U AHEIK KWYE	10%	Myanmar	No	No	N/C
		3	U AHEIK TUN	10%	Myanmar	No	No	N/C
		4	DAW LA HTAW LU @ DAW YIN YIN	10%	Myanmar	No	No	N/C
		5	DAW NILAR AUNG	10%	Myanmar	No	No	N/C
		6	U SAN AUNG	10%	Myanmar	No	No	N/C
64	Kyaw Thet Aung	1	U Htin Paw	20%	Myanmar	No	No	N/C
		2	Daw Moe Moe Sein	20%	Myanmar	No	No	N/C
		3	U Kyin Sein	20%	Myanmar	No	No	N/C
		4	Daw Kywe kywe Sein	20%	Myanmar	No	No	N/C
		5	Daw Yin Yin	20%	Myanmar	No	No	N/C
65	Aung Hein Min Gems Co.,Ltd	1	U Chit San	43%	Myanmar	No	No	N/C
		2	Daw Yin Yin Lae	28%	Myanmar	No	No	N/C
		3	U Than Naing Win	15%	Myanmar	No	No	N/C
		4	U Zaw Naing Oo	15%	Myanmar	No	No	N/C

No	Company	N°	Name/Entity	Level of ownership	Nationality of the owner	Stock exchange quotations (yes/no)	Stock exchange	Owner (if the company's shares are not quoted)
66	YadanarYaungChi Gems Co.,Ltd	N/C						N/C
67	Yadanar Kaung Kin Gems & Jewellery Co.; Ltd	1	U Kyaw Tun Naing	100%	Myanmar	No	No	N/C
		2	U Sai Wan Hlaing	0%	Myanmar	No	No	N/C
		3	Daw Yee Yee	0%	Myanmar	No	No	N/C
68	Big Jade Gems Co.,Ltd.	1	N/C	N/C	N/C	N/C	N/C	
69	Golden Wallet Jewellery Co.,Ltd	1	U Sai Myo Myint	98%	Myanmar	No	No	N/C
		2	U Myint Ko	1%	Myanmar	No	No	N/C
		3	U La Mai	1%	Myanmar	No	No	N/C
70	Tun Tauk Sa Gems Co.,Ltd.	1	N/C	N/C	N/C	N/C	N/C	

Appendix 2.c. Other minerals

No.	Company	N°	Name/Entity	Level of ownership	Nationality of the owner	Stock exchange quotations (yes/no)	Stock exchange	Owner (if the company's shares are not quoted)
1	Myanmar CNMC Nickel Co; LTD (*)	1	CNMC Nickel Co., Ltd.	100%	China	Yes	N/C	N/C
2	Myanma Economic Corporation		N/C	N/C	N/C	N/C	N/C	N/C
3	Ruby Dragon Mining Co., Ltd.	1	U Nay Win Tun (a) U Nay Win Swe	64.46%	Myanmar	No	No	N/C
		2	U Ye Myat Thu	5.80%	Myanmar	No	No	N/C
		3	Daw Aye Aye Myint	1.74%	Myanmar	No	No	N/C
		4	Daw Myint Myat Thu	1.74%	Myanmar	No	No	N/C
		5	U Min Myat Thu	1.74%	Myanmar	No	No	N/C
		6	U Khin Zaw	1.62%	Myanmar	No	No	N/C
		7	U Maung Maung Naing	1.74%	Myanmar	No	No	N/C
		8	U Zaw Weik	1.63%	Myanmar	No	No	N/C
		9	U Win Naing	1.63%	Myanmar	No	No	N/C
		10	U Zaw Lay Myint	1.63%	Myanmar	No	No	N/C
		11	U Nay Soe Kyaw	1.63%	Myanmar	No	No	N/C
		12	U Wunna Aung	0.11%	Myanmar	No	No	N/C
		13	U Myint Thein	1.63%	Myanmar	No	No	N/C
		14	U Khun Tun Kyaw	1.63%	Myanmar	No	No	N/C

No.	Company	N°	Name/Entity	Level of ownership	Nationality of the owner	Stock exchange quotations (yes/no)	Stock exchange	Owner (if the company's shares are not quoted)
		15	U Sai San Tit	1.63%	Myanmar	No	No	N/C
		16	U Khin Maung Than	1.63%	Myanmar	No	No	N/C
		17	U Ye Min Htut	1.63%	Myanmar	No	No	N/C
		18	U Tun Win	1.63%	Myanmar	No	No	N/C
		19	U Tun Aung	1.16%	Myanmar	No	No	N/C
		20	U Min Thein Htike	0.11%	Myanmar	No	No	N/C
		21	U Sai Tin Tun Aung	1.16%	Myanmar	No	No	N/C
		22	U Tun Win	1.16%	Myanmar	No	No	N/C
		23	Daw Khin Myat MyatTun	1.16%	Myanmar	No	No	N/C
4	Shwe Taung Mining Co., Ltd.	1	Shwe Taung Development Co.,Ltd	0.88	Myanmar	No	No	N/C
		2	U Aung Zaw Naing	0.08	Myanmar	No	No	N/C
		3	U Chan Mya	0.04	Myanmar	No	No	N/C
5	NgweYi Palae Mining Co.,Ltd (*)	1	U Thein Myint @ Kyaung Hpin	43.55%	Chinese	No	No	N/C
		2	U Myint Shein	29.20%	Chinese	No	No	N/C
		3	U Kyaw Shein	6.81%	Chinese	No	No	N/C
		4	U Tun Win	6.81%	Chinese	No	No	N/C
		5	Ushin Si @ U Hla Win	4.87%	Chinese	No	No	N/C
		6	U Shwe @ Khin Maung Swe	4.87%	Chinese	No	No	N/C
		7	U Sein Myo Aung	1.95%	Burmese	No	No	N/C
		8	Daw Khin Khin Myint	1.95%	Chinese	No	No	N/C
6	Win Myint Mo Industries Co.,Ltd (*)	1	U Maung Kyay	15%	Myanmar	No	No	N/C
		2	U Than Myint	23%	Myanmar	No	No	N/C
		3	U Ye Htut	2%	Myanmar	No	No	N/C
		4	U Naylin	2%	Myanmar	No	No	N/C
		5	Daw Aye	2%	Myanmar	No	No	N/C
		6	U Kyaw Thar	3%	Myanmar	No	No	N/C
		7	U Kyaw Myint	3%	Myanmar	No	No	N/C
		8	NHC	51%	Myanmar	No	No	N/C
7	Tha Byu Mining Co.,Ltd (*)	1	Dr.Tun Min Latt	83.33%	Myanmar	No	No	N/C

No.	Company	N°	Name/Entity	Level of ownership	Nationality of the owner	Stock exchange quotations (yes/no)	Stock exchange	Owner (if the company's shares are not quoted)
		2	Dr. Win Min Soe	16.50%	Myanmar	No	No	N/C
		3	U Win Maung	0.17%	Myanmar	No	No	N/C
8	GPS Joint Venture Co., Ltd. (*)		Mr.Luo Rong	98%	China	No	No	N/C
			Daw Lee Hunyinn	2%	Myanmar	No	No	N/C
9	Electrum Mining Co; Ltd		N/C	N/C	N/C	N/C	N/C	N/C
		1	Max (Myanmar) Co. Ltd	80%	Myanmar	No	NA	N/C
		2	M.Y Associate Co.,Ltd	10%	Myanmar	No	NA	N/C
10	Max Myanmar Industry Co;.,Ltd (*)	3	U Zaw Zaw (a) U Pho Zaw	10%	Myanmar	No	NA	N/C
		4	U Soe Tint	0%	Myanmar	No	NA	N/C
		5	U Ohn Kyaw (a) U Aye Twin	0%	Myanmar	No	NA	N/C
		6	Daw Htay Htay Khine	0%	Myanmar	No	NA	N/C
11	Htoo International Industrial Gorup Co.,Ltd	N/C	N/C	N/C	N/C	N/C	N/C	N/C
12	Tun Thwin Mining Co., Ltd	N/C	N/C	N/C	N/C	N/C	N/C	N/C
13		1	U Kyaw Aung	47%	Myanmar	No	No	N/C
	Shwe Moe Yan Co.,Ltd	2	U Kyaw Sein	35%	Myanmar	No	No	N/C
		3	U KYAW WIN LWIN	17%	Myanmar	No	No	N/C
		4	Daw Myint Myint Aye	0%	Myanmar	No	No	N/C
		5	U San Win OO	0%	Myanmar	No	No	N/C
14	Myanmar Yang Tse Copper Limited	Yang Tse Mining Ltd.		100%	Hong Kong	No	No	N/C
15	Sea Sun Star	N/C	N/C	N/C	N/C	N/C	N/C	N/C
		1	U Khine Lin	40%	No	No	No	N/C
16	Eastern Mining Co., Ltd	2	Daw Jan Yon Lee @ Daw Khin Shwe	40%	No	No	No	N/C
		3	U Kyaw Htoo Lin	20%	No	No	No	N/C
17	Swan Yadanar Htay Mining Co;Ltd	N/C	N/C	N/C	N/C	N/C	N/C	N/C
18	Swan Min Htet Mining Co;Ltd	N/C	N/C	N/C	N/C	N/C	N/C	N/C
		1	Daw Nan Yin	40%	Myanmar	No		N/C
19	Aung Brother Mining Co;Ltd	2	U Sai Than Aung	20%	Myanmar	No		N/C
		3	U Kaw Taung	20%	Myanmar	No		N/C

No.	Company	N°	Name/Entity	Level of ownership	Nationality of the owner	Stock exchange quotations (yes/no)	Stock exchange	Owner (if the company's shares are not quoted)
20	Eternal Mining Co., Ltd (*)	4	U Aung Kyaw	20%	Myanmar	No		N/C
		1	U Maung Ko	34%	Myanmar	No		N/C
		2	U Sai Maung Aye	17%	Myanmar	No		N/C
		3	U Aik Shan	33%	Myanmar	No		N/C
		4	U Maung Maung Latt	16%	Myanmar	No		N/C
21	National Prosperity Gold Production Group Ltd.	1	U Soe Htun Shein	N/C	N/C	N/C	N/C	N/C
		2	U Thiha Zaw Lynn	N/C	N/C	N/C	N/C	N/C
		3	Daw Nandy Lynn	N/C	N/C	N/C	N/C	N/C
		4	U Khaing Zaw Lynn	N/C	N/C	N/C	N/C	N/C
		5	Daw Nan Tit Phoung	N/C	N/C	N/C	N/C	N/C
		6	U Aung Moe	N/C	N/C	N/C	N/C	N/C
		7	U Kyaw Min Naing	N/C	N/C	N/C	N/C	N/C
1	U MYINT OO	15%	Myanmar	No	N/C			
22		2	U AUNG KYAW SINT	10%	Myanmar	No		N/C
		3	U THAN HTEIK AUNG	15%	Myanmar	No		N/C
		4	U THEIN OO	10%	Myanmar	No		N/C
		5	U BO BO KYAW	10%	Myanmar	No		N/C
		6	U WIN NAING TUN	40%	Myanmar	No		N/C
23	Myanmar Golden Point Family Co., Ltd.	1	U Khin Maung Myint	0%	Myanmar	NO		N/C
		2	Daw Shwe Ou	28%	Myanmar	NO		N/C
		3	U Kyaw Shwe	14%	Myanmar	NO		N/C
		4	U Kyaw Ngwe	14%	Myanmar	NO		N/C
		5	Daw Theint Theint Swe	28%	Myanmar	NO		N/C
		6	U Maung Maung Latt	14%	Myanmar	NO		N/C
		7	U Kyaw Nyunt	0%	Myanmar	NO		N/C
24	THAN TAW MYAT CO,LTD	1	U Sai Myo Thant	5%	Shan	No		N/C
		2	U Tun Tun Oo	84%	Chinese	No		N/C
		3	U Kyaw Oo	5%	Chinese	No		N/C
		4	U Toe Lone	5%	Myanmar	No		N/C
25	BAGAN BUSINESS GROUP	N/C	N/C	N/C	N/C	N/C	N/C	

No.	Company	N°	Name/Entity	Level of ownership	Nationality of the owner	Stock exchange quotations (yes/no)	Stock exchange	Owner (if the company's shares are not quoted)
26	Delco Co.,Ltd (*)	1	U Ding Ying	70%	Myanmar	No		N/C
		2	U Ying Bawm	20%	Myanmar	No		N/C
		3	Daw Hkaw Win	10%	Myanmar	No		N/C
27	Myanmar Pongpipat Co.,L td (*)	1	Mr. Sompong Chaltanpipt	5%	Thailand	No		N/C
		2	Mr. Kriangkrai Chavaltanpipat	5%	Thailand	No		N/C
		3	Ms. Sirima Chavaltanpipat	25%	Thailand	No		N/C
		4	Ms. Parichat Kotepetch	50%	Thailand	No		N/C
		5	Ms. Sirion Chavaltanpipat	15%	Thailand	No		N/C
28	1 UMEHL	100%	N/C	N/C	N/C			
29	Ye Htut Kyaw Mining Co.,Ltd	1	YHKM	100%	N/C	No	NA	N/C

Appendix 3: Adjustments to Oil & Gas Sub-sector

Appendix 3.1. Extractive company adjustments

The adjustments were carried out on the basis of confirmations from extractive companies and Government Agencies and were supported by adequate evidence wherever deemed appropriate. The adjustments made are detailed as follows:

Adjustments to extractive company payments	Total Amount (in MMK)
Tax reported but not paid	(45,594,757,053)
Tax paid reported but outside the period covered	(8,093,445,430)
Tax paid not reported	7,777,689,452
Tax amount incorrectly reported	4,631,522,728
Tax paid reported but outside the reconciliation scope	(919,730,871)
Total added to amounts originally reported	(42,198,721,174)

(a) Tax reported but not paid

Companies reported payments amounting to MMK 45,594,757,053 related to Income Tax and Training Fund. However, during the reconciliation work they stated that this payment was not made. Accordingly, we adjusted their reporting template. We set out in the table below a summary of the adjustments made by company

Adjustments to Oil & Gas Companies	Total Amount (in MMK)	Income Tax (IT)	Training Fund
Petronas Carigali Hong Kong Ltd (PCML)	(45,345,942,012)	(45,246,415,996)	(99,526,016)
Daewoo International Corporation	(149,289,024)	-	(149,289,024)
TOTAL	(99,526,016)	-	(99,526,016)
Total Training Funds adjusted	(45,594,757,053)	(45,246,415,996)	(348,341,057)

(b) Taxes paid reported but outside the period covered by the EITI Report

These are payments reported, but which fall outside the reconciliation period, i.e. before 1 April 2014 or after 31 March 2015. The amount adjusted was related to Royalties final payment made by Petronas Carigali Hong Kong Ltd (PCML). According to the company confirmation, the amount reported was adjusted.

(c) Tax paid not reported

Corresponds mainly to payments of 2014-2015 amounting to MMK 7,777,689,452 made by companies and not reported in their reporting templates. The amount was confirmed with the companies before adjustment. The detail by tax and by company is set out in the table below:

Company	Royalties	Production Bonus
Petronas Carigali Hong Kong Ltd (PCML)	6,758,889,452	-
PTTEP International Ltd.	-	1,018,800,000
Total	6,758,889,452	1,018,800,000

(d) Tax amount incorrectly reported

These adjustments correspond to tax payments incorrectly reported by companies. Accordingly, we corrected their reporting and added the payments made by them. We set out in the table below a summary of the adjustments made by tax:

Adjustments to extractive company payments	Total Amount (in MMK)	MOGE share (Profit and Cost-G&O sales)	Production Split (State share-Gas&Oil sales)	Royalties
Daewoo International Corporation	49,446,924,958	127,449,283,212	(92,551,488,245)	14,549,129,991
PTTEP International Ltd.	(44,815,402,230)	(16,061,791,808)	(17,847,353,484)	(10,906,256,938)
Total added to amounts originally reported	4,631,522,728	111,387,491,404	(110,398,841,730)	3,642,873,053

(e) Taxes reported but outside the reconciliation scope

Corresponds mainly to "Other material payments (> 50,000 USD)" amounting to MMK 919,730,871 reported by "Total".

Appendix 3.2. Adjustments to Government Entity templates

The adjustments were carried out on the basis of confirmations received from extractive companies or from Government Agencies and supported by payment receipts wherever deemed appropriate. These adjustments are detailed as follows:

Adjustments to Government Entity payments Total Amount (in MMK)	
Tax amount incorrectly reported	582,684,542,079
Tax received not confirmed	43,539,052,294
Tax reported but not received	(920,995,418)
Total added to amounts originally reported	625,302,598,954

(a) Tax amount incorrectly reported

These adjustments correspond to tax payments incorrectly reported by the Government Agencies. Accordingly, we corrected their reporting and added the payments made by them. We set out in the table below a summary of the adjustments made by tax:

Adjustments to extractive company payments	Total Amount (in MMK)	Production Split (State share-Gas&Oil sales)	MOGE share (Profit and Cost- G&O sales)	Royalties	Income Tax (IT)
TOTAL	397,098,713,527	397,098,713,527	-	-	-
PTTEP International Ltd.	139,838,601,645	55,425,183,657	50,306,827,019	34,106,590,970	-
Daewoo International Corporation	49,446,924,958	49,446,924,958	-	-	-
Petronas Carigali Hong Kong	(3,699,698,052)	-	-	-	(3,699,698,052)
Total added to amounts originally reported	582,684,542,079	501,970,822,142	50,306,827,019	34,106,590,970	(3,699,698,052)

(b) Taxes received not confirmed

These are payment flows reported by extractive companies, but which were not reported by Government Agencies. We set out in the table below a summary of the adjustments made to Government Agencies' initial reporting:

Adjustments to extractive company payments	Total Amount (in MMK)	Income Tax (IT)	Withholding tax	Stamp Duties	Commercial Tax on Imports	Customs Duties on imports
PTTEP International Ltd.	43,481,857,987	29,460,873,972	13,924,284,016	96,700,000	-	-
TOTAL	57,194,306	-	-	-	55,271,995	1,922,312
Total added to amounts originally reported	43,539,052,294	29,460,873,972	13,924,284,016	96,700,000	55,271,995	1,922,312

The adjustment related to the withholding tax PTTEPI is explained by the fact that this withholding is paid by PTTEPI as tax agent on behalf of its suppliers and sub-contractors. IRD did not maintain in its record the identity of the company that paid this withholding tax and can not therefore confirm that this amount was paid by PTTEPI. The payment receipt (challan) mention only the name of the supplier or sub-contractor and do not include the name of the company that withheld and paid the tax to IRD.

Therefore, the copies of the receipts were obtained from PTTEPI and communicated to IRD for confirmation. We note that IRD confirmed that the amounts were received during 2014-2015 but can not confirm that there were paid by PTTEPI.

(c) Taxes reported but not received

Corresponds mainly to Withholding tax amounting MMK 72,899,496 declared received from PTTEP International Ltd.

Appendix 4: Adjustments to Gems & Jade Sub-sector

Appendix 4.1. Extractive company adjustments

The adjustments were carried out on the basis of confirmations from extractive companies and Government Agencies and were supported by adequate evidence wherever deemed appropriate. The adjustments made are detailed as follows:

Adjustments to Gems & Jade Companies	Total Amount (in MMK)
Tax paid not reported	4,749,741,926
Tax reported but not paid	(1,915,602,706)
Tax paid reported but outside the reconciliation scope	(25,241,954)
Total adjustments	2,808,897,267

(a) Taxes paid not reported

These are payment flows reported by Government Agencies but were not reported by Gems and Jade companies. Adjustments were based on the receipt or confirmation of the company. We set out in the table below a summary of the adjustments made to company payments:

Adjustments to extractive company payments	Total Amount (in MMK)	Permit fees	Sale Split - 40%	Emporium Fees / Sale Fees	Commercial Tax	Other significant payments (> 50,000 USD) MGE	Other Taxes
Linn Lett Win Yadanar Gems	799,161,440	433,960,000	274,769,047	-	90,303,668	-	128,725
Kyaw Thet Aung	550,000,000	550,000,000	-	-	-	-	-
Kyaing International Gems	533,346,581	-	442,757,096	-	-	56,357,235	34,232,250
PAING PHYO THIHA GEMS	436,000,000	436,000,000	-	-	-	-	-
Myanmar Sithu Jewellery	397,607,387	-	-	116,438,528	-	281,168,859	-
Lyan Shan Jewellery Co; Ltd.	347,189,527	-	308,214,034	33,384,367	-	-	5,591,126
Aung Hein Min Gems Co.,Ltd	281,656,023	-	-	-	178,150,928	-	103,505,095
-38350001	274,558,888	-	184,128,848	-	-	-	90,430,040
Khine Myanmar Gems Co;Ltd.	179,383,165	-	-	-	129,206,056	-	50,177,109
Kyaw Naing & Brothers	178,183,754	73,320,000	-	104,863,754	-	-	-
Ever Winner Gems	174,326,084	119,000,000	-	22,219,434	19,920,000	-	13,186,650
Ngwe Hein Htet Gems & Jewellery	141,117,547	-	25,299,906	109,300,331	-	-	6,517,310
Lin Yaung Phyar Gems Co.,Ltd	115,434,334	-	-	61,076,756	-	-	54,357,578
Other Companies	341,777,196	92,450,000	121,107,390	82,516,714	-	-	45,703,092
Total added to amounts originally reported	4,749,741,926	1,704,730,000	1,356,276,321	529,799,885	417,580,652	337,526,095	403,828,974

(b) Tax reported but not paid

These adjustments were made to the Gems & Jade reporting templates. During the reconciliation work they stated that this payment was not made. Accordingly, we adjusted their reporting template.

Adjustments to extractive company payments	Total Amount (in MMK)	Sale Split - 40%	Royalties on Sales- 7%	Service Fees - 3%, 1%	Permit fees
Lyan Shan Jewellery Co; Ltd.	(849,022,114)	(849,022,114)	-	-	-
Shwe Gaung Gaung Gems	(807,117,648)	-	(564,982,102)	(242,135,547)	-
Ngwe Hein Htet Gems & Jewellery	(145,462,007)	-	-	(107,112,006)	(38,350,001)
Other Companies	(114,000,936)	(90,979,704)	-	(23,021,232)	-
Total added to amounts originally reported	(1,915,602,706)	(940,001,818)	(564,982,102)	(372,268,785)	(38,350,001)

(c) Tax paid reported but outside the period covered by the EITI Report

These are payments reported, but which fall outside the reconciliation period, i.e. before 1 April 2014 or after 31 March 2015. Adjustments were made to the reporting template of "Shwe Gaung Gaung Gems" for the "Other significant payments (> 50,000 USD) MGE »

Appendix 4.2. Adjustments to Government Agencies templates

The adjustments were carried out on the basis of confirmations received from extractive companies or from Government Agencies and supported by payment receipts wherever deemed appropriate. These adjustments are detailed as follows:

Adjustments to Government Entity payments	Total Amount (in MMK)
Tax reported but not received	(28,496,768,918)
Tax received on other identification number	(4,096,337,538)
Tax received not reported	866,354,159
Total added to amounts originally reported	(31,726,752,297)

(a) Taxes reported but not received

These adjustments were made to the Government Entity reporting templates. During the reconciliation work they stated that this payment was not received. Accordingly, we adjusted their reporting template. We set out in the table below a summary of the adjustments made to Government Agencies' initial reporting:

Adjustments to Government Entity payments	Total Amount (in MMK)	Royalties on Sales (IRD)	Commercial Tax (IRD)	Income Tax (IT)	Royalties on Sales- 7% (MGE)	Other Taxes
Myanmar Win Gate Gems & Jewellery Mining	(4,368,922,883)	(4,368,922,883)	-	-	-	-
Sein Lom Taung Tan Gems Ltd.	(2,141,419,769)	-	(2,141,419,769)	-	-	-
Linn Lett Win Yadanar Gems	(1,347,959,282)	-	(345,640,824)	(946,110,321)	-	(56,208,137)
Shwe Gaung Gaung Gems	(1,172,936,170)	(1,172,936,170)	-	-	-	-
Wai Aung Gabar Gems Co; Ltd.	(1,109,533,541)	(1,109,533,541)	-	-	-	-
Kyauk Seinn Nagar (Gems)	(1,096,442,411)	-	(1,096,442,411)	-	-	-
Myat Yamon Gems Co;Ltd.	(1,059,697,186)	-	(1,059,697,186)	-	-	-
Ever Winner Gems	(981,515,915)	-	(714,474,790)	-	(171,494,359)	(95,546,767)
Myanmar Sithu Jewellery	(862,168,440)	(862,168,440)	-	-	-	-
Ngwe Hein Htet Gems & Jewellery	(850,116,906)	-	(850,116,906)	-	-	-
Yadanar Pyi Phyo Aung Gems And Jewellery Co; Ltd.	(841,665,551)	-	-	(841,665,551)	-	-
PAING PHYO THIIHA GEMS	(784,874,090)	-	(784,874,090)	-	-	-
Shining Star Light Gems & Jewellery	(744,100,952)	-	(744,100,952)	-	-	-
Khin Zaw Aung & Brothers Gems & Jewellery	(700,946,735)	(700,946,735)	-	-	-	-
Mann Ayer Family Co.,Ltd.	(688,131,744)	-	(688,131,744)	-	-	-
Yadanar Taung Tann Gems	(633,746,143)	(633,746,143)	-	-	-	-
Jade Padathar Gems + Shwe Gaung Gaung Gems	(611,251,878)	(611,251,878)	-	-	-	-

Adjustments to Government Entity payments	Total Amount (in MMK)	Royalties on Sales (IRD)	Commercial Tax (IRD)	Income Tax (IT)	Royalties on Sales- 7% (MGE)	Other Taxes
HTOO JEWELLERY CO.,LTD.	(542,134,578)	-	(542,134,578)	-	-	-
KHA YANN MYAY GEMS	(510,609,099)	(510,609,099)	-	-	-	-
Richest Gems Co;Ltd.	(450,707,420)	(450,707,420)	-	-	-	-
Great Genesis Gems Co; Ltd.	(433,633,486)	-	(433,633,486)	-	-	-
Kyaw Naing & Brothers	(508,725,670)	-	-	-	(391,339,172)	(117,386,498)
Other Companies	(6,055,529,068)	(6,002,777,883)	-	-	-	(52,751,185)
Total added to amounts originally reported	(28,496,768,918)	(16,423,600,192)	(9,400,666,736)	(1,787,775,872)	(562,833,531)	(321,892,587)

(b) Taxes received on other identification number

These are payment flows reported by Government Entity, but which were not reported by Gems & Jade companies. During the reconciliation work we stated that these payments was made by companies on another identification number. We set out in the table below a summary of the adjustments made to Government Agencies' initial reporting:

Adjustments to Government Entity payments	Total Amount (in MMK)	Commercial Tax	Income Tax (IT)	Custom Duties	Emporium Fees / Sale Fees	Royalties on production - 20% collected by/paid to MGE
NILAR YOMA TRADING	(3,904,922,568)	(2,783,753,984)	(769,094,659)	(352,073,925)	-	-
Thit Sar Pan (U Kyaw Min Naing) (private)	(191,414,970)	-	-	-	(180,401,124)	(11,013,846)
Total added to amounts originally reported	(4,096,337,538)	(2,783,753,984)	(769,094,659)	(352,073,925)	(180,401,124)	(11,013,846)

(c) Taxes received not reported

These are payment flows reported by extractives companies, but which were not reported by Government Agencies. We set out in the table below a summary of the adjustments made to Government Agencies' initial reporting: We set out in the table below a summary of the adjustments made to Government Agencies' initial reporting:

Adjustments to Government Entity payments	Total Amount (in MMK)	Custom Duties	Commercial Tax	Income Tax (IT)	Other Taxes
Ever Winner Gems	306,180,854	47,910,115	202,573,425	55,697,314	-
Myanmar Sithu Jewellery	193,333,801	193,333,801	-	-	-
Yadanar Pyi Phyo Aung Gems And Jewellery Co; Ltd.	130,889,225	62,597,723	-	60,181,772	8,109,730
Jade Padathar Gems + Shwe Gaung Gaung Gems	112,505,025	-	-	-	112,505,025
Linn Lett Win Yadanar Gems	85,272,405	29,914,948	-	55,357,457	-

Other Companies	38,172,849	-	-	-	38,172,849
Total added to amounts originally reported	866,354,159	333,756,587	202,573,425	171,236,543	158,787,604

Appendix 5: Adjustments to Other minerals Sub-sector

Appendix 5.1. Extractive company adjustments

The adjustments were carried out on the basis of confirmations from extractive companies and Government Agencies and were supported by adequate evidence wherever deemed appropriate. The adjustments made are detailed as follows:

Adjustments to Other Minerals companies	Total Amount (in MMK)
Tax amount incorrectly reported	2,099,895,718
Tax paid reported but outside the reconciliation scope	(1,882,869,464)
Tax paid not reported	673,847,579
Tax paid reported but outside the period covered	(48,077,700)
Total adjustments	842,796,132

(a) Tax amount incorrectly reported

These are taxes reported by selected companies and according to receipts not on their names. Accordingly, we adjusted the "Production Split" reported by "Myanmar CNMC Nickel Co; LTD" for an amount of MMK 2,099,895,718 to take into consideration all payments on the name of the company.

(b) Tax paid reported but outside the reconciliation scope

These are payments reported, but not covered by the EITI scope as decided by the MSG. Those payments are as follows:

Adjustments to extractive company payments	Total Amount (in MMK)	Other significant payments (> 50,000 USD)	Income Tax (IT)	Dead Rent Fees	Commercial Tax
National Prosperity Gold Production Group Ltd.	(1,519,916,100)	(1,519,916,100)	-	-	-
Myanmar CNMC Nickel Co; LTD	(199,241,244)	(199,241,244)	-	-	-
Shwe Taung Mining Co., Ltd.	(163,712,120)	-	(58,949,296)	(57,015,800)	(47,747,024)
Total added to amounts originally reported	(1,882,869,464)	(1,719,157,344)	(58,949,296)	(57,015,800)	(47,747,024)

(c) Taxes paid not reported

These are payment flows reported by Government Agencies but were not reported by Mining companies. Adjustments were based on the receipt or confirmation of the company. We set out in the table below a summary of the adjustments made to company payments:

Adjustments to extractive company payments	Total Amount (in MMK)	Production Split	Signature Bonus	Commercial Tax	Royalties	Other Taxes
Shwe Taung Mining Co., Ltd.	625,789,079	533,851,380	-	33,021,265	22,588,200	36,328,234
Myanmar Pongpipat Co.,L td	48,058,500	-	48,058,500	-	-	-
Total added to amounts originally reported	673,847,579	533,851,380	48,058,500	33,021,265	22,588,200	36,328,234

(d) Tax paid reported but outside the period covered by the EITI Report

These are payments reported, but which fall outside the reconciliation period, i.e. before 1 April 2014 or after 31 March 2015. Accordingly, we adjusted the "Dead Rent Fees" reported by "Tha Byu Mining Co., Ltd" for an amount of MMK 48,077,700 to take into consideration only payments on the period covered by the EITI report.

Appendix 5.2. Adjustments to Government Entity templates

The adjustments were carried out on the basis of confirmations received from mineral companies or from Government Agencies and supported by payment receipts wherever deemed appropriate. These adjustments are detailed as follows:

Adjustments to Government Entity payments	Total Amount (in MMK)
Tax received reported but outside the reconciliation scope	(17,822,576,328)
Tax received not reported	65,903,220
Total added to amounts originally reported	(17,756,673,108)

(a) Taxes reported but outside the reconciliation scope

Corresponds to "Income Tax (IT)" amounting to MMK 12,567,774,767 and "Commercial Tax" amounting to MMK 5,254,801,561 reported by IRD as such received from "Myanma Economic Corporation"

(b) Taxes received not reported

These adjustments related to taxes received not reported for a total amount MMK 65,903,220. These are payment flows reported by extractive companies, but which were not reported by Government Agencies. We set out in the table below a summary of the adjustments made to Government Agencies' initial reporting:

Adjustments to Government Entity payments	Total Amount (in MMK)	Commercial Tax on Imports	Dead Rent Fees	Income Tax (IT)
Ruby Dragon Mining Co., Ltd.	45,026,614	23,698,826	21,327,788	-
Myanmar Pongpipat Co.,L td	20,876,606	-	-	20,876,606
Total added to amounts originally reported	65,903,220	23,698,826	21,327,788	20,876,606

Appendix 6: Production and export detail

Appendix 6.a. Oil & Gas

Oil and Condensate	Volumes		Value	
	Oil (Barrels)	Condensate (Barrels)	In million USD	In million MMK
Myanmar Production	1,744,317	2,869,870	383.29	381,476
Myanmar Exports	0	1,376,527	101.00	100,521

Gas	Volumes		Value	
	Gas (MMscf) Offshore	Gas (MMscf) Onshore	In million USD	In million MMK
Myanmar Production	651,584	645	5,928.27	5,900,171
Myanmar Exports	530,469		4,821.56	4,798,711
Domestic Sales	94,799		597.42	594,585

Appendix 6.b. Gems & Jade

Production

	Region	Sharing / Private	Production	Unit	Value (in million MMK)	
Gems	Mogoke	Joint Venture	Ruby & Sapphire	1,027,960	Carat	83.37
			Assorted Colour Gem	35	Kg	1.80
		Private	Ruby & Sapphire	7,424,691	Carat	669.28
			Assorted Colour Gem	8,797	Kg	110.26
	Mong Hsu	Joint Venture	Ruby & Sapphire	53,300	Carat	2.62
		Private	Ruby & Sapphire	2,533,835	Carat	118.81
Total Gems					986.13	
Jade	Kachin State	Joint Venture	Jade	4,404,474	Kg	10,598.33
			Quartzite & Amber	205,511	Kg	
		Private	Jade	11,244,387	Kg	25,148.14
			Quartzite & Amber	315,026	Kg	
	Sagaing Region	Private	Jade	691,219	Kg	32,262
			Quartzite & Amber	32,262	Kg	
Total Jade					35,746.46	
Total					36,732.59	

Emporium sales

	JV/Private	Volume		Sale Price	Volume		Sale Price	Total (in million MMK)
		Carat	Kg	EUR	Carat	Kg	(in million MMK)	
Gems	Joint Venture	659,977	22.82	3,852,840	419,683	0	791,382,400	5,645.31
	Private	542,110	290.91	3,212,026	45,647	119.47	1,168,655,905	5,215.27
Jade	Joint Venture		617,970	252,648,050		3,161,431	23,211,432,570.00	341,505.46
	Private		2,112,545	547,841,700		3,683,923	94,677,049,861	784,865.39
Total								1,137,231.43

Appendix 6.c. Other minerals

SOE	Type	Minerals	Qte	Unit	Amount in million MMK ¹
ME1	Production	Lead Ore	24,309	MT	1,459
ME1	Production	Lead Concentrate	5,403	MT	432
ME1	Production	Zinc Ore	3,030	MT	242
ME1	Production	Copper Ore	10,110	MT	506
ME1	Production	Iron Ore	11,955	MT	454
ME1	Production	Anitimony Ore	10,585	MT	3,705
ME1	Production	Anitimony Concenteate	1,140	MT	570
ME1	Production	Zinc Concentrate	382	MT	57
ME1	Production	Chromium Ore	1,000	MT	80
Sub-total ME (1)					7,505
ME2	Production	Tin	535	MT	4,033
ME2	Production	Tungsten	5	MT	76
ME2	Production	Tin/Tungsten Mixed	487	MT	4,243
ME2	Production	Tin/Tungsten/Scheelite Mixed	614	MT	5,574
ME2	Production	Gold	42,181	Toz	53,202
Sub-total ME (2)					67,129
ME 3	Production	Coal	386,732	MT	420
ME 3	Production	Limestone	1,759,493	MT	2,024
ME 3	Production	Maganese dioxide	17,112	MT	893
ME 3	Production	Marble	6,723	MT	744
ME 3	Production	Granite	330	MT	5
ME 3	Production	Gypsum	104,994	MT	1,050
ME 3	Production	Bauxite	5,845	MT	35
ME 3	Production	Limestone(decorative)	2,133	MT	43
ME 3	Production	Barite	23,060	MT	277
ME 3	Production	White Clay	3,800	MT	23
ME 3	Production	Barite Powder	3,367	MT	337
ME 3	Production	Clay	1,700	MT	10
ME 3	Production	Ferro Nickel	90,621	MT	397,788
ME 3	Production	Dolomite	2,200	MT	10
Sub-total ME (3)					403,659
Total					478,293

¹ Value communicated by ME1 and ME3 on the basis of the average annual price of the commodities

SOE	Type	Minerals	Qte	Unit	Amount in million MMK
ME1	Export	Lead Ore	20,064	MT	2,436
ME1	Export	Lead Concentrate	4,000	MT	2,584
ME1	Export	Copper Ore	100	MT	20
ME1	Export	Iron Ore	1,191	MT	34
ME1	Export	Anitimony Ore	1,985	MT	953
ME1	Export	Anitimony Concenteate	1,500	MT	2,801
ME1	Export	Zinc Ore	825	MT	61
ME1	Export	Cathode Copper	30,125	MT	155,699
ME1	Export	Copper Concentrate	520	MT	310
Sub-total ME (1)					164,897
ME2	Export	Tin Concentrate	247	MT	1,683
ME2	Export	Tin Concentrate	10	MT	78
ME2	Export	Tin&TungstenMixedConcentrate	132	MT	1,253
ME2	Export	Scheelite	59	MT	528
ME2	Export	Scheelite	145	MT	1,631
Sub-total ME (2)					5,172
ME3	Export	Ferro Nicke	90,662	MT	23,530
Sub-total ME (3)					23,530
Total					193,599

Appendix 7: Reporting templates

See excel sheets

Appendix 8: SOEs reconciliation sheets**MOGE**

N°	Description of payment	Paid to	MOGE			MoPF			In MMK
			Initial	Ajust	Final	Initial	Ajust	Final	Final difference
Transfers to budget accounts			1,031,993,296,000	-	1,031,993,296,000	929,341,704,781	102,651,591,219	1,031,993,296,000	-
1	Income Tax (IT)	IRD	357,631,938,000		357,631,938,000	357,631,938,000		357,631,938,000	-
2	Commercial Tax	IRD	368,255,807,000		368,255,807,000	265,604,215,781	102,651,591,219	368,255,807,000	-
3	Customs Duties	Customs Department	20,000,000,000		20,000,000,000	20,000,000,000		20,000,000,000	-
4	State contribution	MoPF (Treasury Department)	286,105,551,000		286,105,551,000	286,105,551,000		286,105,551,000	-
Other accounts - SOE Own Accounts			1,179,203,698,000	-	1,179,203,698,000	1,179,246,838,000	-	1,179,246,838,000	(43,140,000)
5	Transfers to MOGE other accounts (+)	MoPF (Budget Department)	1,179,203,697,902		1,179,203,697,902	1,179,246,838,000		1,179,246,838,000	(43,140,000)
6	Transfers from the Government Budget to MOGE (-)	MoPF (Budget Department)			-			-	-
			1,179,203,698,000	-	2,211,196,994,000	2,108,588,542,781	-	2,108,588,542,781	

- The adjustment made in the Commercial Tax declared by IRD is due to the fact that IRD did not include in its Reporting Template the CT paid by MOGE to the regions revenues offices. During the reconciliation phase IRD confirmed that Commercial Tax amounting MMK 102,651,591,219 was paid by MOGE to regions revenues offices during 2014-2015;
- The difference of MMK (43,140,000) is explained by some receipts declared by the Budget Department but not declared by MOGE. According to MOGE these receipts are as follows:
 - Sales of Tender Form amounting MMK 33,985,000
 - Grease (Engine Oil) Expenses amounting MMK 7,355,000
 - Breach of Agreement amounting MMK 1,800

MGE

N°	Description of payment	Paid to	MGE			MoPF			In MMK
			Initial	Ajust	Final	Initial	Ajust	Final	Final difference
Transfers to budget accounts			137,236,230,000	-	137,236,230,000	137,236,230,000	-	137,236,230,000	-
1	Income Tax (IT)	IRD	75,711,690,000		75,711,690,000	75,711,690,000		75,711,690,000	-
2	Commercial Tax	IRD	29,121,000		29,121,000	29,121,000		29,121,000	-
3	State Contribution	MoPF (Treasury Department)	61,495,419,000		61,495,419,000	61,495,419,000		61,495,419,000	-
Other accounts - SOE Own Accounts			529,258,640,641	(416,863,923,641)	112,394,717,000	113,007,952,000	-	113,007,952,000	(613,235,000)
4	Other Transfers to MGE other accounts (+)	MoPF (Budget Department)	529,258,640,641	(416,863,923,641)	112,394,717,000	113,007,952,000		113,007,952,000	(613,235,000)
5	Transfers from Government Budget to MGE (-)	MoPF (Budget Department)	4,436,212,799		4,436,212,799			-	4,436,212,799
Quasi fiscal expenditure									-
6	In kind payments		-		-				-
7	Cash payments		-		-				-
			666,494,870,641	(416,863,923,641)	249,630,947,000	250,244,182,000	-	250,244,182,000	(613,235,000)

ME1

N°	Description of payment	Paid to	ME1			MoPF			In MMK
			Initial	Ajust	Final	Initial	Ajust	Final	Final difference
Transfers to budget accounts			4,021,565,239	-	4,021,565,239	4,021,565,239	-	4,021,565,239	-
1	Corporate Income Tax (CIT)	IRD	2,161,553,239		2,161,553,239	2,161,553,239		2,161,553,239	-
2	State Contribution	MoPF (Treasury Department)	1,860,012,000		1,860,012,000	1,860,012,000		1,860,012,000	-
Other accounts - SoE Own Accounts			4,365,550,792	-	4,365,550,792	4,365,550,792	-	4,365,550,792	-
3	Transfers to other accounts (+)	MoPF (Budget Department)	4,365,550,792		4,365,550,792	4,365,550,792		4,365,550,792	-
4	Transfers from Government Budget to ME1 (-)	MoPF (Budget Department)	5,408,636,527		5,408,636,527			-	5,408,636,527
			8,387,116,031	-	8,387,116,031	8,387,116,031	-	8,387,116,031	-

ME2

N°	Description of payment	Paid to	ME2			MoPF			In MMK
			Initial	Ajust	Final	Initial	Ajust	Final	Final difference
Transfers to budget accounts			16,131,783,993	-	14,180,102,143	14,002,069,831	178,032,312	14,180,102,143	-
1	Corporate Income Tax (CIT)	IRD	4,229,547,880		4,229,547,880	4,229,547,880		4,229,547,880	-
2	State Contribution	MoPF (Treasury Department)	5,345,808,000		5,345,808,000	5,345,808,000		5,345,808,000	-
3	Commercial Tax	IRD	1,377,629,519		1,377,629,519	1,199,597,207	178,032,312	1,377,629,519	-
4	Royalties	DoM	3,227,116,744		3,227,116,744	3,227,116,744		3,227,116,744	-
5	Signature Bonus/ Application Fees		952,058,500	(952,058,500)	-			-	-
6	Other material transfers (> 50,000 USD)		999,623,350	(999,623,350)	-			-	-
Other accounts - SoE Own Accounts			22,319,595,908	-	22,319,595,908	22,319,595,908	-	22,319,595,908	-
7	Transfers to other accounts (+)	MoPF (Budget Department)	22,319,595,908		22,319,595,908	22,319,595,908		22,319,595,908	-
8	Transfers from Government Budget to ME2 (-)	MoPF (Budget Department)	11,926,508,564		11,926,508,564			-	11,926,508,564
			38,451,379,901	-	36,499,698,052	36,321,665,740	178,032,312	36,499,698,052	-

- The adjustment made in the signature bonus/application fees and other significant transfers is due to the fact that these amounts were wrongly reported by ME2. These are revenues collected by ME2 and not transfers;
- The adjustment made in the Commercial Tax declared by IRD is due to the fact that IRD did not include in its Reporting Template the CT paid by ME2 to the regions revenues offices. During the reconciliation phase IRD confirmed that Commercial Tax amounting MMK 178,032,312 was paid by ME2 to regions revenues offices during 2014-2015;

ME3

N°	Description of payment	Paid to	ME3			MoPF			In MMK
			Initial	Ajust	Final	Initial	Ajust	Final	Final difference
Transfers to budget accounts			1,627,339,000	-	1,627,339,000	1,627,339,000	-	1,627,339,000	-
1	Corporate Income Tax (CIT)	IRD	904,077,000		904,077,000	904,077,000		904,077,000	-
2	State Contribution	MoPF (Treasury Department)	723,262,000		723,262,000	723,262,000		723,262,000	-
Other accounts - SoE Own Accounts			27,534,261,782	-	27,534,261,782	27,650,000,000	-	27,650,000,000	(115,738,218)
3	Transfers to other accounts (+)	MoPF (Budget Department)	27,534,261,782		27,534,261,782	27,650,000,000		27,650,000,000	(115,738,218)
4	Transfers from Government Budget to ME3 (-)	MoPF (Budget Department)	1,504,028,048		1,504,028,048			-	1,504,028,048
			29,161,600,782	-	29,161,600,782	29,277,339,000	-	29,277,339,000	(115,738,218)

Appendix 9: Payment flows description

a. Common law taxes

N°	Payment flows	Definition
Payments to IRD and Custom Department		
1	Income Tax (IT)	An enterprise registered under the Myanmar Companies Act, an entity registered under the Myanmar Foreign Investment Law (MFIL) and a registered Myanmar branch of a foreign entity which enjoys incentives under MFIL are subject to income tax at 25%. A registered Myanmar branch of a foreign entity does not enjoy incentives under MFIL, and other non-resident entities, are subject to income tax at the higher rate of 35%.
2	Commercial Tax	Commercial tax is levied on the sales of goods and services and applies to certain transactions as defined in the Commercial Tax Law. Commercial tax is applied to the gross sales of goods and services. For imported goods, commercial tax is calculated on the "cost, insurance and freight" (CIF) value of goods. Commercial tax is levied at 5% on goods other than exempted goods. Commercial tax is not applicable on exports, except in the case of natural gas, crude oil, jade, gemstones and timber.
3	Stamp Duties	Stamp duty applies to a number of transactions. The Myanmar Stamp Act defines the rules to implement Stamp Duties for various types of instruments payable in Kyats and in other currencies.
4	Capital Gains Tax	The sale or transfer of capital assets are levied for income tax purposes on gains calculated based on the difference between gross sales and the purchase cost of assets plus any additions less depreciation. Capital assets for income tax purposes are defined as lands, buildings, vehicles, or any other asset owned by an entity including shares, bonds and intangibles
5	Withholding tax	Withholding tax is a tax where any person or company making certain payments is required to deduct from such payments and remit to Government Agencies. The payments that attract WHT include management and consultant fees, commissions, rent dividends and payments to non-resident contractors.
6	Other significant payments (> 50,000 USD)	To avoid material omissions, a line entitled "Other significant payments flows" has been included in the reporting template for extractive companies to report any significant payments including any payment flows which are not expected in the reporting template and which are above USD 50,000.
Payments to Custom Department		
1	Commercial Tax	A commercial tax is levied on the sales of goods and services and applies to certain transactions as defined in the Commercial Tax Law. Commercial tax is applied to the gross sales of goods and services. For imported goods, commercial tax is calculated via the "cost, insurance and freight" (CIF) value of goods.
2	Customs Duties	Goods imported in Myanmar are subject to Customs Duties and are required to be declared to the Myanmar Customs Department accordingly. Currently, the Customs Duties levied on the import of machinery, spare parts, and inputs generally range from 0% to 40% of the value of the goods. For exports of goods, export duty is levied on certain commodities.

b. Oil & Gas payments

▪ Payment flows in kind

N°	Payment flows	Definition
Payments to MOGE		
1	State production entitlement	It is the State's entitlement to the Profit Oil/Gas of the Oil and Gas produced.
2	MOGE production entitlement	It is MOGE's entitlement on the Profit Oil/Gas and Cost Oil/Gas of the Oil and Gas produced. All three of the Standard PSCs used by OGPD/EPD contain state buy-in provisions. For onshore blocks, the standard PSC reserves a 15% undivided interest for MOGE, with the option for the state to increase their share up to a 25% undivided interest in the project. For offshore blocks, MOGE has the right to buy-in to the project up to 20% upon a commercial discovery (increasing to 25% if the reserves are greater than 5 TCF).

N°	Payment flows	Definition
3	Royalties	Royalties are charged at the percentage (mentioned in the PSC) of the value of production. The same rate applies for both oil and natural gas. Royalties in Myanmar could be paid in kind or in cash.
4	Baseline payment	In-kind payment made by Oil and Gas onshore companies to MOGE. The amount and payment modalities are detailed in the PCC (Performance Compensation Contracts) and IPR (Improved Petroleum Recovery Contract)..
5	Risk compensation	In-kind payment made by Oil and Gas onshore companies to MOGE. The amount and payment modalities are detailed in the PCC (Performance Compensation) Contracts and IPR (Improved Petroleum Recovery Contract).
6	Payment out of production (-)	The reimbursement of undivided interests by MOGE in the total of the rights and obligations can be made in kind or "Payment out of Production" of fifty percent (50%) of MOGE'S production entitlement under the Contract valued commencing from the beginning of Commercial Production.

▪ Payment flows in cash

N°	Payment flows	Definition
Payments to Ministry of Energy/MOGE		
7	Signature Bonus	Bonus paid upon conclusion of a (Production Sharing Contract (PSC). The amount of the Signature Bonus is specified in the PSC.
8	Royalties	Royalties are charged at percentage (mentioned in the PSC) of the value of production. The same rate applies for both oil and natural gas. Royalties in Myanmar could be paid in kind or in cash.
9	Production Split (State share)	It is the State's entitlement on the Profit Oil/Gas of the Oil and Gas produced. Production of petroleum net of cost is shared between PSC parties, based on a progressive sliding scale linked to average daily production levels from the production area. The rates are distinct for oil and for natural gases.
10	Production Bonus	Bonus paid to MOGE in proportion to the quantities of hydrocarbons produced. The amount of the Production Bonus is specified in the PSC.
11	MOGE share (Profit and Cost)	It is MOGE's entitlement on the Profit Oil/Gas and Cost Oil/Gas of the Oil and Gas produced. All three of the Standard PSCs used by OGP/EPD contain state buy-in provisions. For onshore blocks, the standard PSC reserves a 15% undivided interest for MOGE, with the option for the state to increase its share up to a 25% undivided interest in the project. For offshore blocks, MOGE has the right to buy-in to the project up to 20% upon commercial discovery (increasing to 25% if the reserves are greater than 5 TCF).
12	Dividend	This is the distribution of profits in proportion to the number of shares held directly in the Extractive Company.
13	Training Fund	A training contribution is payable annually by concession holders. Different annual payments apply during the exploration and production periods. The payments to the training fund are not transferred to MOGE, they are held by the extractive companies and managed by a monitoring committee of which MOGE is a member.
14	Research and Development Fund	Contractors should pay an annual contribution to a Research and Development (R&D) Fund from the start of production. This contribution is equal to 0.5% of contractor's share of profit production.
15	Domestic Market Obligation (DMO)	The Contractor's obligatory share of the domestic market obligation will be in the proportion that the Contractor's entitlement to crude oil and gas to all produced in Myanmar, up to 20% of the crude oil allocated to the Contractor.
16	Data fee	Data fee is levied only on offshore blocks. It is payable within 30 days after the signature of the PSC.
17	Land fees/Dead rent fee	Land fees is payable to the Ministry of Environmental Conservation and Forestry. The amount of the land rent is specified in the PSC
18	Other significant payments (> 50,000 USD)	To avoid material omissions, a line entitled "Other significant payments flows" has been included in the reporting template for extractive companies to report any significant payments including any payment flows which are not expected in the reporting template and which are above USD 50,000.
19	Contribution to the State/region social development fund	It is the annual contribution made by Oil and Gas companies to the State/region social development fund.

c. O&G transportation payments

N°	Payment flows	Definition
Payments to MOGE		
1	Profit Sharing Oil and Gas transportation	It is MOGE's share of the Oil and Gas transported via the pipeline.
2	Transit fees Oil and Gas transportation	Transit fees are paid by extractives companies to MOGE for the use of the pipelines.
3	Road right fee Oil and Gas transportation	Road right fees are paid to MOGE by the companies which operate the pipelines.

d. Mining sector payments

▪ Payment flows in kind

N°	Payment flows	Definition
Payments to MONREC		
1	Production Split	Production is shared between the parties. The percentage of the SOE and the percentage of each partner are mentioned in the PSC. The Ministry of Mines share can be increased if production increases.
2	Royalties	Royalties are paid by a mining licence holder to SOEs on the sales value of all products extracted. Royalties for Mining Projects are payable on: -Precious metallic minerals from 5% to 7.5% -Iron, copper, zinc, lead, etc. from 3% to 4%; and Gold, silver, platinum from 4% to 5%.

▪ Cash payment

N°	Payment flows	Definition
Payments to Ministry of Mines Department of Mines N°1 Mining Enterprise (ME1) N°2 Mining Enterprise (ME2) N°3 Mining Enterprise (ME3)		
1	Royalties	Royalties are paid by a mining licence holder to SOEs on the sales value of all products extracted. Royalties for Mining Projects are payable on: -Precious metallic minerals from 5% to 7.5% -Iron, copper, zinc, lead, etc. from 3% to 4%; and -Gold, silver, platinum from 4% to 5%.
2	Signature Bonus	Bonus paid within 30 days after conclusion of mining agreement. The amount of the Signature Bonus is specified in the agreement.
3	Production Split	Production is shared between the parties. The percentages payable to the SOE and to each partner are mentioned in the PSC. The Ministry of Mines' share can be increased if production increases.
4	Dead Rent Fees	Land rent also called "dead rent" is payable during mineral prospecting and exploration stages. The amount of the land rent is specified by the mining agreement.
5	Licence Fees	Fees payable by an applicant of mining rights to be granted a mining license or permit.
6	Application Fees	Fees payable by an applicant for a mining right
7	Dividend	This is the distribution of profits in proportion to the number of shares held directly in the Extractive Company.
8	Other significant payments (> 50,000 USD)	To avoid material omissions, a line entitled "Other significant payments flows" has been included in the reporting template for extractive companies to report any significant payments including any payment flows which are not expected in the reporting templates and which are above USD 50,000.
Payments to MGE		
9	Royalties (20%)	Royalties is levied on the Gems and Jade sales production at the rate of 20% These royalties are paid to MGE.
10	Royalties (10%)	Royalties is levied on the Gems and Jade sales in the annual emporium at the rate of 10%. Royalties is split between IRD (7%) and MGE (3%).
11	Sale Split	It is the share of the State on the revenues of Gems & Jade sales made in te annual

N°	Payment flows	Definition
		emporium.
12	Emporium Fees / Sale Fees	These fees are payable by the participants at the Gems and Jade Emporium.
13	Commercial Tax	A commercial tax is levied on the sales of goods and services and applies to certain transactions as defined in the Commercial Tax Law. The commercial tax arising from the sales of Gems and Jade was collected by MGE in FY 2015-2016.
14	Permit Fee	Permit fees are payable by the holders of Gems and Jade rights
15	Service Fees	Service fees are payables by the participants to the Emporium at the rate of 3% for the raw materials and 1% for the values added products
16	Incentives	These fees are payable at the rate of 1% or 2% only by Joint Venture partners.
N°	Payment flows	Definition
Payments to Forest Department -Ministry of Environmental Conservation and Forestry		
13	Land rental fees	Land rent also called "dead rent" is payable on mineral prospecting and exploration stages. The amount of the land rent is specified by the mining agreement.
14	Environmental / Plantation fees	Environmental / Plantation fees is payable by mining companies when they obtain their mining licenses.
Payments General Administration Department-Ministry of Home Affairs		
15	Mineral taxes	This includes 'fees from licenses for the extraction of minerals such as stone, laterite, limestone, marble, gypsum, clay, or other minerals which are not under the special mining rule.' In some cases, there is a fee per mill or rent per acre; in other cases, as with marble, GAD receives a certain number of kyat per 100 cubic feet extracted.
Payments to States/Regions		
16	Contribution to the State/region social development fund	It is the annual contribution made by companies to the State/region social development fund.

Appendix 10: Detail of Licenses

Appendix 10.a. Oil & Gas

See excel sheets

Appendix 10.b. Gems & Jade

See excel sheets

Appendix 10.c. Other minerals

See excel sheets

Appendix 11: Award Process

Appendix 11.a. Oil & Gas

See excel sheets

Appendix 11.b. Gems & Jade

See excel sheets

Appendix 11.c. Other minerals

See excel sheets

Appendix 12: Standard Terms and Conditions of Oil and Gas contracts

Performance Compensation Contract – PCC Onshore Block

Sr. No.	Particulars	Standard Terms and Conditions of Performance Compensation Contract for Onshore Block(Mann Oil Field)
1,	Contract Area	MANN OIL FIELD
2	Type of Contract	Performance Compensation Contract (PCC)
3	Total Contract Term	(9) years
4	Terms of Contract	(1) Field Management Plan Period (2) Mobilization Period (3) Production Enhancement Operation Period
5	Data Study Fee	US\$ 50,000
6	Signature Bonus	Contractor shall not be obligated to pay any annual bonus,rental,minimum payment or signing bonus.
7	Royalty	-
8	Cost Recovery	Maximum 40% of all Incremental Petroleum.
9	Production Split (Profit Petroleum Allocation)	<u>Incremental Crude Oil</u> <u>MOGE(%)</u> <u>CONT. (%)</u> 65 35
10	Exploration & Development Bonus	Contractor shall not be obligated to pay any annual bonus,rental,minimum payment or signing bonus
11	Production Bonus	Contractor shall not be obligated to pay any annual bonus,rental,minimum payment or signing bonus
12	Domestic Crude Oil Requirement	-
13	State Participation	-
14	Training Fund	-
15	R & D Fund	
16	Income Tax	Myanmar Income Tax Law
17	Governing Law	Laws of the Union of Myanmar.
18	Arbitration	Myanmar Courts of Law
19	Sharing of profit made from o transfer of the shares in Company formed under Section 16.2(p) of the IPR Contract	-

Performance Compensation Contract – IPR Onshore Block

Sr. No.	Particulars	Standard Terms and Conditions of Improved Petroleum Recovery Contract for Onshore Blocks																																				
1,	Contract Area																																					
2,	Area of Block																																					
3,	Type of Contract	Improved Petroleum Recovery Contract (IPR)																																				
4,	Preparation Period	- 6 months (after the signing of the Contract) - Contractor shall conduct Environmental Impact Assessment (EIA) and Social Impact Assessment (SIA) and shall submit the final report including executive summary and mitigation plan to MOGE for MIC approval. Min. Expenditure =US\$ { Contractor shall enter into Exploration Period after approval of MIC on EIA / SIA reports}																																				
5,	Data FeeUS\$ (Payment within 30 days after approval from MIC on EIA / SIA.)																																				
6,	Initial Joint Study Period	Initial Joint Study Period - 6 Months (Existing Petroleum Production for the whole field will be determined by both parties base on the declines curve.) Min. Expenditure =US\$																																				
7,	Signature BonusUS\$ (Payment within 30 days after the commencement of the Pilot Project Period)																																				
8,	Pilot Project Period (Minimum Work Commitment and Expenditure)	<table border="0" style="width: 100%;"> <tr> <td colspan="2"></td> <td style="text-align: right;">Min. Expenditure</td> </tr> <tr> <td style="width: 15%;"></td> <td style="width: 15%; text-align: center;">} Pilot Project Period (3 years)</td> <td style="text-align: right;">..... US\$</td> </tr> <tr> <td style="width: 15%; text-align: center;">Year 1 -</td> <td style="width: 15%; text-align: center;">} FDP will be based on the outcome of Initial Joint</td> <td style="text-align: right;">..... US\$</td> </tr> <tr> <td style="width: 15%; text-align: center;">Study Year 2 -</td> <td style="width: 15%; text-align: center;">Period between MOGE and Contractor.</td> <td style="text-align: right;">..... US\$</td> </tr> <tr> <td></td> <td style="text-align: right;">Year 3 -</td> <td style="text-align: right;">=US\$</td> </tr> <tr> <td></td> <td style="text-align: right;">Total</td> <td></td> </tr> <tr> <td colspan="3" style="text-align: center;">{Contractor will have the option to back-off}</td> </tr> <tr> <td colspan="2">Extension (2 year x 1 time)</td> <td style="text-align: right;">Min. Expenditure</td> </tr> <tr> <td style="width: 15%;"></td> <td style="width: 15%; text-align: center;">} WorkProgram</td> <td style="text-align: right;">..... US\$</td> </tr> <tr> <td style="width: 15%; text-align: center;">Year 4 -</td> <td style="width: 15%; text-align: center;">}</td> <td style="text-align: right;">..... US\$</td> </tr> <tr> <td style="width: 15%; text-align: center;">Year 5 -</td> <td style="width: 15%; text-align: center;">}</td> <td style="text-align: right;">..... US\$</td> </tr> <tr> <td></td> <td style="text-align: right;">Total</td> <td style="text-align: right;">=US\$</td> </tr> </table>			Min. Expenditure		} Pilot Project Period (3 years) US\$	Year 1 -	} FDP will be based on the outcome of Initial Joint US\$	Study Year 2 -	Period between MOGE and Contractor. US\$		Year 3 -	=US\$		Total		{Contractor will have the option to back-off}			Extension (2 year x 1 time)		Min. Expenditure		} WorkProgram US\$	Year 4 -	} US\$	Year 5 -	} US\$		Total	=US\$
		Min. Expenditure																																				
	} Pilot Project Period (3 years) US\$																																				
Year 1 -	} FDP will be based on the outcome of Initial Joint US\$																																				
Study Year 2 -	Period between MOGE and Contractor. US\$																																				
	Year 3 -	=US\$																																				
	Total																																					
{Contractor will have the option to back-off}																																						
Extension (2 year x 1 time)		Min. Expenditure																																				
	} WorkProgram US\$																																				
Year 4 -	} US\$																																				
Year 5 -	} US\$																																				
	Total	=US\$																																				
9,	Production Period	15 years from the date of commercial declaration on incremental petroleum production (or) until the expiration of Contract Term.																																				
10	Royalty	12.5% of all Incremental Petroleum.																																				
11	Cost Recovery	Maximum 40% of all Incremental Petroleum.																																				
12	Profit Petroleum Allocation	<p>Incremental Crude Oil</p> <table border="0" style="width: 100%;"> <thead> <tr> <th>BOPD</th> <th>MOGE(%)</th> <th>CONT(%)</th> </tr> </thead> <tbody> <tr> <td>0 - 5,000</td> <td>60</td> <td>40</td> </tr> <tr> <td>5,001 - 10,000</td> <td>70</td> <td>30</td> </tr> <tr> <td>10,001 - 20,000</td> <td>75</td> <td>25</td> </tr> <tr> <td>20,001 - 30,000</td> <td>80</td> <td>20</td> </tr> <tr> <td>> 30,000</td> <td>85</td> <td>15</td> </tr> </tbody> </table> <p>Incremental Natural Gas</p> <table border="0" style="width: 100%;"> <thead> <tr> <th>MMCFD</th> <th>MOGE(%)</th> <th>CONT(%)</th> </tr> </thead> <tbody> <tr> <td>All</td> <td>60</td> <td>40</td> </tr> </tbody> </table>	BOPD	MOGE(%)	CONT(%)	0 - 5,000	60	40	5,001 - 10,000	70	30	10,001 - 20,000	75	25	20,001 - 30,000	80	20	> 30,000	85	15	MMCFD	MOGE(%)	CONT(%)	All	60	40												
BOPD	MOGE(%)	CONT(%)																																				
0 - 5,000	60	40																																				
5,001 - 10,000	70	30																																				
10,001 - 20,000	75	25																																				
20,001 - 30,000	80	20																																				
> 30,000	85	15																																				
MMCFD	MOGE(%)	CONT(%)																																				
All	60	40																																				
13	Commerciality BonusUS\$ (Payment within 30 days after the commencement of the Production Period)																																				
14	Production Bonus	<table border="0" style="width: 100%;"> <tr> <td style="width: 60%;">Incremental Crude Oil</td> <td></td> </tr> <tr> <td>2,000 BOPD (for 60 consecutive days production)</td> <td>= 0.20 MMUS\$</td> </tr> <tr> <td>5,000 BOPD (for 60 consecutive days production)</td> <td>= 0.50 MMUS\$</td> </tr> <tr> <td>10,000 BOPD (for 60 consecutive days production)</td> <td>= 1.00 MMUS\$</td> </tr> <tr> <td>20,000 BOPD (for 60 consecutive days production)</td> <td>= 2.00 MMUS\$</td> </tr> <tr> <td>30,000 BOPD (for 60 consecutive days production)</td> <td>= 3.00 MMUS\$</td> </tr> <tr> <td>Incremental Natural Gas</td> <td></td> </tr> </table>	Incremental Crude Oil		2,000 BOPD (for 60 consecutive days production)	= 0.20 MMUS\$	5,000 BOPD (for 60 consecutive days production)	= 0.50 MMUS\$	10,000 BOPD (for 60 consecutive days production)	= 1.00 MMUS\$	20,000 BOPD (for 60 consecutive days production)	= 2.00 MMUS\$	30,000 BOPD (for 60 consecutive days production)	= 3.00 MMUS\$	Incremental Natural Gas																							
Incremental Crude Oil																																						
2,000 BOPD (for 60 consecutive days production)	= 0.20 MMUS\$																																					
5,000 BOPD (for 60 consecutive days production)	= 0.50 MMUS\$																																					
10,000 BOPD (for 60 consecutive days production)	= 1.00 MMUS\$																																					
20,000 BOPD (for 60 consecutive days production)	= 2.00 MMUS\$																																					
30,000 BOPD (for 60 consecutive days production)	= 3.00 MMUS\$																																					
Incremental Natural Gas																																						

		15 MMCFD (for 60 consecutive days production) = 0.50 30 MMCFD (for 60 consecutive days production) MMUS\$ 60 MMCFD (for 60 consecutive days production) = 1.00 MMUS\$ 150 MMCFD (for 60 consecutive days production) = 1.50 MMUS\$ production) = 2.00 MMUS\$
15	Domestic Requirement	10% of Crude Oil and 15% of Natural Gas of CONTRACTOR's share of profit petroleum at 75% of Fair Market Prices.
Sr. No.	Particulars	Standard Terms and Conditions of Improved Petroleum Recovery Contract for Onshore Blocks
16	Training Fund	Initial Joint Study Period = 10,000 US\$ Pilot Project Period = 50,000 US\$ per Year Production Period = 50,000 US\$ per Year If any average daily gross production rate exceeds 30,000 BOPD, Production Period = 100,000 US\$ per Year
17	Research and Development Fund	0.5% of CONTRACTOR's share of Profit Petroleum.
18	State Participation.	15 % undivided interest.
19	Income Tax	According to the "Myanmar Income Tax Law"
20	Governing Law	Laws of the Republic of the Union of Myanmar.
21	Arbitration	Myanmar Arbitration Act, 1944.
22	Sharing of Profits made from the sale or transfer of the shares in the Company formed under the contract	If the Company formed under the provisions of the Contract sell or transfer its shares of the Company and if a Profit is being made, CONTRACTOR is liable to pay to the Union Government of the Republic of the Union of Myanmar the following tranches out of the Net Profit made on the sale or transfer of the shares of the Company, registered under the Contract:- - If the amount of Net Profit is up to 100 MMUS\$ 40% - If the amount of Net Profit is between 100 MMUS\$ and 150 MMUS\$ 45% - If the amount of Net Profit is over 150 MMUS\$ 50%
23	EITI	MOGE and CONTRACTOR shall collaborate to implement the Extractive Industries Transparency Initiative.

Performance Compensation Contract – PSC Onshore Block

Sr No.	Particulars	Standard Terms and Conditions of Production Sharing Contract for Onshore Blocks																																										
1,	Contract Area																																											
2,	Area of Block																																											
3,	Type of Contract	Production Sharing Contract (PSC)																																										
4,	Preparation Period	- 6 months (after the signing of the Contract) - Contractor shall conduct Environmental Impact Assessment (EIA) and Social Impact Assessment (SIA) and shall submit the final report including executive summary and mitigation plan to MOGE for MIC approval. Min. Expenditure =US\$ { Contractor shall enter into Exploration Period after approval of MIC on EIA / SIA reports}																																										
5,	Signature BonusUS\$ (Payment within 30 days after approval from MIC on EIA / SIA.)																																										
6,	Exploration Period (Minimum Work Commitment and Expenditure)	- 3 years Min. Expenditure Year 1 - G&G study and Seismic Acquisition, Processing, Interpretation US\$ (API) Year 2 - drill minimum 1 (one) well US\$ Year 3 - post- well evaluation & to drill 1 (one) well US\$ (or) to drill 2 (two) wells during Year 2 & 3 Total US\$ {Contractor will have the option to back-off} 1st Extension (2 year x 1 time) Year 4 - prospect Min. Expenditure evaluation Year 5 - To drill 1 (one) well US\$ US\$ Total US\$ {Contractor will have the option to back-off} 2nd Extension (1 year x 1 time) Year 6 - To drill one (1) appraisal well Min. Expenditure US\$																																										
7,	Production Period	20 years from the date of completion of development in accordance with Development Plan (or) according to Petroleum (Crude Oil / Natural Gas) Sales Agreement, whichever is longer.																																										
8,	Royalty	12.5% of all Available Petroleum.																																										
9,	Cost Recovery	Maximum 50% of all Available Petroleum.																																										
10,	Profit Petroleum Allocation	Crude Oil <table border="1"> <thead> <tr> <th>BOPD</th> <th>MOGE(%)</th> <th>CONT(%)</th> </tr> </thead> <tbody> <tr> <td>0 - 10,000</td> <td>60</td> <td>40</td> </tr> <tr> <td>10,001 - 20,000</td> <td>65</td> <td>35</td> </tr> <tr> <td>20,001 - 50,000</td> <td>70</td> <td>30</td> </tr> <tr> <td>50,001 - 100,000</td> <td>80</td> <td>20</td> </tr> <tr> <td>100,001 - 150,000</td> <td>85</td> <td>15</td> </tr> <tr> <td>> 150,000</td> <td>90</td> <td>10</td> </tr> </tbody> </table> Natural Gas <table border="1"> <thead> <tr> <th>MMCFD</th> <th>MOGE(%)</th> <th>CONT(%)</th> </tr> </thead> <tbody> <tr> <td>up to 60</td> <td>60</td> <td>40</td> </tr> <tr> <td>61 - 120</td> <td>65</td> <td>35</td> </tr> <tr> <td>121 - 300</td> <td>70</td> <td>30</td> </tr> <tr> <td>301 - 600</td> <td>80</td> <td>20</td> </tr> <tr> <td>601 - 900</td> <td>85</td> <td>15</td> </tr> <tr> <td>above 900</td> <td>90</td> <td>10</td> </tr> </tbody> </table>	BOPD	MOGE(%)	CONT(%)	0 - 10,000	60	40	10,001 - 20,000	65	35	20,001 - 50,000	70	30	50,001 - 100,000	80	20	100,001 - 150,000	85	15	> 150,000	90	10	MMCFD	MOGE(%)	CONT(%)	up to 60	60	40	61 - 120	65	35	121 - 300	70	30	301 - 600	80	20	601 - 900	85	15	above 900	90	10
BOPD	MOGE(%)	CONT(%)																																										
0 - 10,000	60	40																																										
10,001 - 20,000	65	35																																										
20,001 - 50,000	70	30																																										
50,001 - 100,000	80	20																																										
100,001 - 150,000	85	15																																										
> 150,000	90	10																																										
MMCFD	MOGE(%)	CONT(%)																																										
up to 60	60	40																																										
61 - 120	65	35																																										
121 - 300	70	30																																										
301 - 600	80	20																																										
601 - 900	85	15																																										
above 900	90	10																																										
11,	Production Bonus	Crude Oil = 0.50 MMUS\$ Upon approval of Development Plan = 1.50 MMUS\$ 10,000 BOPD (for 90 consecutive days production) = 2.00 MMUS\$ 20,000 BOPD (for 90 consecutive days production) = 3.00 MMUS\$ 50,000 BOPD (for 90 consecutive days production) = 4.00 MMUS\$ 100,000 BOPD (for 90 consecutive days production) = 6.00 MMUS\$ 150,000 BOPD (for 90 consecutive days production)																																										

Sr No.	Particulars	Standard Terms and Conditions of Production Sharing Contract for Onshore Blocks
12,	Domestic Requirement	20% of Crude Oil and 25% of Natural Gas of CONTRACTOR's share of profit petroleum at 90% of Fair Market Prices.
13,	Training Fund	Exploration Period = 25,000 US\$ per Year. Production Period = 50,000 US\$ per Year.
14,	Research and Development Fund	0.5% of CONTRACTOR's share of Profit Petroleum.
15,	State Participation.	15 % undivided interest and MOGE has the option to extend up to 25% at its own discretion.
16,	Income Tax	25% on CONTRACTOR's Net Profit. (5 years Tax Holiday starting from the Production.)
17,	Governing Law	Laws of the Republic of the Union of Myanmar.
18,	Arbitration	Myanmar Arbitration Act, 1944.
19,	Sharing of Profits made from the sale or transfer of the shares in the Company formed under the contract	If the Company formed under the provisions of the Contract sell or transfer its shares of the Company and if a Profit is being made, CONTRACTOR is liable to pay to the Union Government of the Republic of the Union of Myanmar the following tranches out of the Net Profit made on the sale or transfer of the shares of the Company, registered under the Contract:- - If the amount of Net Profit is up to 100 MMUS\$ 40% - If the amount of Net Profit is between 100 MMUS\$ and 150 MMUS\$ 45% - If the amount of Net Profit is over 150 MMUS\$ 50%
20,	EITI	MOGE and CONTRACTOR shall collaborate to implement the Extractive Industries Transparency Initiative.

Performance Compensation Contract – PSC Onshore Block Deep

Sr No.	Particulars	Standard Terms and Conditions of Production Sharing Contract for Deep Water Offshore Blocks
1,	Contract Area	
2,	Area of Block	
3,	Water Depth	
4,	Type of Contract	Production Sharing Contract (PSC)
5,	Preparation Period (EIA/SIA/EMP)	- 6 months (after the signing of the Contract) - Contractor shall conduct Environmental Impact Assessment (EIA) and Social Impact Assessment (SIA) and shall submit the final report including executive summary and mitigation plan to MOGE for MIC approval. Min. Expenditure =US\$ {Contractor shall enter into the Study Period after approval of MIC on EIA / SIA reports}
6,	Data Fee	US\$ (if data is available) (Payment within 30 days after commencement of the Study Period)
7,	Study Period (TEA Period)	- 2 years Min. Expenditure US\$ - G&G Study and Seismic Acquisition, Processing, Interpretation {Contractor will have the option to back-off after 2 years Study Period}
8,	Signature Bonus US\$ (Payment within 30 days after entering into the Exploration Period.)
9,	Exploration Period (Minimum Work Commitment and Expenditure)	- 3 years Min. Expenditure Year 1 - Seismic Acquisition, Processing, US\$ Interpretation Year 2 - drill minimum 1 (one) well US\$ Year 3 - post- well evaluation & to drill 1 (one) well US\$ (or) to drill 2 (two) wells during Year 1 to 3 Total US\$ {Contractor will have the option to back-off after 3 years Exploration Period} 1st Extension Period (2 years) Year 4 - prospect Min. Expenditure evaluation Year 5 - To drill 1 (one) well US\$ US\$ Total US\$ {Contractor will have the option to back-off after 2 years 1st Extension Period} 2nd Extension Period (1 year) Min. Expenditure Year 6 - To drill 1 (one) well US\$ {Contractor may enter into Production Period upon commercial discovery}
10,	Production Period	20 years from the date of completion of development in accordance with Development Plan (or) according to Petroleum (Crude Oil / Natural Gas) Sales Agreement, whichever is longer.
11,	Royalty	12.5% of Available Petroleum.
12,	Cost Recovery	Water Depth, less than or equal to 2000 feet 60% more than 2,000 feet 70%
13,	Profit Split (Profit Petroleum Allocation)	Crude Oil Water Depth BOPD MOGE(%) CONT. (%) MOGE(%) CONT. (%) 0 - 25,000 60 40 55 45 25,001 - 50,000 65 35 60 40 50,001 -100,000 75 25 65 35 100,001 - 150,000 80 20 75 25 above 150,000 85 15 80 20 Natural Gas Water Depth MMCFD MOGE(%) CONT. (%) MOGE(%) CONT. (%) 0 - 300 60 40 55 45 301 - 600 70 30 65 35 601 - 900 80 20 75 25 above 900 90 10 80 20

Sr No.	Particulars	Standard Terms and Conditions of Production Sharing Contract for Deep Water Offshore Blocks
14,	Production Bonus	<p>Crude Oil Upon approval of Development Plan = 1.00 MMUS\$ 25,000 BOPD (for 90 consecutive days production) = 2.00 MMUS\$ 50,000 BOPD (for 90 consecutive days production) = 3.00 MMUS\$ 100,000 BOPD (for 90 consecutive days production) = 4.00 MMUS\$ 150,000 BOPD (for 90 consecutive days production) = 5.00 MMUS\$ 200,000 BOPD (for 90 consecutive days production) = 10.00 MMUS\$</p> <p>Natural Gas Upon approval of Development Plan = 1.00 MMUS\$ 150 MMCFD (for 90 consecutive days production) = 2.00 MMUS\$ 300 MMCFD (for 90 consecutive days production) = 3.00 MMUS\$ 600 MMCFD (for 90 consecutive days production) = 4.00 MMUS\$ 750 MMCFD (for 90 consecutive days production) = 5.00 MMUS\$ 900 MMCFD (for 90 consecutive days production) = 10.00 MMUS\$</p>
15,	Domestic Requirement	20% of Crude Oil and 25% of Natural Gas of CONTRACTOR's share at 90% of Fair Market Values.
16,	Training Fund	Exploration Period = 50,000 US\$ per Year. Production Period = 100,000 US\$ per Year.
17,	Research and Development Fund	0.5% of CONTRACTOR's share of Profit Petroleum.
18,	State Participation	Undivided Interest up to 20% after Commercial Discovery and up to 25% if the reserves is greater than 5 TCF Barrel Oil Equivalent.
19,	Income Tax	25% on CONTRACTOR's Net Profit. (5 years Tax Holiday starting from the Production.)
20,	Governing Law	Laws of the Republic of the Union of Myanmar.
21,	Arbitration	UNCITRAL Arbitration Rules.
22,	Sharing of Profits made from the sale or transfer of the shares in the Company formed under the contract	<p>If the Company formed under the provisions of the Contract sell or transfer its Shares of the Company and if a Profit is being made, CONTRACTOR is liable to pay to the Government of the Republic of the Union of Myanmar the following tranches out of the Net Profit made on the sale or transfer of the shares of the Company, registered under the Contract:-</p> <ul style="list-style-type: none"> - If the amount of Net Profit is up to 100 MMUS\$ 40% - If the amount of Net Profit is between 100 MMUS\$ and 150 MMUS\$ 45% - If the amount of Net Profit is over 150 MMUS\$ 50%
23,	EITI	MOGE and CONTRACTOR shall collaborate to implement the Extractive Industries Transparency Initiative.
24,	CSR	Contractor shall expedite the Corporate Social Responsibility (CSR) in the Contract Area as well as for the people of Myanmar in consultation with MOGE according to the Contractor's code of conduct.

Performance Compensation Contract – PSC Onshore Block shallow

Sr. No.	Particulars	Standard Terms and Conditions of Production Sharing Contract for Shallow Water Offshore Blocks																																				
1,	Contract Area																																					
2,	Area of Block																																					
3,	Water Depth																																					
4,	Type of Contract	Production Sharing Contract (PSC)																																				
5,	Preparation Period (EIA/SIA/EMP)	- 6 months (after the signing of the Contract) - Contractor shall conduct Environmental Impact Assessment (EIA) and Social Impact Assessment (SIA) and shall submit the final report including executive summary and mitigation plan to MOGE for MIC approval. Min. Expenditure =US\$ {Contractor shall enter into the Study Period after approval of MIC on EIA / SIA reports}																																				
6,	Data Fee	US\$(Payment within 30 days after commencement of the Study Period)																																				
7,	Study Period	- 6 ~ 12 months Min. Expenditure - Study of existing G&G data and US\$ reprocessing if required {Contractor will have the option to back-off after 6 ~ 12 months Study Period}																																				
8,	Signature Bonus	US\$(Payment within 30 days after entering into the Exploration Period.)																																				
9,	Exploration Period (Minimum Work Commitment and Expenditure)	- 3 years Min. Expenditure Year 1 - Seismic Acquisition, US\$ Processing, Interpretation Year 2 - drill US\$ minimum 1 (one) well US\$ Year 3 - post- well evaluation & to drill 1 (one) well US\$ (or) to drill minimum 2 (two) wells during Year 1 to 3 Total US\$ {Contractor will have the option to back-off after 3 years Exploration Period} 1st Extension Period (2 years) Year 4 - Min. Expenditure prospect evaluation Year 5 - To drill 1 US\$ (one) well US\$ Total US\$ {Contractor will have the option to back-off after 2 years 1st Extension Period} 2nd Extension Period (1 year) Min. Expenditure US\$ Year 6 - To drill 1 (one) well {Contractor may enter into Production Period upon commercial discovery}																																				
10,	Production Period	20 years from the date of completion of development in accordance with Development Plan (or) according to Petroleum (Crude Oil / Natural Gas) Sales Agreement, whichever is longer.																																				
11,	Royalty	12.5% of Available Petroleum.																																				
12,	Cost Recovery	50% of all Available Petroleum for water depth 600 feet or less																																				
13,	Profit Split (Profit Petroleum Allocation)	60% of all Available Petroleum for water depth more than 600 feet Crude Oil <table border="1"> <thead> <tr> <th>Water Depth</th> <th>600 feet or less</th> <th>more than 600 feet</th> </tr> <tr> <th>BOPD</th> <th>MOGE(%) CONT(%)</th> <th>MOGE(%) CONT(%)</th> </tr> </thead> <tbody> <tr> <td>0 - 25,000</td> <td>60 40</td> <td>60 40</td> </tr> <tr> <td>25,001 - 50,000</td> <td>65 35</td> <td>65 35</td> </tr> <tr> <td>50,001 - 100,000</td> <td>80 20</td> <td>75 25</td> </tr> <tr> <td>100,001 - 150,000</td> <td>85 15</td> <td>80 20</td> </tr> <tr> <td>above 150,000</td> <td>90 10</td> <td>85 15</td> </tr> </tbody> </table> Natural Gas <table border="1"> <thead> <tr> <th>Water Depth</th> <th>600 feet or less</th> <th>more than 600 feet</th> </tr> <tr> <th>MMCFD</th> <th>MOGE(%) CONT(%)</th> <th>MOGE(%) CONT(%)</th> </tr> </thead> <tbody> <tr> <td>0 - 300</td> <td>65 35</td> <td>60 40</td> </tr> <tr> <td>301 - 600</td> <td>75 25</td> <td>70 30</td> </tr> <tr> <td>601 - 900</td> <td>85 10</td> <td>80 20</td> </tr> </tbody> </table>	Water Depth	600 feet or less	more than 600 feet	BOPD	MOGE(%) CONT(%)	MOGE(%) CONT(%)	0 - 25,000	60 40	60 40	25,001 - 50,000	65 35	65 35	50,001 - 100,000	80 20	75 25	100,001 - 150,000	85 15	80 20	above 150,000	90 10	85 15	Water Depth	600 feet or less	more than 600 feet	MMCFD	MOGE(%) CONT(%)	MOGE(%) CONT(%)	0 - 300	65 35	60 40	301 - 600	75 25	70 30	601 - 900	85 10	80 20
Water Depth	600 feet or less	more than 600 feet																																				
BOPD	MOGE(%) CONT(%)	MOGE(%) CONT(%)																																				
0 - 25,000	60 40	60 40																																				
25,001 - 50,000	65 35	65 35																																				
50,001 - 100,000	80 20	75 25																																				
100,001 - 150,000	85 15	80 20																																				
above 150,000	90 10	85 15																																				
Water Depth	600 feet or less	more than 600 feet																																				
MMCFD	MOGE(%) CONT(%)	MOGE(%) CONT(%)																																				
0 - 300	65 35	60 40																																				
301 - 600	75 25	70 30																																				
601 - 900	85 10	80 20																																				

Sr. No.	Particulars	Standard Terms and Conditions of Production Sharing Contract for Shallow Water Offshore Blocks
		15 above 90 90 90 10
Sr. No.	Particulars	Standard Terms and Conditions of Production Sharing Contract for Shallow Water Offshore Blocks
14	Production Bonus	<p>Crude Oil Upon approval of Development Plan = 1.00 MMUS\$ 25,000 BOPD (for 90 consecutive days production) = 2.00 MMUS\$ 50,000 BOPD (for 90 consecutive days production) = 3.00 MMUS\$ 100,000 BOPD (for 90 consecutive days production) = 4.00 MMUS\$ 150,000 BOPD (for 90 consecutive days production) = 5.00 MMUS\$ 200,000 BOPD (for 90 consecutive days production) = 10.00 MMUS\$</p> <p>Natural Gas Upon approval of Development Plan = 1.00 MMUS\$ 150 MMCFD (for 90 consecutive days production) = 2.00 MMUS\$ 300 MMCFD (for 90 consecutive days production) = 3.00 MMUS\$ 600 MMCFD (for 90 consecutive days production) = 4.00 MMUS\$ 750 MMCFD (for 90 consecutive days production) = 5.00 MMUS\$ 900 MMCFD (for 90 consecutive days production) = 10.00 MMUS\$</p>
15	Domestic Requirement	20% of Crude Oil and 25% of Natural Gas of CONTRACTOR's share at 90% of Fair Market Values.
16	Training Fund	Exploration Period = 50,000 US\$ per Year. Production Period = 100,000 US\$ per Year.
17	Research and Development Fund	0.5% of CONTRACTOR's share of Profit Petroleum.
18	State Participation	Undivided Interest up to 20% after Commercial Discovery and up to 25% if the reserves is greater than 5 TCF Barrel of Oil Equivalent.
19	Income Tax	25% on CONTRACTOR's Net Profit. (5 years Tax Holiday starting from the Production.)
20	Governing Law	Laws of the Republic of the Union of Myanmar.
21	Arbitration	UNCITRAL Arbitration Rules.
22	Sharing of Profits made from the sale or transfer of the shares in the Company formed under the contract	<p>If the Company formed under the provisions of the Contract sell or transfer its Shares of the Company and if a Profit is being made, CONTRACTOR is liable to pay to the Government of the Republic the Union of Myanmar the following tranches out of the Net Profit made on the sale or transfer of the shares of the Company, registered under the Contract:-</p> <ul style="list-style-type: none"> - If the amount of Net Profit is up to 100 MMUS\$ 40% - If the amount of Net Profit is between 100 MMUS\$ and 150 MMUS\$ 45% - If the amount of Net Profit is over 150 MMUS\$ 50%
23	EITI	MOGE and CONTRACTOR shall collaborate to implement the Extractive Industries Transparency Initiative.
24	CSR	Contractor shall expedite the Corporate Social Responsibility (CSR) in the Contract Area as well as for the people of Myanmar in consultation with MOGE according to the Contractor's code of conduct.

Appendix 13: Oil & gas transportation volume and tariff**MGTC**

Date/month	Volume transported	Unit	Tariff rates (USD/MMBTU)	Block	Company	Amount (in million MMK)
28.4.2014	21,174.62	MMSCF	4.6001	M5, M6	MGTC	6,866.47
27.5.2014	17,531.48	MMSCF	4.6001	M5, M6	MGTC	8,750.58
26.6.2014	16,573.02	MMSCF	4.5594	M5, M6	MGTC	2,623.14
25.7.2014	17,869.72	MMSCF	4.5594	M5, M6	MGTC	7,806.76
27.8.2014	17,132.80	MMSCF	4.5594	M5, M6	MGTC	7,836.20
29.9.2014	17,124.10	MMSCF	4.5522	M5, M6	MGTC	1,184.12
28.10.2014	20,940.84	MMSCF	4.5522	M5, M6	MGTC	10,597.01
27.11.2014	21,772.02	MMSCF	4.5522	M5, M6	MGTC	10,709.56
22.12.2014	19,673.25	MMSCF	4.5209	M5, M6	MGTC	2,639.77
28.1.2015	18,541.48	MMSCF	4.5209	M5, M6	MGTC	9,494.51
26.2.2015	16,385.00	MMSCF	4.5209	M5, M6	MGTC	7,954.36
26.3.2015	17,515.00	MMSCF	4.2552	M5, M6	MGTC	2,482.67
Total						78,945.13

TPC

Date/month	Volume transported	Unit	Tariff rates (USD/MMBTU)	Block	Company	Amount (in million MMK)
7.4.2014	10,533.61	MMSCF	4.2681	M12,M13,M14	TPC	8,482.67
9.5.2014	11,754.25	MMSCF	4.2681	M12,M13,M14	TPC	9,677.04
11.6.2014	11,670.20	MMSCF	4.2303	M12,M13,M14	TPC	9,335.59
4.7.2014	12,678.83	MMSCF	4.2303	M12,M13,M14	TPC	9,660.80
7.8.2014	11,250.42	MMSCF	4.2303	M12,M13,M14	TPC	8,896.59
8.9.2014	10,475.12	MMSCF	4.2236	M12,M13,M14	TPC	8,095.47
10.10.2014	10,713.49	MMSCF	4.2236	M12,M13,M14	TPC	8,519.27
10.11.2014	9,959.46	MMSCF	4.2236	M12,M13,M14	TPC	7,631.43
8.12.2014	10,013.11	MMSCF	4.1946	M12,M13,M14	TPC	7,610.97
9.1.2015	11,061.95	MMSCF	4.1946	M12,M13,M14	TPC	8,754.61
10.2.2015	10,235.43	MMSCF	4.1946	M12,M13,M14	TPC	8,186.72
6.3.2015	10,074.55	MMSCF	3.948	M12,M13,M14	TPC	7,428.13
Total						102,279.29

ATL

Date/month	Volume transported	Unit	Tariff rates (USD/MMBTU)	Block	Company	Amount (in million MMK)
14-Aug	6,199.76	MMSCF	4.6928	M9	ATL	No payments - loan repayment period
14-Sep	8,072.36	MMSCF	4.6928	M9	ATL	
14-Oct	8,616.27	MMSCF	4.6606	M9	ATL	
14-Nov	7,427.33	MMSCF	4.6606	M9	ATL	
14-Dec	6,646.75	MMSCF	4.6606	M9	ATL	
15-Jan	6,427.99	MMSCF	4.3867	M9	ATL	
15-Feb	6,623.12	MMSCF	4.3867	M9	ATL	
15-Mar	7,611.40	MMSCF	4.3867	M9	ATL	

SEAGP

Date/month	Volume transported	Unit	Tariff rates (USD/MMBTU)	Block	Company	Amount (in million MMK)
Apr-14	8,226.94	MMSCF	2.8950	A1,A3	SEAGP	-
May-14	9,509.29	MMSCF	2.8950	A1,A3	SEAGP	-
Jun-14	7,960.23	MMSCF	2.8950	A1,A3	SEAGP	-
Jul-14	6,984.86	MMSCF	2.8950	A1,A3	SEAGP	-
Aug-14	11,769.80	MMSCF	2.8950	A1,A3	SEAGP	-
Sep-14	11,797.54	MMSCF	2.8950	A1,A3	SEAGP	-
Oct-14	11,992.10	MMSCF	2.8950	A1,A3	SEAGP	-
Nov-14	11,777.05	MMSCF	2.8950	A1,A3	SEAGP	-
Dec-14	15,617.98	MMSCF	2.8950	A1,A3	SEAGP	-
Jan-15	16,009.77	MMSCF	2.8950	A1,A3	SEAGP	-
Feb-15	11,212.66	MMSCF	2.8950	A1,A3	SEAGP	-
Mar-15	12,155.22	MMSCF	2.8950	A1,A3	SEAGP	-

Appendix 14: Detail of Submission of the Reporting templates by extractive companies

Oil and Gas companies

Oil and Gas companies for the reconciliation scope 2014-2015			Soft copy	Hard copy	Audited Report
		Company			
SOE	1	MOGE	Yes	Yes	Yes
	2	Petronas Carigali Hong Kong Ltd (PCML)	Yes	Yes	Yes
	3	Total	Yes	Yes	Yes
Operators in producing fields	4	Daewoo International Corporation	Yes	Yes	Yes
	5	PTTEP International Ltd.	Yes	Yes	Yes
	6	Goldpetrol Co Ltd	Yes	Yes	Yes
	7	MPRL E&P Pte Ltd	Yes	Yes	Yes
Partners in the producing fields	8	Nippon Oil	No	No	No
	9	ONGC Videsh Ltd	Yes	Yes	Yes
	10	Gail JJ India Ltd	Yes	No	Yes
	11	Korea Gas Corporation	Yes	Yes	No
	12	Unocal Myanmar Offshore Co., Ltd	Yes	Yes	Yes
Operators in exploration phase	13	Petronas Carigali Myanmar Inc (PCMI)	Yes	Yes	Yes
	14	Geopetrol International Holding Inc	Yes	Yes	No
	15	Jubilant Oil & Gas Pte.Ltd	No	No	No
	16	PTTEP South Asia Ltd	Yes	Yes	Yes
	17	IsTech Energy EP5 Pte	Yes	Yes	No
	18	Asia Orient International Ltd	No	No	No
	19	CNPC International Ltd	Yes	Yes	No
	20	SNOG Pte Ltd	Yes	Yes	No
	21	Eni Myanmar BV	Yes	Yes	Yes
	22	Central Asia Oil and Gas (CAOG) Pte. Ltd	Yes	Yes	Yes
Operators awarded O&G Blocks in 2014 and 2015 (in Study phase)	23	Pacific Hunt Energy Corporation	Yes	Yes	Yes
	24	Bashneft International B.V	Yes	Yes	No
	25	Brunei National Petroleum Co	Yes	Yes	Yes
	26	Petrovietnam Exploration Production Corporation	No	No	No
	27	Oil India Ltd	No	No	No
	28	Ophir Myanmar Ltd	Yes	Yes	No
	29	Barlanga Myanmar Pte. Ltd.	Yes	Yes	Yes
	30	Shell Myanmar Energy Pte.Ltd	Yes	Yes	No
	31	BG Exploration & Production Myanmar Pte. Ltd.	Yes	Yes	Yes
	32	Woodside Energy (Myanmar) Pte. Ltd.	Yes	Yes	No
	33	CFG Energy Pte.Ltd.	No	No	No
	34	Reliance Industries Ltd	No	No	No
	35	Statoil Myanmar Pte. Ltd.	Yes	Yes	Yes
	36	Tap Energy Pte. Ltd.	No	No	No

Oil and Gas transportation companies

Oil and Gas Transportation companies for the reconciliation scope 2014-2015 and 2015-2016		Soft copy	Hard copy	Audited Report
1	Andaman Transportation Limited (ATL)	Yes	Yes	Yes
2	Moattama Gas Transportation Company (MGTC)	Yes	Yes	Yes
3	Taninthayi Pipeline Company (TPC)	Yes	Yes	Yes
4	South-East Asia Gas Pipeline Co (SEAGP)	Yes	Yes	Yes
5	South East Asia Crude Oil Pipeline Co, Ltd (SEACOP)	No	No	No

Gems and Jade companies

N°	Gems and Jade companies for the reconciliation scope 2014-2015	Soft copy	Hard copy	Audited Report
1	Myanmar Win Gate Gems & Jewellery Mining	Yes	Yes	Yes
2	Sein Lom Taung Tan Gems Ltd. (*)	Yes	Yes	Yes
3	Yar Za Htar Ne Gems Co;Ltd. (*)	Yes	Yes	Yes
4	Myanmar Imperial Jade(Gems & Jewellery) (*)	Yes	Yes	Yes
5	Wai Aung Gabar Gems Co; Ltd. (*)	Yes	Yes	Yes
6	Ayar Jade Co; Ltd.	Yes	Yes	Yes
7	Myat Yamon Gems Co;Ltd. (*)	Yes	Yes	Yes
8	Kyauk Seinn Nagar (Gems) (*)	Yes	Yes	Yes
9	Myanmar Sithu Jewellery (*)	Yes	Yes	Yes
10	Linn Lett Win Yadanar Gems (*)	Yes	Yes	Yes
11	Yadanar Taung Tann Gems (*)	Yes	Yes	Yes
12	Khin Zaw Aung & Brothers Gems & Jewellery (*)	Yes	Yes	Yes
13	Shwe Gaung Gaung Gems	Yes	Yes	Yes
14	Xie Family (*)	Yes	Yes	Yes
15	Great Genesis Gems Co; Ltd. (*)	Yes	Yes	Yes
16	Richest Gems Co;Ltd. (*)	Yes	Yes	Yes
17	Kyaing International Gems (*)	Yes	Yes	Yes
18	Phyo Thiha Kyaw Gems	Yes	Yes	Yes
19	Myanma Gon Yi Gems & Jewellery	N/A		
20	Kyaw Naing & Brothers	Yes	Yes	Yes
21	Kyay Sin Phyu	Yes KYEI	Yes	Yes
22	HTOO JEWELLERY CO.,LTD.	Yes	Yes	Yes
23	Ngwe Hein Htet Gems & Jewellery	Yes	Yes	Yes
24	Lyan Shan Jewellery Co; Ltd.	Yes	Yes	Yes
25	Yadanar Pyi Phyo Aung Gems And Jewellery Co; Ltd.	Yes	Yes	Yes
26	PAING PHYO THIIHA GEMS	Yes	Yes	Yes
27	EIGHTY THOUSAND GEMS & JEWELLERY Co;Ltd	Yes	Yes	Yes
28	Tun Naing Aung Gems	Yes	Yes	Yes
29	Thit Sar Pan (U Kyaw Min Naing) (private)	Yes	Yes	Yes
30	Chaow Brothers Gemstone	Yes	Yes	Yes
31	Mann Ayer Family Co.,Ltd.	Yes	Yes	No
32	(1.1.1) Gems & Jewellery (*)	Yes	Yes	Yes
33	Oo Ya Gems & Jewellery Co;Ltd.	Yes	Yes	Yes
34	Yaza Htarne	N/A same as 3		
35	Myanmar Economics Corporation	Yes	Yes	Yes
36	Pang Huke Duwa Co; Ltd.	Yes	Yes	Yes

37	Khun Pa-Oh Gems & Jewellery	Yes	Yes	Yes
38	Kachin National Development	Yes	Yes	Yes
39	Silver Elephant Gems	Yes	Yes	Yes
40	Myo Nwe Gems & Jewellery	Yes	Yes	Yes
41	Shining Star Light Gems & Jewellery (*)	Yes	Yes	Yes
42	Myanma Seinn Lei Aung Gems	Yes	Yes	Yes
43	Myanmar Naing Group	Yes	Yes	Yes
44	Pho Thar Htoo Gems Co; Ltd.	Yes	Yes	Yes
45	RUBY DRAGON JADE & GEMS Co.,Ltd	Yes	Yes	Yes
46	Thi Raw Mani Gems & Jewellery (*)	Yes	Yes	Yes
47	Kan Par Ni Gems & Jewellery Co.,Ltd.	Yes	Yes	Yes
48	Golden Grate Wall Gems Co., Ltd	Yes	Yes	Yes
49	Kyauk Gyi Gone Gems & Jewellery Co., Ltd	Yes	Yes	Yes
50	Phar Kant Yar Zar Gems & Jewellery Co.,Ltd	Yes	Yes	Yes
51	Zwe Htet Lwin Gems & Jewellery Co.,Ltd	Yes	Yes	Yes
52	Lin Yaung Phyar Gems Co.,Ltd	Yes	Yes	Yes
53	Kaung Wai Yan Gems Co,Ltd	Yes	Yes	Yes
54	Yadanar San Shwin Gems Co., Ltd	Yes	Yes	Yes
55	SHWE BYAIN PHYU CO	Yes	Yes	Yes
56	NILAR YOMA TRADING	Yes	Yes	Yes
57	Jade Mountain Gems Co;Ltd. (*)	Yes	Yes	Yes
58	Ever Winner Gems (*)	Yes	Yes	Yes
59	Than Lwin Aye Yar Gems Co., Ltd. (Kaung Myat Thu Kha Co. LtdK)	Yes	Yes	Yes
60	Jade Padathar Gems + Shwe Gaung Gaung Gems	Yes	Yes	Yes
61	Khine Myanmar Gems Co;Ltd.	Yes	Yes	Yes
62	Kan Pwint Oo	Yes	Yes	Yes
63	KHA YANN MYAY GEMS	Yes	Yes	Yes
64	Kyay Lin	Yes	Yes	Yes
65	Kyaw Thet Aung	Yes	Yes	Yes
66	Thirawmani Gems & Jewellery Co.,Ltd	N/A same as 46		
67	Aung Hein Min Gems Co.,Ltd	Yes	Yes	Yes
68	YadanarYaungChi Gems Co.,Ltd	Yes	Yes	Yes
69	Yadanar Kaung Kin Gems & JewelleryCo;Ltd	Yes	Yes	Yes
70	Big Jade Gems Co.,Ltd.	Yes	Yes	Yes
71	Golden Wallet Jewellery Co.,Ltd	Yes	Yes	Yes
72	Tun Tauk Sa Gems Co.,Ltd.	Yes	Yes	Yes

 Audit report submitted after the deadline

Other minerals companies

N°	Company	Soft copy	Hard copy	Audited Report
1	Myanmar CNMC Nickel Co; LTD (*)	Yes	Yes	Yes
2	Myanma Economic Corporation	Yes	Yes	Yes
3	Ruby Dragon Mining Co., Ltd.	Yes	Yes	Yes
4	Shwe Taung Mining Co., Ltd.	Yes	Yes	Yes
5	NgweYi Palae Mining Co.,Ltd (*)	Yes	Yes	Yes
6	Win Myint Mo Industries Co.,Ltd (*)	Yes	Yes	No
7	Tha Byu Mining Co.,Ltd (*)	Yes	Yes	Yes
8	GPS Joint Venture Co., Ltd. (*)	Yes	Yes	Yes
9	Electrum Mining Co; Ltd	Yes	Yes	Yes
10	Max Myanmar Industry Co;.,Ltd (*)	Yes	Yes	Yes
11	Htoo International Industrial Gorup Co.,Ltd	Yes	Yes	Yes
12	Tun Thwin Mining Co., Ltd	Yes	Yes	Yes
13	Shwe Moe Yan Co.,Ltd	Yes	Yes	Yes
14	Myanmar Yang Tse Copper Ltd (*)	Yes	Yes	Yes
15	Sea Sun Star Mining Production & Marketing Co.,Ltd	Yes	Yes	Yes
16	Eastern Mining Co.,Ltd	Yes	Yes	Yes
17	Swan Yadanar Htay Mining Co;Ltd	Yes	Yes	Yes
18	Swan Min Htet Mining Co;Ltd	Yes	Yes	Yes
19	Aung Brother Mining Co;Ltd	Yes	Yes	Yes
20	Eternal Mining Co., Ltd (*)	Yes	Yes	Yes
21	National Prosperity Gold Production Group Ltd.	Yes	Yes	Yes
22	Geo Asia Industrial and Mining Co., Ltd.	Yes	Yes	Yes
23	Myanmar Golden Point Family Co., Ltd.	Yes	Yes	Yes
24	THAN TAW MYAT CO,LTD	Yes	Yes	Yes
25	BAGAN BUSINESS GROUP	Yes	No	No
26	Delco Co.,Ltd (*)	Yes	Yes	Yes
27	Myanmar Pongpipat Co.,L td (*)	Yes	Yes	Yes
28	Kayar Mine Production Co., Ltd	Yes	Yes	Yes
29	Ye Htut Kyaw Mining Co.,Ltd	Yes	Yes	Yes

 Audit report submitted after the deadline

Appendix 15: Breakdown of the social payments by beneficiary and by project

No.	Company	Beneficiary Identity	Beneficiary Location	Date	In Kind payments (Projects)	Cash payment	
					Description of the projects (activities undertaken, beneficiaries, objectives..)	Amount (USD)	Amount (MMK)
Oil&Gaz						4 809 582 527	
1	Petronas Carigali Hong Kong Ltd	N/C	Miscellaneous		N/C	815 951	812 083 177
		Ministry of Education	Kyaukpyu		Construction of Three New School Buildings at Gonechwein, Malakyun & Sittaw Villages	362 094	360 377 733
		Ministry of Education	Kyaukpyu		Establishment of IT Classroom at Malakyun Affiliated Middle School	6 956	6 922 940
		Ministry of Education	Kyaukpyu		Provision of Teaching Aids & School Furniture	26 985	26 857 105
		Ministry of Education	Kyaukpyu		Maintenance of Donated School Buildings	33 070	32 912 975
		10 Deserving Students	Rakhine State		Shwe Scholarship Program	4 000	3 981 041
		Ministry of Education	Kyaukpyu		Provision of Computer Training Courses at Gonechwein High School	7 347	7 312 157
		Ministry of Health	Kyaukpyu		Construction of Sub Rural Health Centers in Gonechwein & Malakyun	37 464	37 286 894
		Ministry of Health	Kyaukpyu		Donation of an Ambulance to Kyaukpyu Hospital	32 783	32 627 783
		Ministry of Health	Kyaukpyu		Provision of Medical Equipment to Kyaukpyu Hospital	20 670	20 572 028
2	Daewoo International Corporation	Ministry of Health Residents from Rural Area of Kyaukpyu District	Sittwe / Rakhine State		Construction of Sub Rural Health Center at Ahmyintkyun Village & Provision of Medicines in Sittwe Township	52 324	52 075 843
		Students from Kyaukpyu Township	Kyaukpyu		Sponsorship of Auxiliary Midwives Training at Kyaukpyu Hospital	7 226	7 191 690
		Residents from Gonechwein Village	Kyaukpyu		Provision of Medical Equipment for School Health Program by Kyaukpyu Hospital	8 000	7 962 081
		Residents from Gonechwein Village	Kyaukpyu		Provision of Pit Latrine (FOC) to the Poor Family from Gonechwein Villages	12 812	12 750 786
		Residents from Kyaukpyu Township	Kyaukpyu		Upgrading Interconnection Road at Gonechwein (Phase I - 1.00 km)	298 814	297 397 670
		Ministry of Education	Yanbye / Kyaukpyu District		Construction of No.3 Local Jetty (Final Payment after completion of 1 year Warranty period)	62 121	61 826 955
		Tree Growers & Local Residents from Kyaukpyu Township	Kyaukpyu		Construction of Embankment & Sluice Gate at Yanbye High School (Final Payment after completion of 1 year Warranty period)	15 002	14 930 594
					Mangrove Forest Conservation Project	131 156	130 534 342

No.	Company	Beneficiary Identity	Beneficiary Location	Date	In Kind payments (Projects)	Cash payment	
					Description of the projects (activities undertaken, beneficiaries, objectives..)	Amount (USD)	Amount (MMK)
3	Goldpetrol Co Ltd	Local Residents from Kyaukpyu Township	Kyaukpyu		Waste Management Program (Provision of 660 liter Mobile Garbage Bins)	41 486	41 289 025
		Local Residents from Kyaukpyu Township	Kyaukpyu		Monitoring & Evaluation of Previous Mangrove Conservation Program (Third Party)	16 528	16 449 660
		Yenangyaung	Yenangyaung, Magway		N/C	N/A	55 819 000
		Chauk	Chauk, Magway		N/C	N/A	102 979 400
4	MPRL E&P Pte Ltd	N/C	N/C	N/C	N/C	N/C	313 450 321
5	PTTEP International Ltd.	Health School Program	Operation area and Vicinity Yangon area and other area in Myanmar		N/C	50 035	49 797 842
		Scholarship			N/C	241 224	240 080 638
		Technical Capacity Building and Development program			N/C	137 862	137 208 557
		Infrastructure Improvement (Construction school building, road improvement, renovation monastery etc.)			N/C	262 876	261 630 011
		Utility Supply Improvement (Provision electricity, water supply system etc.)			N/C	28 074	27 940 934
		Miscellaneous (Support village and school activities, emergency relief etc.)			N/C	53 365	53 112 059
		Mobile Health check program	Operation area and Vicinity Yangon area and other area in Myanmar		N/C	11 730	11 674 402
		Technical Capacity Building and Development program			N/C	48 090	47 862 061
		Infrastructure Improvement (Construction school building, road improvement, renovation monastery etc.)			N/C	75 854	75 494 464
		Miscellaneous (Support village and school activities, emergency relief etc.)			N/C	9 170	9 126 536
6	Unocal Myanmar Offshore Co., Ltd	PACT INSTITUTE, INC.	Dry Zone region	20-nov-14	N/C	203 225	202 261 746
		PACT INSTITUTE, INC.	Dry Zone region	11-mars-15	N/C	1 069 068	1 064 000 791
7	PTTEP South Asia Ltd	(A) Technical Capacity Building and Development program			N/C	28 641	28 505 246
		(A) Infrastructure Improvement (Construction school building, road improvement, renovation monastery etc.)			N/C	18 206	18 119 707
		(B) Miscellaneous (Support village and school activities, emergency relief etc.)			N/C	8 949	8 906 583
		(A) Mobile Health check program	Operation area and Vicinity Yangon area and other area in Myanmar		N/C	13 194	13 131 463
		(A) Technical Capacity Building and Development program			N/C	28 641	28 505 246
		(A) Infrastructure Improvement (Construction school building,			N/C	9 498	9 452 981

No.	Company	Beneficiary Identity	Beneficiary Location	Date	In Kind payments (Projects)		Cash payment	
					Description of the projects (activities undertaken, beneficiaries, objectives..)	Amount (USD)	Amount (MMK)	
		road improvement, renovation monastery etc.) (B) Miscellaneous (Support village and school activities, emergency relief etc.)			N/C		5 000	4 976 301
8	Woodside Energy Pte. Ltd.	University of Western Australia	Australia	21/04/2014	Postgraduate Scholarship for Myanmar Nationals undertaking study in Australia		62 500	62 203 760
Transportation								4 500 070 258
		N/C	N/C	N/C	Management -Staff cost		364 116	362 390 139
		N/C	N/C	N/C	KBK OFFICE Running Costs		410 749	408 802 395
		N/C	N/C	N/C	Public health		385 483	383 655 395
		N/C	N/C	N/C	Community development and communication		94 709	94 259 766
		N/C	N/C	N/C	Education		108 983	108 466 110
		N/C	N/C	N/C	Agriculture		177 758	176 915 197
		N/C	N/C	N/C	Veterinary		188 566	187 671 929
		N/C	N/C	N/C	Infrastructure		423 782	421 773 243
1	Moattama Gas Transportation Company	N/C	N/C	N/C	Tannitharyi Natural Reserve		150 000	149 289 024
		N/C	N/C	N/C	Micro-Credit		61 957	61 662 846
		N/C	N/C	N/C	CSR Yangon orphanages program & Yadanar Foster Home		272 777	271 484 380
		N/C	N/C	N/C	Blindness prevention program in central Myanmar		88 050	87 632 896
		N/C	N/C	N/C	HIV/AIDS program in Mandalay + Pakokku		800 000	796 208 130
		N/C	N/C	N/C	Other Support Programs + Stakeholder Engagement + Program Outcomes & Impact Assessment Survey (CDA Collaborative Learning Projects)		388 946	387 102 539
		N/C	Naratekhant Village, Shan State	4.10.2014	B.E.P. School		55 000	54 739 309
		N/C	Pantintaung Yehaw Village, Shan State	4.10.2014	B.E.P. School		55 000	54 739 309
2	South-East Asia Gas Pipeline Co (SEAGP)	N/C	Aye Swa Village, Tanhtaroo Twp, Mandalay	17.5.2017	B.E.P. School		44 500	44 289 077
		N/C	Manhay Village Hti Pal Twp,Shan State	19.5.2014	B.E.P. School		27 500	27 369 654
		N/C	Mine Mu Village, Namtu Twp, Shan State	19.5.2014	B.E.P. School		41 290	41 094 292
		N/C	Naung Pat Village, Mang Ton Twp, Shan State	19.5.2014	B.E.P. School		32 000	31 848 325

No.	Company	Beneficiary Identity	Beneficiary Location	Date	In Kind payments (Projects)		Cash payment	
					Description of the projects (activities undertaken, beneficiaries, objectives..)	Amount (USD)	Amount (MMK)	
		N/C	Maw Htie Village, Mang Ton Twp, Shan State	19.5.2014	B.E.P. School	32 000	31 848 325	
		N/C	Wine Pat Village, Mang Ton Twp, Shan State	19.5.2014	B.E.P. School	35 000	34 834 106	
		N/C	PanYoke Village, Namkan Twp, Shan State	19.5.2014	B.E.P. School	35 000	34 834 106	
		N/C	LwanHan Village, Namkan Twp, Shan State	19.5.2014	Brick Camp Building for Orphanage	42 000	41 800 927	
		N/C	Manst Village, Namkan Twp, Shan State	19.5.2014	B.E.P. School	55 000	54 739 309	
		N/C	Dopin Village, Pyin Oo Lwin	27.5.2014	Brick Camp Building for Orphanage	63 500	63 199 020	
		N/C	Htanaungpinlae Village, Nwar Hto Gyi Twp	23.6.2014	Village Power Network Project	87 837	87 420 508	
Gems& Jade								17 887 000
1	Ngwe Hein Htet Gems & Jewellery	N/C	N/C	N/C	N/C	N/C	6 687 000	
		N/C	Mogoke	3.12.2014	N/C	N/A	300 000	
		N/C	Mogoke	3.7.2014	N/C	N/A	300 000	
		N/C	Mogoke		N/C	N/A	2 000 000	
		N/C	Mogoke		N/C	N/A	500 000	
2	Lyan Shan Jewellery Co; Ltd.	N/C	Mogoke	31.3.2015	N/C	N/A	5 000 000	
		N/C	Mogoke	23.5.2014	N/C	N/A	500 000	
		N/C	Mogoke	6.4.2014	N/C	N/A	500 000	
		N/C	Mogoke	13.5.2014	N/C	N/A	100 000	
		N/C	Mogoke	20.6.2014	N/C	N/A	2 000 000	
Other Minerals								2 865 382 913
1	Myanmar CNMC Nickel Co; LTD	N/C	N/A	April 2014	N/C	N/A	1 050 000	
		N/C	N/A	May 2014	N/C	N/A	52 000 000	
		N/C	N/A	June 2014	N/C	N/A	20 000 000	

No.	Company	Beneficiary Identity	Beneficiary Location	In Kind payments (Projects)		Cash payment	
				Date	Description of the projects (activities undertaken, beneficiaries, objectives..)	Amount (USD)	Amount (MMK)
		N/C	N/A	August 2014	N/C	N/A	100 000 000
		N/C	N/A	August 2014	N/C	N/A	450 000
		N/C	N/A	September 2014	N/C	N/A	133 000
		N/C	N/A	November 2014	N/C	N/A	10 000 000
		N/C	N/A	November 2014	N/C	N/A	2 000 000
		N/C	N/A	December 2014	N/C	N/A	21 000 000
		N/C	N/A	December 2014	N/C	N/A	10 000 000
		N/C	N/A	February 2015 Comments (We donated \$8000 = 7880480 MMK)	N/C	N/A	7 880 480
		N/C	N/A	February 2015	N/C	N/A	500 000
		N/C	N/A	February 2015	N/C	N/A	123 216 700
		N/C	N/A	March 2015	N/C	N/A	210 000
		N/C	N/A	From April 2014 to March 2015	N/C	N/A	4 200 000
		N/C	N/A	From April	N/C	N/A	12 316 736

No.	Company	Beneficiary Identity	Beneficiary Location	Date	In Kind payments (Projects)		Cash payment	
					Description of the projects (activities undertaken, beneficiaries, objectives..)	Amount (USD)	Amount (MMK)	
		N/C	N/A	2014 to March 2015	N/C		N/A	18 487 857
2	NgweYi Palae Mining Co.,Ltd	N/C	N/C	N/C	N/C		N/C	201 272 500
3	Win Myint Mo Industries Co.,Ltd	Public	N/C	N/C	North Shan State		N/C	7 638 290
		Public	N/C	N/C	North Shan State		N/C	13 650 550
4	Tun Thwin Mining Co., Ltd	N/C	N/C	N/C	N/C		N/C	29 491 850
		Education	War Phu Taung , Kyaung Kone,Chaung Phyar Village , Yamethin Township	2014-2015	N/C		N/A	8 830 000
5	Shwe Moe Yan Co.,Ltd	Health Care	N/C		N/C		N/A	9 840 000
		Road construction	N/C		N/C		N/A	5 885 000
		Religious	N/C		N/C		N/A	7 010 000
		Social Expenditure	N/C	(2011 to 2014'March)	N/C		N/A	230 390 000
6	Sea Sun Star Mining Production & Marketing Co.,Ltd	N/C	N/C	N/C	N/C		N/C	70 000 000
		N/C	Bawapin (Dawei)	30.04.2014				170 000
		N/C	Bawapin (Dawei)	31.05.2014				170 000
		N/C	Bawapin (Dawei)	30.06.2014				170 000
7	Eastern Mining Co.,Ltd	N/C	Bawapin (Dawei)	31.07.2014	5 person teachers and 1 person doctor per 20,000 kyats and donate to Bawapin monestry 50,000 kyats per month			170 000
		N/C	Bawapin (Dawei)	31.08.2014				170 000
		N/C	Bawapin (Dawei)	30.09.2014				170 000
		N/C	Bawapin (Dawei)	31.10.2014				170 000
		N/C	Bawapin (Dawei)	30.11.2014				170 000
		N/C	Bawapin (Dawei)	4				170 000
		N/C	Bawapin (Dawei)	4				170 000

No.	Company	Beneficiary Identity	Beneficiary Location	In Kind payments (Projects)		Cash payment	
				Date	Description of the projects (activities undertaken, beneficiaries, objectives..)	Amount (USD)	Amount (MMK)
		N/C	Bawapin (Dawei)	31.12.2014			170 000
		N/C	Bawapin (Dawei)	31.01.2015			170 000
		N/C	Bawapin (Dawei)	28.02.2015			170 000
		N/C	Bawapin (Dawei)	31.03.2015			170 000
8	Eternal Mining Co., Ltd	N/C	N/C	N/C	N/C	N/C	148 509 000
9		1	Pyin Ma Taw Village, Yamethin Township	11/11/2014	Donation for the Shwe Taung Gyi Bridge Construction (50'x24'x30')	N/A	170 000 000
		2	Ngar Tae Su Village, Yamethin Township	3/13/2015	Donation for the Ngar Tae Su Bridge Construction (30'x21'x11')	N/A	50 000 000
		3	Shwe Mine Village, Moedi Moemi Region	31/03/2015	Donation for the Public Pond at Shwe Mine Village (40'x20'x15')	N/A	117 133 300
		4	Ngar Tae Su Village, Yamethin Township	6/16/2016 .29/6/2016 12/11/2014	Donation for the Electrical Installation at Ngar Tae Su Village	N/A	30 511 635
	National Prosperity Gold Production Group Ltd.	5	Pyin Ma Taw Village, Yamethin Township	05/08/2014	Donation for Library at Pyin Ma Taw Village	N/A	1 200 000
		6	Yame Thin Township	7/28/2014	Donation for Outstanding Students Awarding Ceremony	N/A	6 000 000
		7	Shwe Mine Village, Moedi Moemi Region	5/162014, 9/5/2014 10/2/2014 ,12/22/2014	Donation for Supply of Medical Equipments and Medicines at Shwe Mine Village Clinic	N/A	8 421 134
		8	Yame Thin Township	01/05/2014	Donation for the Construction of Thilawa Town hall at Yamethin Township	N/A	5 000 000
		9	Yame Thin Township	07/05/2014	Donation for YamethinTownship Sport Committee	N/A	500 000
		10	Yame Thin Township	01/05/2015	Donation for YamethinTownship Fire Fighting Department	N/A	500 000
		11	Yame Thin Township	7/28/2014	Donation for Poverty Alleviation	N/A	20 000 000

No.	Company	Beneficiary Identity	Beneficiary Location	Date	In Kind payments (Projects)	Cash payment	
					Description of the projects (activities undertaken, beneficiaries, objectives..)	Amount (USD)	Amount (MMK)
		12	Nay Pyi Taw	01/01/2015	Donation for a Viss of Refined Gold to Nay Pyi Taw Oat Parada Sandi Pagoda	N/A	70 000 000
		13	Yame Thin Township	05/01/2014	Donation for Dining Building and Toilet at Yamethin Sha Sa Na Building	N/A	20 000 000
		14	Myit Kyi Na Township	10/09/2014	Donation for Dining Building at Moat Khoe Taung Monastery	N/A	1 200 000
10	Myanmar Golden Point Family Co., Ltd.	N/C	N/C	N/C	N/C	N/C	239 793 200
11	THAN TAW MYAT CO,LTD	Local People	Mhine Pan Village, Kyaukse Tsp, Mandalay Region	N/A	Renovation of rural Development Road and water drain. (14.8.2014)	N/A	23 100 000
		Local People	Shan Taung Oo Village track Clinic, Kyaukse Tsp, Mandalay Region	N/A	Medical Equipments. (26.12.2014)	N/A	1 000 000
		N/C	N/C	N/C	N/C	N/C	919 548 681
12	Delco Co.,Ltd	1	Kanbauk Village, Yayphyu Tsp, Tanintaryee Region.	2014-2015	Donation for the rural development of Kanbauk		8 143 000
		2	Kanbauk Village, Yayphyu Tsp, Tanintaryee Region.	2014-2015	Donation for the sand, wages, cars and vehicles		8 040 000
13	Myanmar Pongpipat Co.,L td	N/C	N/C	N/C	N/C	N/C	47 290 000
Total							12 192 922 697

Appendix 16: Extractive Revenues 2014-2015 disaggregated by revenue streams

Company	Total (In million MMK)	%
Oil and Gas	2,353,608.47	69.98%
TOTAL	941,466.37	27.99%
Petronas Carigali Hong Kong Ltd (PCML)	757,187.81	22.51%
Daewoo International Corporation	399,350.29	11.87%
PTTEP International Ltd.	185,253.19	5.51%
Petronas Carigali Myanmar Inc (PCMI)	26,222.22	0.78%
Unocal Myanmar Offshore Co., Ltd	22,421.31	0.67%
Nippon Oil	11,938.85	0.35%
Goldpetrol Co Ltd	7,358.67	0.22%
MPRL E&P Pte Ltd	1,313.84	0.04%
PTTEP South Asia Ltd	874.66	0.03%
Goldpetrol Co Ltd	158.80	0.00%
Woodside Energy Pte. Ltd.	62.20	0.00%
Ophir Myanmar Ltd	0.28	0.00%
Oil and Gas transportation	497,771.61	14.80%
Moattama Gas Transportation Company (MGTC)	258,694.20	7.69%
Taninthayi Pipeline Company (TPC)	229,300.10	6.82%
South-East Asia Gas Pipeline Co (SEAGP)	9,777.31	0.29%
Gems and Jade	387,029.20	11.51%
Myanmar Win Gate Gems & Jewellery Mining	29,388.40	0.87%
Yar Za Htar Ne Gems Co;Ltd. (*)	16,445.97	0.49%
Sein Lom Taung Tan Gems Ltd. (*)	15,433.80	0.46%
Myanmar Imperial Jade(Gems & Jewellery) (*)	10,618.65	0.32%
Wai Aung Gabar Gems Co; Ltd. (*)	9,368.66	0.28%
Ayar Jade Co; Ltd.	8,906.17	0.26%
Yadanar Kaung Kin Gems & Jewellery Co;Ltd	7,703.42	0.23%
Myat Yamon Gems Co;Ltd. (*)	7,546.65	0.22%
Kyauk Seinn Nagar (Gems) (*)	7,310.22	0.22%
Myanmar Sithu Jewellery (*)	7,135.68	0.21%
Linn Lett Win Yadanar Gems (*)	6,701.03	0.20%
Yadanar Taung Tann Gems (*)	4,636.44	0.14%
Khin Zaw Aung & Brothers Gems & Jewellery (*)	4,630.11	0.14%
Shwe Gaung Gaung Gems	3,985.77	0.12%
Xie Family (*)	3,538.74	0.11%
Great Genesis Gems Co; Ltd. (*)	3,180.47	0.09%
Richest Gems Co;Ltd. (*)	2,921.05	0.09%
Kyaing International Gems (*)	2,893.32	0.09%
RUBY DRAGON JADE & GEMS Co.,Ltd	2,852.82	
Khun Pa-Oh Gems & Jewellery	2,815.63	
Myanma Seinn Lei Aung Gems	2,794.84	

Company	Total (In million MMK)	%
Khine Myanmar Gems Co;Ltd.	2,754.13	0.08%
Phyo Thiha Kyaw Gems	2,718.36	0.08%
Jade Mountain Gems Co;Ltd. (*)	2,717.95	0.08%
Myo Nwe Gems & Jewellery	2,701.40	
Silver Elephant Gems	2,366.05	
SHWE BYAIN PHYU CO	2,342.21	0.07%
Shining Star Light Gems & Jewellery (*)	2,241.51	
Kyaw Naing & Brothers	2,178.39	0.06%
Tun Naing Aung Gems	2,049.13	
Thi Raw Mani Gems & Jewellery (*)	2,014.46	
Chaow Brothers Gemstone	1,910.83	
Yadanar Pyi Phyo Aung Gems And Jewellery Co; Ltd.	1,692.84	
PAING PHYO THIIHA GEMS	1,670.63	
Myanmar Naing Group	1,646.80	
Ever Winner Gems (*)	1,632.02	0.05%
Pho Thar Htoo Gems Co; Ltd.	1,630.46	
(1.1.1) Gems & Jewellery (*)	1,599.33	
Lyan Shan Jewellery Co; Ltd.	1,509.08	
HTOO JEWELLERY CO.,LTD.	1,406.31	0.04%
Kachin National Development	1,390.14	
Ngwe Hein Htet Gems & Jewellery	1,370.18	
Pang Huke Duwa Co; Ltd.	1,256.57	
EIGHTY THOUSAND GEMS & JEWELLERY Co;Ltd	1,143.85	
Jade Padathar Gems + Shwe Gaung Gaung Gems	1,136.71	0.03%
Kan Pwint Oo	1,083.42	0.03%
Mann Ayer Family Co.,Ltd.	1,071.52	
Oo Ya Gems & Jewellery Co;Ltd.	1,047.42	
Aung Hein Min Gems Co.,Ltd	949.12	0.03%
Yadanar San Shwin Gems Co., Ltd	942.22	0.03%
Than Lwin Aye Yar Gems Co., Ltd. (Kaung Myat Thu Kha Co. Ltd)	909.87	0.03%
Myanmar Economics Corporation	823.38	
KHA YANN MYAY GEMS	795.29	0.02%
Kyauk Gyi Gone Gems & Jewellery Co., Ltd	787.26	0.02%
Kan Par Ni Gems & Jewellery Co.,Ltd.	622.33	
YadanarYaungChi Gems Co,Ltd	610.30	0.02%
Kyaw Thet Aung	550.00	0.02%
Lin Yaung Phyar Gems Co.,Ltd	532.97	0.02%
Zwe Htet Lwin Gems & Jewellery Co.,Ltd	486.15	0.01%
Tun Tauk Sa Gems Co.,Ltd.	463.99	0.01%
Golden Grate Wall Gems Co., Ltd	335.81	0.01%
Golden Wallet Jewellery Co.,Ltd	258.16	0.01%
Phar Kant Yar Zar Gems & Jewellery Co.,Ltd	253.78	0.01%
Big Jade Gems Co.,Ltd.	143.58	0.00%
Kyay Lin	98.43	0.00%
NILAR YOMA TRADING	43.06	0.00%
Kaung Wai Yan Gems Co,Ltd	33.23	0.00%

Company	Total (In million MMK)	%
Thit Sar Pan (U Kyaw Min Naing) (private)	7.56	
Unilateral Disclosure	168,293.17	5.00%
Other minerals	124,848.12	3.71%
Myanmar CNMC Nickel Co; LTD (*)	49,457.22	1.47%
Myanmar Yang Tse Copper Ltd (*)	8,642.03	0.26%
Win Myint Mo Industries Co.,Ltd (*)	2,153.74	0.06%
NgweYi Palae Mining Co.,Ltd (*)	1,435.97	0.04%
Eternal Mining Co., Ltd (*)	1,385.71	0.04%
Delco Co.,Ltd (*)	986.43	0.03%
Shwe Taung Mining Co., Ltd.	907.03	0.03%
National Prosperity Gold Production Group Ltd.	607.34	0.02%
GPS Joint Venture Co., Ltd. (*)	438.14	0.01%
Tha Byu Mining Co.,Ltd (*)	363.17	0.01%
Max Myanmar Industry Co.,Ltd (*)	336.21	0.01%
Myanmar Golden Point Family Co., Ltd.	333.24	0.01%
Myanmar Pongpipat Co.,L td (*)	323.21	0.01%
Tun Thwin Mining Co., Ltd	288.18	0.01%
Shwe Moe Yan Co.,Ltd	268.66	0.01%
Electrum Mining Co; Ltd	257.49	0.01%
Ruby Dragon Mining Co., Ltd.	168.70	0.01%
Htoo International Industrial Gorup Co.,Ltd	108.31	
Sea Sun Star Mining Production & Marketing Co.,Ltd	105.57	0.00%
THAN TAW MYAT CO,LTD	92.71	0.00%
Kayar Mine Production Co., Ltd	86.68	0.00%
Ye Htut Kyaw Mining Co.,Ltd	83.89	0.00%
BAGAN BUSINESS GROUP	71.71	0.00%
Aung Brother Mining Co;Ltd	43.30	0.00%
Eastern Mining Co.,Ltd	26.50	0.00%
Swan Min Htet Mining Co;Ltd	19.34	0.00%
Swan Yadanar Htay Mining Co;Ltd	18.95	0.00%
Geo Asia Industrial and Mining Co., Ltd.	6.61	0.00%
Myanma Economic Corporation	5.58	0.00%
Sales of the State share of production	30,390.73	0.90%
Unilateral Disclosure	25,435.78	0.76%
Pearl	102.15	0.00%
Total	3,363,360.56	100.00%

Appendix 17: Extractive Revenues 2014-2015 disaggregated by company

Sub-sector	Tax revenues	Non-tax revenues	Social contribution	Total (In million MMK)	%
Oil and Gas	148,794.26	2,200,004.63	4,809.58	2,353,608.47	69.98%
Income Tax (IT)	125,339.03	-		125,339.03	3.73%
Stamp Duties	96.70	-		96.70	0.00%
Withholding tax	23,301.34	-		23,301.34	0.69%
Commercial Tax on Imports	55.27	-		55.27	0.00%
Customs Duties on imports	1.92	-		1.92	0.00%
Royalties	-	393,051.69		393,051.69	11.69%
Production Split (State share- Gas&Oil sales)	-	1,403,766.38		1,403,766.38	41.74%
Data fee		939.90			
Production Bonus	-	4,502.21		4,502.21	0.13%
MOGE share (Profit and Cost- G&O sales)		397,744.44		397,744.44	11.83%
Voluntary Corporate Social Responsibility			4,809.58	4,809.58	0.14%
Oil and Gas transportation	295,451.96	197,819.59	4,500.07	497,771.61	14.80%
Income Tax (IT)	295,427.87	-	-	295,427.87	8.78%
Withholding tax	24.08	-	-	24.08	0.00%
Customs Duties on imports	-	-	-	-	0.00%
Land fees/Dead rent fee	-	995.26	-	995.26	0.03%
Dividend/Profit Sharing on Oil & Gas transportation	-	187,126.46	-	187,126.46	5.56%
Road right fee Oil & Gas transportation (Right of way)	-	9,697.87	-	9,697.87	0.29%
Voluntary Corporate Social Responsibility	-	-	4,500.07	4,500.07	0.13%
Gems and Jade	55,681.98	331,329.34	17.89	387,029.20	11.51%
Income Tax	4,852.78	-		4,852.78	0.14%
Commercial Tax	15,014.41	-		15,014.41	0.45%
Custom Duties	7,914.10	-		7,914.10	0.24%
Withholding Tax	619.46				
Royalties on Sales	27,281.23	-		27,281.23	0.81%
Emporium Fees / Sale Fees		12,775.08			
Royalties on production - 20% collected by/paid to MGE	-	7,279.75		7,279.75	0.22%
Sale Split - 40%	-	122,866.10		122,866.10	3.65%
Royalties on Sales- 7%	-	68,723.14		68,723.14	2.04%
Service Fees - 3%, 1%	-	29,568.66		29,568.66	0.88%
Permit fees	-	81,902.76		81,902.76	2.44%
Incentive fees 1%, 2%	-	2,919.60		2,919.60	0.09%
Other significant payments (> 50,000 USD) MGE	-	5,294.25		5,294.25	0.16%
Voluntary Corporate Social Responsibility			17.89	17.89	0.00%
				-	0.00%
				-	0.00%
				-	0.00%
				-	0.00%
Other Minerals	27,509.69	94,473.05	2,865.38	124,848.12	3.71%
Income Tax (IT)	16,891.84	-	-	16,891.84	0.50%

Commercial Tax	6,947.91	-	-	6,947.91	0.21%
Commercial Tax on Imports	148.94	-	-	148.94	0.00%
Customs Duties	3,230.68	-	-	3,230.68	0.10%
Withholding Tax	72.57	-	-	72.57	0.00%
Capital Gain Tax	217.75			217.75	0.01%
Royalties	-	24,661.88	-	24,661.88	0.73%
Signature Bonus	-	1,453.11	-	1,453.11	0.04%
Production Split	-	31,994.97	-	31,994.97	0.95%
Dead Rent Fees	-	3,732.57	-	3,732.57	0.11%
Licence Fees	-	438.50	-	438.50	0.01%
Land rental fees	-	94.01	-	94.01	0.00%
Other significant payments (> 50,000 USD)	-	1,707.28	-	1,707.28	0.05%
Sales of the State share of production	-	30,390.73	-	30,390.73	0.90%
Mandatory Corporate Social Responsibility	-	-	261.96	261.96	0.01%
Voluntary Corporate Social Responsibility	-	-	2,603.43	2,603.43	0.08%
Pearl	-	102.15	-	102.15	0.00%
Total	527,437.88	2,823,728.76	12,192.92	3,363,360.56	100%

Appendix 18: Reconciliation sheets by company

See excel sheets

Appendix 19: Situaion of the Oil and Gas companies that did not submit Reporting Templates

Sr.	Operator	Block	Signing Date	Period	Remarks
1	Nippon Oil	Share partner of Yetagun Project (PCML)			
2	Jubilant Oil and Gas	PSC I	28-5-2012	Initial Exploration Period	Share transferred to Parami Energy
3	Asia Orient International Co., Ltd	PSC E	14-6-2012	Initial Exploration Period	9-12-2017 Termination process
4	Petro Vietnam	M 2	2-10-2008	Initial Exploration Period	Relinquished (30-9-2017)
5	Tap Oil	M 7	26-8-2015	Study Period	29-11-2017 Termination process
6	Reliance Industries Ltd	M 17 / M 18	31-3-2015	Study Period	Relinquished (31-1-2017)
7	CFG	M 15	30-3-2015	Study Period	-
8	Oil India Limited	M4 / YEB	4-12-2014	Study Period	Termination (2-3-2017)

Appendix 20: Bid criteria for the award of the Oil and Gas blocks

See excel sheets

Appendix 21: Participation of ME2 in the mining Joint Ventures

See excel sheets

Appendix 22: Gold in-kind debts of the Other Minerals companies due to ME2 as at 31 March 2015

No	Company Name	State/Region	Liability to Pay In-Kind(Gold) as at 31 March 2015 (in Tical)
1	A May Kyay Zuu	Kachin State	90.13
2	Thway Mi Thar Su	Kachin State	679.82
3	Shwe Chit Thu	Kachin State	55.81
4	Shwe Chuu Than Thar	Kachin State	68.72
5	Shwe Thaik San	Kachin State	26.00
6	Pin Lae Nay Kyel	Kachin State	154.00
7	Shin Bway Yan Developent	Kachin State	123.34
8	Wai Myaint San Thar	Kachin State	80.34
9	Hein Naing Soe	Kachin State	93.81
10	Shwe Aung Maing	Kachin State	293.91
11	Shw Tar Pain	Kachin State	166.26
12	Aung Thit Lwin	Kachin State	40.63
13	Shwe Win Htet	Kachin State	110.63
14	Yar Hnone Pyae	Kachin State	602.38
15	Khin Yadanar Aung	Kachin State	239.69
16	Pan Myat Mar Lar	Kachin State	65.06
17	Khant Nyar	Kachin State	48.00
18	Kan Kaung Thaw Padonmar	Kachin State	28.50
19	Tun Tun Aung	Kachin State	28.13
20	Shwe Htoo	Kachin State	26.81
21	Shwe Yadanar Soe	Kachin State	20.56
22	Shwe Pin Lae Nat Thamee	Kachin State	25.31
23	Jar Sha Gaung	Kachin State	28.75
24	Swe Yadanar	Kachin State	130.81
25	Aung Phyo Shein Phyo	Kachin State	86.88
26	Myanmar Shwe Yadanar	Kachin State	117.00
27	Lay Kyun Aung Lan	Kachin State	71.75
28	Lat Yway Sin	Kachin State	51.88
29	A Sein Yaung Nae Myay	Kachin State	57.75
30	Shwe Tha Byay Aung	Kachin State	81.44
31	Tein Naga Hna Kaung	Kachin State	83.13
32	Lab Moe Shan	Kachin State	15.63
33	Shwe Lin Mar	Kachin State	81.38
34	Ka Yu Eain	Kachin State	130.50
35	Chan Myae	Kachin State	53.25
36	So Pyay Aung	Kachin State	30.63
37	Htet Wai Phyo	Kachin State	32.81
38	Myauk Paing Thra Phu	Kachin State	27.75
39	Nothern Star	Kachin State	33.28
40	Sein Myat Mon	Kachin State	15.94
41	Yadanar Lae Myay	Kachin State	7.50
42	Shwe Win Wa	Kachin State	7.50
43	Shwe Myanandar	Kachin State	22.39
44	Thein Than Thu	Kachin State	136.75
45	Aung Myint San	Kachin State	68.31
46	Sann Lin	Kachin State	290.77

No	Company Name	State/Region	Liability to Pay In-Kind(Gold) as at
47	Mya Koe Thwe	Kachin State	24.00
48	Shwe Pyi Sat Kyar	Kachin State	7.00
49	Kyauk Sein Ba Yin	Kachin State	4.00
50	Yadanar Son Hmat	Kachin State	14.00
51	Arr Lat Yone	Kachin State	32.00
52	Kabar Chay Lnn	Kachin State	76.00
53	Shwe Kho Wai	Kachin State	8.00
54	Aung Myin Thu	Kachin State	4.00
55	Kaung Myat Pyae Sone	Kachin State	43.38
56	Moe Thauk Kyal Min	Kachin State	20.44
57	Shwe Zabau	Kachin State	13.88
58	Shwe Ka War	Kachin State	23.00
59	Aung Ngwe Oo	Kachin State	44.00
60	Ocean Princess	Kachin State	95.63
61	That Tu Sein	Kachin State	73.13
62	Thein Htat Hlan	Kachin State	107.50
63	Aung Pwe Win	Kachin State	61.25
64	Htet Kaung Kyaw	Kachin State	232.75
65	Htin Paw Kyaw Kyar	Kachin State	223.44
66	Jade Lin	Kachin State	582.81
67	Twe San	Kachin State	53.31
68	Phyo Wai Thiri	Kachin State	124.13
69	Myanmar New Win	Kachin State	84.94
70	Myanmar Augn Moe Hein	Kachin State	15.00
71	Myanmar Moe Thauk Kyal	Kachin State	42.09
72	Myanmar Shwe Yadanar Heing	Kachin State	9.38
73	Myanmar San Taw Win	Kachin State	78.00
74	Ma Naw Yadanar	Kachin State	34.69
75	Shwe Yadanar Shwe	Kachin State	39.06
76	Myanmar Swan Pa Kar	Kachin State	62.00
77	Shwe Moe Thwin Aaung	Kachin State	42.00
78	Ant Bwe Kabar	Kachin State	26.25
79	Shwe Ti Htaike	Kachin State	14.00
80	Ma Har Shwe Zabau	Kachin State	22.48
81	Myak Paing Taw Win Myay	Kachin State	27.75
82	Zay Yar Hlaing	Kachin State	168.38
83	Shwe Won Paung	Kachin State	59.31
84	Na Mu Nar San Pya	Kachin State	24.00
85	Shwe Sin Taung	Kachin State	2.00
86	Shwe Nagar Min	Kachin State	2.00
87	Moe Thauk Kyal Thit	Kachin State	32.81
	Total in Kachin State		7,385.41
1	Yadanar Chintwinn	Sagaing Division	381.22
2	Sein Htet Win	Sagaing Division	24.30
3	Muu Myit Phyar	Sagaing Division	62.72
4	Shwesin Gabar	Sagaing Division	24.72
5	ShweYaung Kaung Thaww Mate Swe	Sagaing Division	201.84
6	Ahant Phwel Gabar	Sagaing Division	115.86
7	Shwe Sin Hein	Sagaing Division	64.53
8	Myanmar Shwetheinggi	Sagaing Division	28.32

No	Company Name	State/Region	Liability to Pay In-Kind(Gold) as at
9	Mandalay Mining	Sagaing Division	335.13
10	ShweMya Nandar	Sagaing Division	141.55
11	Moe Hein Htun	Sagaing Division	47.07
12	Shan Katuu	Sagaing Division	404.16
13	Htay Win Htun	Sagaing Division	268.27
14	Moekyoe Chintae	Sagaing Division	101.02
15	Kan Kaung Chin Htar Wara Ahar Man	Sagaing Division	179.38
16	Thalar Shwe Sin	Sagaing Division	190.20
17	Kitsanna Daewi	Sagaing Division	60.55
18	Seinn Shwe War Nadi	Sagaing Division	250.91
19	Htar Nay Aung	Sagaing Division	142.56
20	Phyu War Yaung Shwe	Sagaing Division	89.47
21	Shwe Wa D	Sagaing Division	686.83
22	Shwe Zayti Sate	Sagaing Division	262.76
23	Shwe Nanthar Aung	Sagaing Division	141.78
24	Shwe Latpan Thar	Sagaing Division	172.44
25	Shwe Tat Hein	Sagaing Division	106.35
26	Yadanar Laire Myay	Sagaing Division	108.84
27	Lin Lae Seinn	Sagaing Division	152.61
28	Winn War Shwesin	Sagaing Division	176.75
29	Winn Ayarwaddy	Sagaing Division	207.81
30	Waine Myint Myat	Sagaing Division	35.00
31	That Tu Seinn	Sagaing Division	130.93
32	Theinggi Shwesin	Sagaing Division	36.23
33	Thar Loon	Sagaing Division	58.28
34	Hein Naing Soe	Sagaing Division	109.03
35	Shwe Pwarr	Sagaing Division	105.49
36	Aung Zay Ya Tin Htun	Sagaing Division	34.08
37	Hein Yarzar	Sagaing Division	110.05
38	A Kaung Sone Shwe	Sagaing Division	9.38
39	Htun Yan Naing	Sagaing Division	35.64
40	Hnin Yaung Myay	Sagaing Division	17.94
41	Shwe Winn Htun Aung	Sagaing Division	193.23
42	Shwe Chintwinn	Sagaing Division	105.71
43	Shwe Tha Pyay Moe	Sagaing Division	29.33
44	Shwe Toe Tat Aung	Sagaing Division	19.16
45	Shwe Swe Htun	Sagaing Division	49.06
46	Shwe Tar Pain	Sagaing Division	41.98
47	Shwe Wint War Aung	Sagaing Division	37.17
48	Win Hnint Pyae Phyo	Sagaing Division	188.97
49	Minn Winn Soe	Sagaing Division	43.60
50	Shwe Ngu War Shwe	Sagaing Division	54.59
51	Shwe Seinn Mya	Sagaing Division	123.45
52	Shwe Tan Tayng Myauk Pine	Sagaing Division	81.72
53	Shwe NweKham	Sagaing Division	19.44
54	Wai Aung Myint San	Sagaing Division	129.49
55	Aung Thukha Linn	Sagaing Division	53.40
56	Myanmar Seepwar Sat	Sagaing Division	20.62
57	Ayarwaddy Myit phyarr	Sagaing Division	107.16
58	Shwe Pyae Hlan	Sagaing Division	37.29

No	Company Name	State/Region	Liability to Pay In-Kind(Gold) as at
59	Shwe Pyi San Aung	Sagaing Division	12.44
60	Soe Htet Wai	Sagaing Division	45.43
61	Shwe Taww	Sagaing Division	6.00
62	Pann Myat Mar Lar	Sagaing Division	27.63
63	Aung Zabu Riz	Sagaing Division	24.00
64	Bo Thaing Hnint Nyi Myarr	Sagaing Division	7.89
65	Sat Tha Khu Myauk Kyal	Sagaing Division	39.28
66	Wiyiya Sat Hmu	Sagaing Division	67.20
67	Linn Phyo	Sagaing Division	24.00
68	Shwe Toe	Sagaing Division	10.00
69	Shwe Oak Soe	Sagaing Division	4.26
	Total in Sagaing Division		7,415.50
1	Shwe Myanandar	Thabake Kyinn Tsp	34.55
2	Sein Htee Nann	Thabake Kyinn Tsp	65.13
3	Houng Tar	Thabake Kyinn Tsp	18.59
4	Wai Yan Oo	Thabake Kyinn Tsp	82.50
5	Aung Shwe Ngarr	Thabake Kyinn Tsp	13.13
6	Pyae Phyo Lin Khaing	Thabake Kyinn Tsp	26.00
7	Sein War Linn	Thabake Kyinn Tsp	21.57
8	Shwe Thiha Myanmar	Thabake Kyinn Tsp	12.39
9	Shwe Seinn Yaung	Thabake Kyinn Tsp	17.48
10	Htar Wa Ra	Thabake Kyinn Tsp	48.00
	Total in Thabake Kyinn Tsp		339.34
1	Nilar Hnin Cee	Sintku Tsp	202.50
2	San Winn Metharhsu	Sintku Tsp	45.00
3	Tar Naw Htoo	Sintku Tsp	54.00
4	Yar That San	Sintku Tsp	45.00
5	TheinggiAung	Sintku Tsp	38.90
6	Aung Nann Tha Ya Phu	Sintku Tsp	24.00
7	Sein HtayShwe	Sintku Tsp	45.00
8	Shwe Sitthi	Sintku Tsp	10.30
9	Yadanar Iare Myay	Sintku Tsp	346.92
10	Silver Wave	Sintku Tsp	29.98
11	Htet Yay Linn	Sintku Tsp	1.32
12	Myittar Shin	Sintku Tsp	16.88
	Total in Sintku Tsp		859.80
1	Yangon Kyal Ni	Shan State	32.00
2	Sein Myay International	Shan State	6.00
3	Aung Naing	Shan State	128.75
4	khu nit Khu Thaww Yarzu	Shan State	23.13
5	Aung Sitt Twayy	Shan State	23.13
6	Shwe Kywel	Shan State	86.25
7	Htet Kaung Kyaw	Shan State	23.13
8	A.S.A Mining	Shan State	56.88
9	Yarza Min Shwe	Shan State	48.00
10	Myanmar Ruby Enterprise	Shan State	70.00
11	Htun Tint Shwe War	Shan State	6.00
12	Myanmar Htarwara Tetant Thaww	Shan State	19.00
	Total in Shan State		522.27
1	Sann Lin	Thar Si Tsp	26.88

No	Company Name	State/Region	Liability to Pay In-Kind(Gold) as at
	Total in Thar Si Tsp		26.88
1	Kaung Sathmu Lat Hmu	Ya Mae Thinn Tsp	68.85
2	July Moe	Ya Mae Thinn Tsp	40.43
3	Suu San Lape Lar	Ya Mae Thinn Tsp	44.63
4	Sein Htee Nann	Ya Mae Thinn Tsp	22.88
5	Taww Win Dhana	Ya Mae Thinn Tsp	74.72
6	Pann Myat Yarzar	Ya Mae Thinn Tsp	90.50
7	Pan Pwint	Ya Mae Thinn Tsp	92.94
8	Shwe Yaung Kaung Kin	Ya Mae Thinn Tsp	53.13
9	Shwe Ya Aung Pyae	Ya Mae Thinn Tsp	49.31
10	Win Myaing	Ya Mae Thinn Tsp	25.88
11	Houng Ta Yaw Aung Myay	Ya Mae Thinn Tsp	14.00
12	Yar MaNya International	Ya Mae Thinn Tsp	60.47
13	Aye Nyein Mon	Ya Mae Thinn Tsp	92.34
14	Ahmyare Hman	Ya Mae Thinn Tsp	35.63
15	Naychi Pwint	Ya Mae Thinn Tsp	13.00
16	Zayar Hlaing	Ya Mae Thinn Tsp	97.50
17	Shwe Pyi Aye	Ya Mae Thinn Tsp	4.00
	Total in Ya Mae Thin Tsp		880.21
1	Moe Lwin	Mon State	21.77
2	Pann Pwint	Mon State	22.50
3	Myanmar Htet Waiyan	Mon State	46.10
4	Aye Mya Pyae Sone	Mon State	180.00
5	Yaung Ni Oo	Mon State	32.54
	Total in Mon State		302.91
1	Chit Linn Myaing	Kayin State	590.50
2	Audann Thit	Kayin State	310.00
3	Mya Htay Kwel Linn	Kayin State	1,283.32
4	Myat eindray	Kayin State	1,364.14
5	Kyaw Hlwan Moe	Kayin State	402.50
6	Shwe Aung Thu	Kayin State	343.75
7	San Pya Shwe	Kayin State	195.00
8	United KMK	Kayin State	292.50
9	Shwe Kyinn Tharr	Kayin State	22.50
10	Yadanar Minn	Kayin State	32.50
11	Aye Ko Mi thar Su	Kayin State	650.00
	Total in Kayin State		5,486.71
1	Zabuu Riz	Bago Division	343.31
2	Khing Shwe Nyein Aye	Bago Division	58.12
3	Yoma Thit	Bago Division	41.28
4	Soe Yadanar Linn	Bago Division	52.50
5	Myanmar Bo Bo	Bago Division	9.38
6	Shwe Kyunn Gyi	Bago Division	99.38
7	Shwe Kyinn Tharr	Bago Division	364.18
8	Khamm Warr	Bago Division	102.01
9	Myat eindray	Bago Division	331.88
10	Aung Myin Chan Thar	Bago Division	65.63
11	Mya Sein Yaung Kyunn	Bago Division	9.75
12	Golden Target	Bago Division	55.75
13	Aye Mya Pyae Sone	Bago Division	241.88

No	Company Name	State/Region	Liabilitiy to Pay In-Kind(Gold) as at
	Total in Bago Division		1,775.05
1	Shwe Phone Thit	Thanintharyi Division	48.83
2	Shwe Sin Taung	Thanintharyi Division	15.83
	Total in Thanintharyi Division		64.66
1	Htar Wara (A Kyi Sarr)	Sagaing Division	5,754.84
	Grand Total		30,813.58

Appendix 23: Persons contacted or involved in the 2014-2015 MEITI reconciliation

Persons involved

Moore Stephens LLP	
Tim Woodward	Partner
Ben Toorabally	Head of Office / Mission Director
Karim Lourimi	Senior Manager/Head of Mission
Elyes Kooli	Audit Supervisor
Sami Sakka	Audit Senior
Hamdi Tayaa	Audit Senior
Lisa Saw	Audit Senior
Sub-contractors	
Cho Cho Toe	Local consultant
Daw Tin Myo Thu Zar	Local consultant

Persons contacted

MEITI National Coordination Office (NCS) / MEITI Office (MoPF)	
U Soe Win	National Coordinator
U Aung Khine	Deputy National Coordinator
Daw Zin Mar Myaing	Programme Manager
Daw Tar Yar Maung	Technical advisor

Ministry of Electricity and Energy (MOEE)	
U Myo Myint Oo	Managing Director, MOGE
U Than Htay Aung	MEITI-MSG Alternate / Expert (MoGE)
Daw Kyi Kyi Pyone	Deputy Director, Finance
Daw Nu Nu Yi	Deputy General Manager (Onshore Department)
U Nay Aung	Manager (Offshore Department)
Daw Myint Myint Khaing	Assistant Manager (Offshore Department)
Daw Win Win Kyu	Deputy Director, Oil and Gas Planning Department
Daw Su Su Soe	Assistant Director, Oil and Gas Planning Department

Ministry of Natural Resource and Environmental Conservation (MONREC)	
U Win Htein	Deputy Chair of MEITI-MSG/Experts, Department of Mines
U Khin Latt Gyi	Director General, Department of Mine
U Kyaw Thet	MEITI-MSG / Deputy Director General, Department of Mines
U Tun Tun Lwin	Director, Mining Enterprise 1
Daw Ma Kyawt	Staff officer, Mining Enterprise 1
U Aye Zaw	Director, Mining Enterprise 2
U Ye Myo Min	Senior Engineer, Mining Enterprise 2
Dr Ye Myint Swe	Director General, Department of Geological Survey and Mineral Explorer
Dr. Zaw Linn Aung	Director, DGSE
U Thein Tun	Assistant Director, Department of Mines
Daw Soe Sandar Maung	Staff officer, Department of Mines
U Myo Naing	Director, Myanmar Gems Enterprise
U Minn Thu	Deputy Director, Myanmar Gems Enterprise
U Hla Aung	Assistant Director, Myanmar Gems Enterprise
Daw Kyu Kyu Win	Assistant Deputy Director, Myanmar Gem Enterprise
U Htun Htun Zaw	Assistant Deputy Director, Myanmar Gem Enterprise

Ministry of Natural Resource and Environmental Conservation (MONREC)	
U Myint Thu	General Manager, Myanmar Pearl Enterprise
U Tay Zar Linn	Deputy General Manager, Myanmar Pearl Enterprise
U Tin Htun	Director, Planning and Statistic Division, Forest Department
U Win Naing	Deputy Director, Planning and Statistic Division, Forest Department
Daw Aye Aye Nyein	Deputy Director, Finance Division, Forest Department
Ministry of Planning and Finance	
U Maung Maung Win	Deputy Minister
DICA, Ministry of Planning and Finance	
U Aung Naing Oo	Director General, DICA
U San Myint	Deputy Director General, DICA
Central Statistic Organization, Ministry of Planning and Finance	
Dr Wah Wah Maung	Acting Director General, Central Statistic Organization
Daw Khin Aye Mu	Deputy Director, Planning Department
Budget Department, Ministry of Planning and Finance	
U Aung Myat Kyaw	Director (SEE, Budget Department)
Daw Yee Yee Win	Deputy Director (SEE, Budget Department)
Daw Lwin Lwin Khaing	Deputy Director (MEITI office, Budget Department)
MEITI office, Budget Department, Ministry of Planning and Finance	
Daw Khin Khin Lwin	Director (MEITI office, Budget Department)
U Sann Win	Deputy Director (MEITI office, Budget Department)
Daw Hnin Wai Aung	Assistant Director (MEITI office, Budget Department)
Daw Khin Pa Pa Khaing	Assistant Director (MEITI office, Budget Department)
Daw Thin Thin Aung	Staff Officer (MEITI office, Budget Department)
Daw Shwe Yee Win	Staff Officer (MEITI office, Budget Department)
Internal Revenue Department, Ministry of Planning and Finance	
Daw Mya Mya Ohn	Deputy Director General, IRD
U Nay Linn Soe	Director, IRD
Ma Ei Ni Tar	Staff Officer, IRD
Daw Min Min Khaing	Assistant Director, IRD
Treasury Department, MoPF	
Daw Ye Ye Khaing	Director (Treasury Department)
Daw Lwin Lwin Khaing	Deputy Director (Treasury)
Customs Department, Ministry of Planning and Finance	
U Kyaw Htin	Director General, Custom Department
U Maung Maung Htwe Swe	Director, Custom Department
U Than Swe Tint	Assistant Director, Custom Department
U Zaw Zaw	Staff Officer, Custom Department
Auditor General Office	
Daw Naing Thet Oo	Director General
Daw San San Win	Deputy Director General
Daw Khaing Khaing Ag	Deputy Director General
Daw Htar Yee	Director
Daw Si Si Chain	Director
Daw Kyi Khin May	Deputy Director (Oil and Gas)
Daw Hla Than	Deputy Director (Natural Resources)
Daw Mary	Assistant Director
Daw Kywat Kywat Htun	Assistant Director